



Product Catalogue 2020 (First Edition)  
AUSTRALIA'S LED LIGHTING SPECIALIST





# HANECO

## LIGHTING

### **Australia's LED Lighting Specialist**

Haneco Lighting is a leading designer of light-emitting diode (LED) lighting products, including related fittings and components. Winners of the 2014 Fast Movers SA Award for our rapid growth, in the last decade alone, we've grown from just three to nearly 100 enthusiastic lighting professionals in the areas of research and development, technical support, shared services, marketing and sales.

Headquartered in Adelaide, we have offices and warehouses in Brisbane, Sydney, Melbourne and Perth.

With 'Innovation' at the core of our values, Haneco invests heavily in Research & Development to not just keep up with the latest technology and design trends, but to set the pace for the whole industry. Our motto, 'Ideas that shine', is exemplified by our smarter LED product range designed for residential, commercial and industrial applications, comprising a wide variety of luminaires with features such as switchable wattage and colour temperature, automatic sunlight utilisation, adjustable auto-dimming, and emergency lighting capabilities.

By engaging Haneco as your lighting supplier, you'll benefit from the highest level of before and after-sales support and easy access to a full complement of local lighting designers and support engineers dedicated to providing you with the level of customer service you deserve.

Thank you for browsing our Trade Catalogue. We trust you'll enjoy what you see and look forward to speaking with you soon.

Office layout sample: utilizing 28 watt panel (1200 x 300)  
maintained  $A_v = 324 \text{ lux}$ ,  $M_f = 0.8$ ,  $U = 0.54$





## Lighting Design

With highly qualified specialists backed up by an experienced team working with up-to-the-minute industry standard software, Haneco's lighting design team is more than capable of providing the best and most cost-effective lighting solution.

The team has the breadth of technical know-how to be able to deal with any lighting problem. They consult onsite or design with provided measurements. With their detailed product knowledge and working understanding of Australian standards and building codes, they provide solutions that satisfy a whole range of criteria.

The easiest of these to satisfy in any retrofit is energy saving. The nature of LED lighting is such that virtually any change from conventional lighting to LED will result in a reduction in power use. The challenge is to maximise that reduction and ensure that spaces are optimally lit.

HANECO's lighting designers are up to the challenge and have over the years proved it by designing major lighting projects for residential, retails and offices, warehouses and public areas.

HANECO's passionate and highly qualified professionals are closely involved with the peak industry bodies IES (Illuminating Engineering Society) and LCA (Lighting Council Australia). They have many years of experience in lighting application and design to bring to the table.



Lighting Design

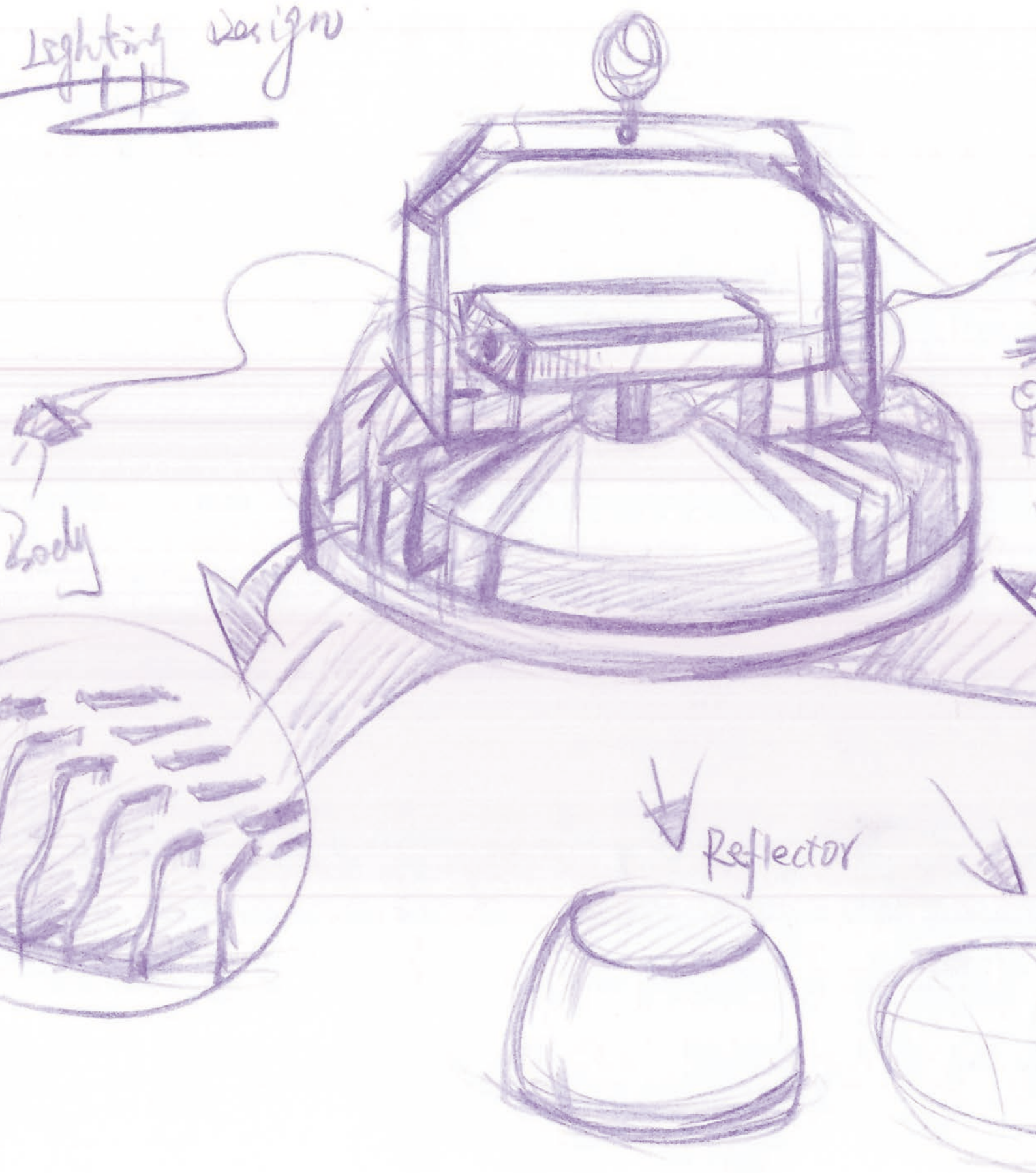

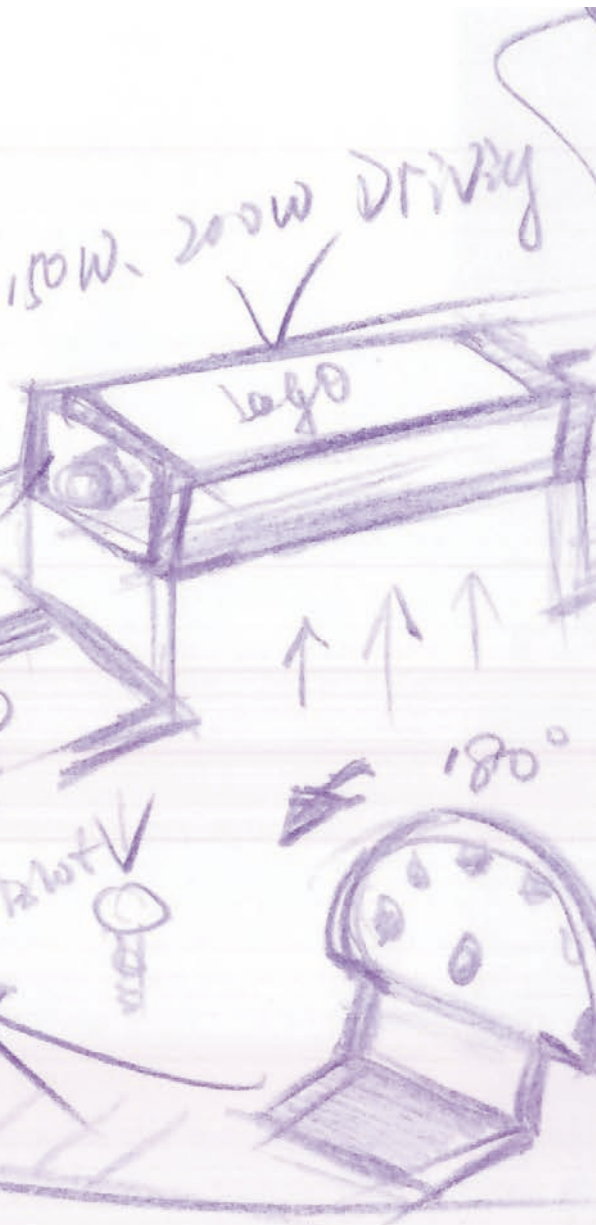

## Research and Development

Haneco is not a company that simply orders and supplies off-the-shelf LED technology. Haneco has a considerable and genuine investment in R&D. LED lighting is a rapidly developing industry where the need to keep pace with improvements in technology is crucial.

Haneco's product development team keeps abreast of the advances in solid state lighting to ensure that products continue to improve in line with market expectations. Refinements to existing products are regularly introduced to increase efficiency and performance and those refinements are based on practical local knowledge and feedback from contractors. Ease of installation is always taken into consideration as well as all the technical details that impact a luminaire's operation.

Redesigning a product requires not only excellent technical proficiency but a close understanding of the circumstances in which the product is typically used. Haneco's team has the necessary skills and local experience to do this.

As Haneco's business grows, its product team and investment in R&D are expanding due to their strong commitment to the principles of quality, service and attention to detail, which allows us to achieve unique and dynamic outcomes that are second to none.



# END TO END PROJECT SOLUTION

When it comes to choosing a lighting solution, it can be difficult to know the key things you need to be on the lookout for and what it is you are going to need. As such decisions often represent a significant financial commitment, it is of vital importance to partner up with a lighting supplier that will not distract you with jargon, so you can know exactly what is being proposed and fully understand the benefits of the offer.

Haneco Lighting has corporate offices and distribution centres in Sydney, Brisbane, Melbourne, Adelaide and Perth. Our business designs and manufactures LED lighting solutions for distribution via Australia's network of electrical wholesalers.

From R&D to engineering, lighting design and energy saving solutions to nationwide distribution, at Haneco Lighting, we are your one-stop full service provider.





### **Bespoke Solutions**

Our local engineers tailor solutions to suit your specific needs through a professionally managed development process.



### **Quality Assurance Procedures**

Experience the peace of mind of knowing that our products been rigorously tested for quality and compliance by Haneco and our global component suppliers.



### **Lighting Design Service**

Enjoy the support of an expert team of lighting designers who can deliver your designs quickly and accurately in accordance with Australian Standards.



### **Project Management**

Our dedicated teams of highly efficient professionals will manage the most vital stages of your project including design, quoting, ordering and delivery.

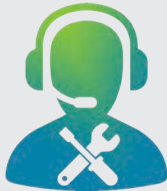

### **Technical Support**

Friendly technical experts, right here in Australia, able and eager to assist you with any enquiry.



### **National Distribution Network**

Fast and efficient delivery throughout Australia and New Zealand.



### **Energy Saving Certification**

Committed to environmental efficiency and a sustainable future, at Haneco Lighting, we have both the experience and the know-how to safely design, develop and deliver energy efficiency solutions ranging from large scale government projects down to the personal needs of individual households.

NB: SA scheme is called REES, Victoria's is VEET and NSW has VEU (aka ESS)



# FEATURED PROJECTS



Bridgeman Baptist Community Church, QLD



West Franklin Apartment, SA





Commercial Office, NSW



Vietnamese Catholic Church, SA



O2 Performance, QLD

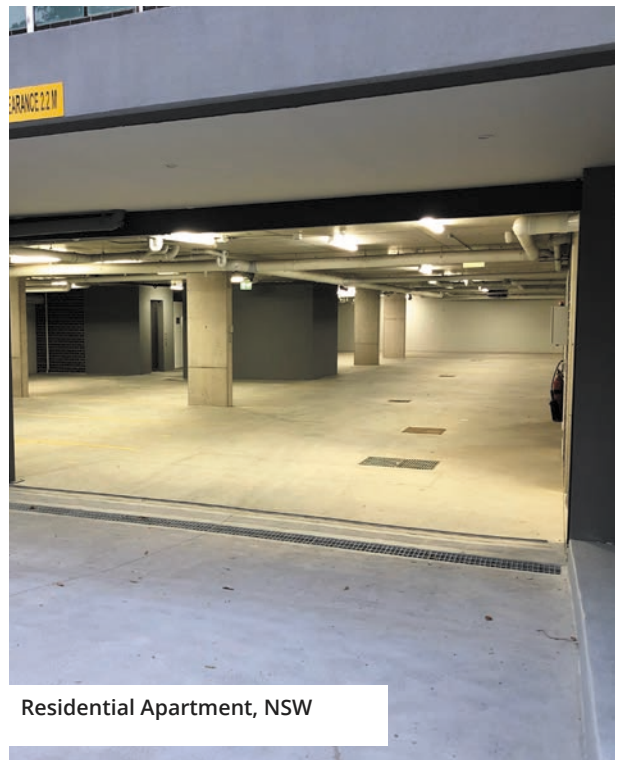

Residential Apartment, NSW

# CONTENTS

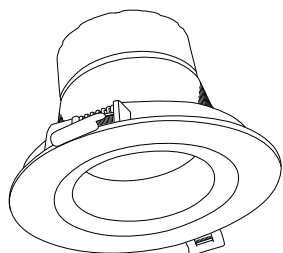

## DOWNLIGHT

VIVA	17
AURORA	21
STELLAR 60	25
DULAR	26
DETAIL	28
DIONE	29
CENTAURI	32
MARS	34
STELLAR	35
CEDAR SNORKEL	37
AURORA SQUARE	39
XBOX	40
CEDAR	41

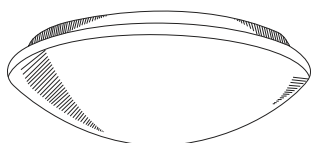

## SURFACE MOUNT

METEOR	48
PURO 300/400	52
PLUTO	54
PURO 350	56
DISCUS	57



## TRACKLIGHT & LED STRIP

FOCI	63
FLEXION	68
PARALLAX	76

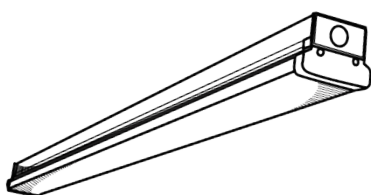

## BATTEN

ATEN	84
VISTALITE	86
VISTA	88
OXFORD	90
BLADE	92
BAREBATTEN	93
DURALITE	96
TRIPROOF	98
SENTRY	101



## PANEL

MATRIX	107
GALAXY	111

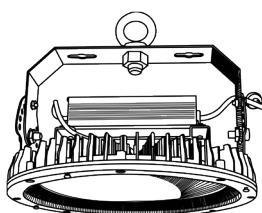

## HIGHBAY & LOWBAY

SKYPAD	120
SUPERNOVA	126
HOODIE	127
MERIDIAN	128
SKYCUBE	131

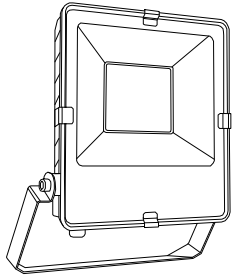

## EXTERIOR LIGHTING

STAX	137
PARX	140
DAWN	144
CALEO	146
PROXIMA	147
ARCHISPOT	148
WALL WASHER	149
MATITA	151

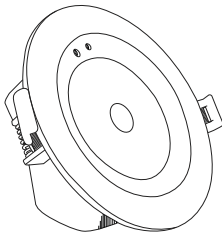

## EMERGENCY LIGHTING

LUME	156
VISTA	158
VISTALITE	160
DURALITE	162
TRIPROOF	162
PURO 400	164
PLUTO	164
DAWN	166

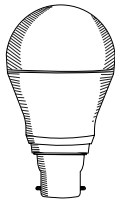

## RETRO FIT

RETRO 7W KIT	170
A60 LAMP	171
PAR 38 LAMP	172
LED TUBE	173

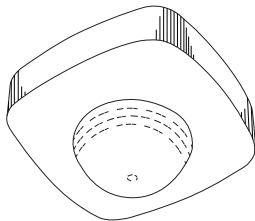

## LIGHTING CONTROL

DUO 350	176
SENTURA	177
INTELLISENSOR	178
SMART LIGHTING CONTROL (KASTA)	184

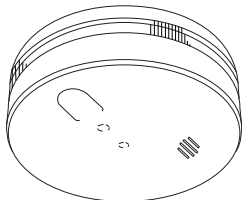

## SECURITY

SMOXE	190
AGILIS	191



## ACCESSORIES

LED DRIVERS REPLACEMENT	194
-------------------------	-----

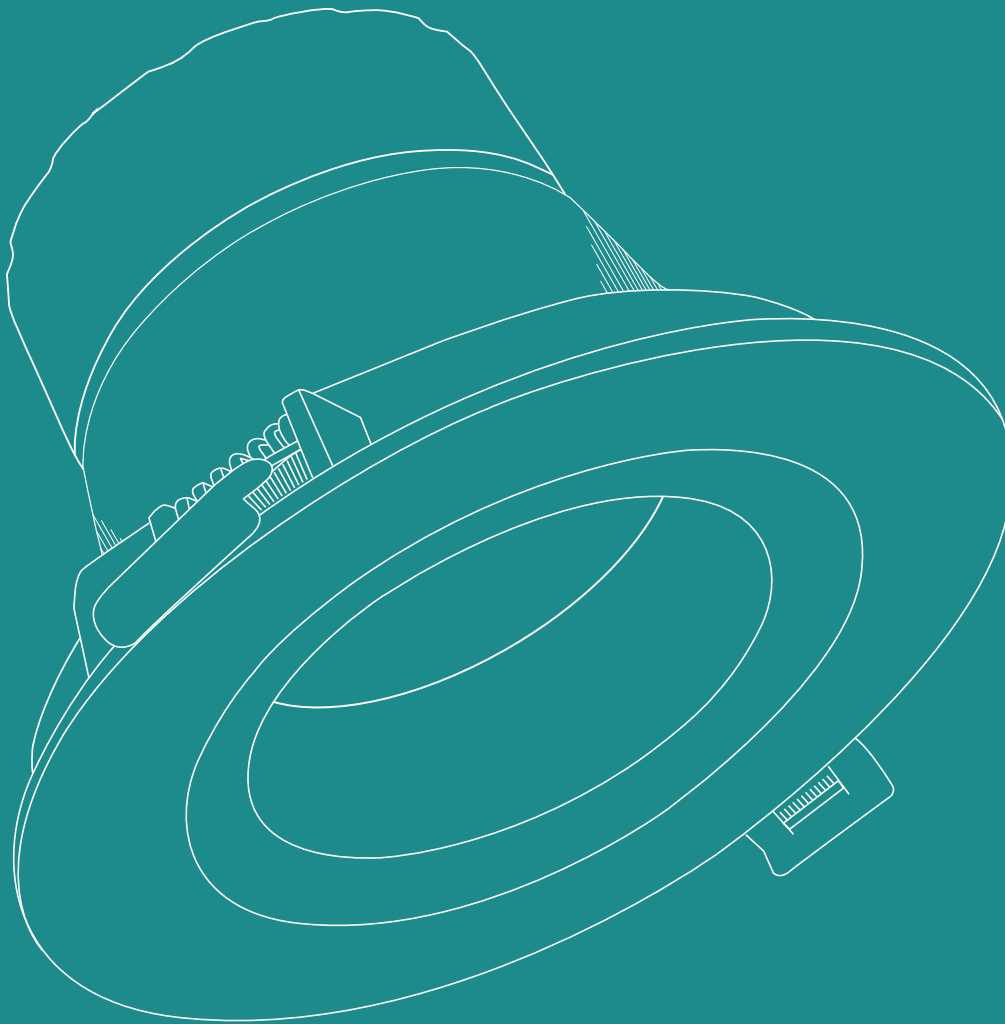

*Downlights are a popular lighting form, they are versatile, easy to fit and can be discreet. Downlights can illuminate a large area, focus a narrow beam or work indirectly by wall washing the side walls with light.*

*Glare could be a problem for a designer unless you are utilising Haneco superior high performing low glare reflectors and diffusers.*

*Unrivalled efficiency and higher output, the Haneco LED downlight range is very comprehensive and covers every conceivable need, allowing the Electrician a solution for any application.*

# DOWNLIGHT

## RESIDENTIAL DOWNLIGHT



VIVA p17



AURORA p21



STELLAR 60 p25



DULAR p26



DETAIL p26



DIONE p29

## COMMERCIAL DOWNLIGHT



CENTAURI p32



MARS p34



STELLAR p35



CEDAR SNORKEL  
p37

## SQUARE DOWNLIGHT



AURORA SQUARE  
p39



XBOX p40



CEDAR p41



RESIDENTIAL DOWNLIGHT



# VIVA Multi 90

## Tritone Flush Diffuser LED Downlight



### DESCRIPTION

All in one solution with our built in dimmable driver and selectable colour temperature. It features excellent performance and allows for easy installation. Tri-tone technology allows you to select colour temperatures and clip-on trims give you a choice of finishes.

### KEY FEATURES

- Selectable colour temperature - 3000K, 4200K and 5700K
- IP44 ingress protection from below
- IC-4 covered & abutted with insulation
- Complete with flex and plug for simple installation
- Optional clip-on trim finishes (Black and Nickel)

### APPLICATIONS

Residential, Offices, Retail

Standards



POWER	FEATURE	LUMEN	lm/W	CCT	WEIGHT	SAP CODE	PRODUCT CODE
7W	Tritone	550 lm	78 lm/W	3000K	0.23 kg	2000690	<b>VIVA90-MULTI</b>
		620 lm	89 lm/W	4200K			
		600 lm	86 lm/W	5700K			

ACCESSORIES	FEATURES	SAP CODE	PRODUCT CODE
Clip-on Trim	Nickel	2000894	<b>TRN-VIVA90</b>
Clip-on Trim	Black	2001058	<b>TRB-VIVA90</b>

Dimensions

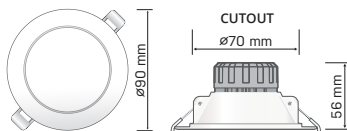

Accessories



VIVA MULTI 90

# VIVA 115

## Tritone Flush Diffuser LED Downlight



### DESCRIPTION

All in one solution with our built in dimmable driver and selectable colour temperature. It features excellent performance and allows for easy installation. Tri-tone technology allows you to select colour temperatures and clip-on trims give you a choice of finishes.

### KEY FEATURES

- Selectable colour temperature - 3000K, 4200K and 5700K
- IP44 ingress protection from below
- IC-4 covered & abutted with insulation
- Complete with flex and plug for simple installation
- Optional clip-on trim finishes (Black, nickel and gold)

### APPLICATIONS

Residential, Offices, Retail

Standards



POWER	FEATURE	LUMEN	lm/W	CCT	WEIGHT	SAP CODE	PRODUCT CODE
8W	Tritone	800 lm	100 lm/W	3000K	0.20 kg	2001847	<b>VIVA-FL-TRI</b>
		850 lm	106 lm/W	4200K			
		800 lm	100 lm/W	5700K			

ACCESSORIES	FEATURES	SAP CODE	PRODUCT CODE
Adaptor Ring	130mm	2001878	<b>TRIM-VIVA-130</b>
	170mm	2001877	<b>TRIM-VIVA-170</b>
Clip-on Trim	Nickel	2001876	<b>TRIM-VIVA-NKL</b>
	Black	2001875	<b>TRIM-VIVA-GLD</b>
	Gold	2001874	<b>TRIM-VIVA-BLK</b>

Dimensions

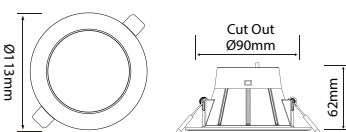

ADAPTOR RING 170mm

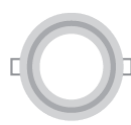

ADAPTOR RING 130mm



CLIP-ON TRIM Black



CLIP-ON TRIM Gold



CLIP-ON TRIM Nickel

Accessories



# VIVA 115

## Tritone Recessed Diffuser LED Downlight

DOWNLIGHT



### DESCRIPTION

All in one solution with our built in dimmable driver and selectable colour temperature. It features excellent performance and allows for easy installation. Tri-tone technology allows you to select colour temperatures and the recessed diffuser designed to reduced glare.

### KEY FEATURES

- Selectable colour temperature - 3000K, 4200K and 5700K
- IP44 ingress protection from below
- IC-4 covered & abutted with insulation
- Complete with flex and plug for simple installation

### APPLICATIONS

Residential, Offices, Retail

Standards



POWER	FEATURE	LUMEN	lm/W	CCT	WEIGHT	SAP CODE	PRODUCT CODE
8W	Tritone	800 lm	100 lm/W	3000K	0.20 kg	2001846	<b>VIVA-RC-TRI</b>
		850 lm	106 lm/W	4200K			
		800 lm	100 lm/W	5700K			

ACCESSORIES	FEATURES	SAP CODE	PRODUCT CODE
Adaptor Ring	130mm	2001878	<b>TRIM-VIVA-130</b>
	170mm	2001877	<b>TRIM-VIVA-170</b>

Dimensions

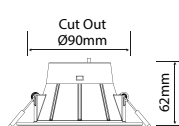
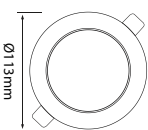

Accessories



# VIVA 145

## Tritone Flush Diffuser LED Downlight



### DESCRIPTION

All in one solution with our built in dimmable driver and selectable colour temperature. The VIVA 145 is ideal for large existing cutout without the need of an adaptor plate. Tri-tone technology allows you to select colour temperatures.

### KEY FEATURES

- Selectable colour temperature - 3000K, 4200K and 5700K
- IP44 ingress protection
- Complete with flex and plug for simple installation
- 125mm cutout, ideal for existing large cutout

### APPLICATIONS

Residential, Office

Standards



POWER	FEATURE	LUMEN	lm/W	CCT	WEIGHT	SAP CODE	PRODUCT CODE
14W	Tritone	1240 lm	89 lm/W	3000K	0.29 kg	2001103	<b>VIVA145-TRI</b>
		1260 lm	90 lm/W	4200K			
		1160 lm	83 lm/W	5700K			

Dimensions

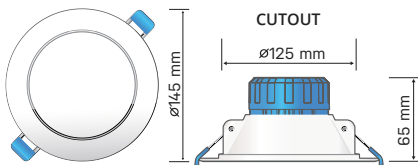

VIVA 145

# AURORA 80

## Flush Diffuser LED Downlight



### DESCRIPTION

AURORA 80 is a compact, low glare downlight with optional clip-on trims give you a choice of finishes. IC-4 rating makes it safe with insulation.

### KEY FEATURES

- Available in 3000K or 5000K
- IP44 ingress protection
- Complete with flex and plug for simple installation
- Complete with remote dimmable driver

### APPLICATIONS

Residential, Office, Retail, Galleries

Standards



POWER	LUMEN	lm/W	CCT	WEIGHT	SAP CODE	PRODUCT CODE
7W	540 lm	77 lm/W	3000K	0.39 kg	2000046	<b>AURORA80A01</b>
7W	600 lm	86 lm/W	5000K	0.39 kg	2000047	<b>AURORA80A02</b>

Dimensions

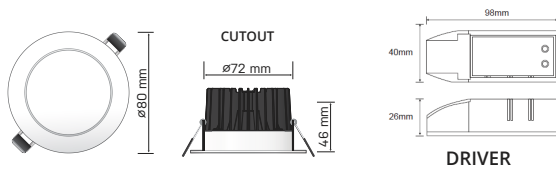

AURORA 80

# AURORA Tritone

## Tritone Recessed Diffuser Low Profile LED Downlight



### DESCRIPTION

All in one solution with our remote dimmable driver and selectable colour temperature. It features excellent performance and allows for easy installation. Tri-tone technology allows you to select colour temperatures with white, black or nickel finishes.

### KEY FEATURES

- Selectable colour temperature - 3000K, 4200K and 5700K
- IP44 ingress protection
- 42mm slim profile, ideal for narrow ceiling space
- Diecast aluminium construction
- Complete with flex and plug for simple installation
- Complete with remote dimmable driver
- Available in white, black or nickel finishes

### APPLICATIONS

Residential, Offices, Retail

### Dimensions

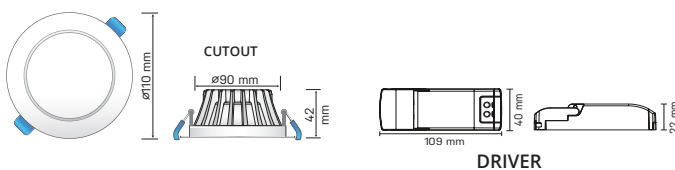

**Standards**



POWER	FEATURE	LUMEN	lm/W	CCT	WEIGHT	SAP CODE	PRODUCT CODE
9W	White trim	760 lm	84 lm/W	3000K	0.20 kg	2000850	<b>AURORA9W110-W-TRI</b>
		860 lm	96 lm/W	4200K			
		760 lm	84 lm/W	5700K			
9W	Nickel trim	760 lm	84 lm/W	3000K	0.20 kg	2001078	<b>AURORA9W110-N-TRI</b>
		860 lm	96 lm/W	4200K			
		760 lm	84 lm/W	5700K			
9W	Black trim	760 lm	84 lm/W	3000K	0.20 kg	2001077	<b>AURORA9W110-B-TRI</b>
		860 lm	96 lm/W	4200K			
		760 lm	84 lm/W	5700K			
12W	White trim	1020 lm	85 lm/W	3000K	0.20 kg	2000849	<b>AURORA12W110-W-TRI</b>
		1170 lm	98 lm/W	4200K			
		1050 lm	88 lm/W	5700K			
12W	Nickel trim	1020 lm	85 lm/W	3000K	0.20 kg	2001080	<b>AURORA12W110-N-TRI</b>
		1170 lm	98 lm/W	4200K			
		1050 lm	88 lm/W	5700K			
12W	Black trim	1020 lm	85 lm/W	3000K	0.20 kg	2001079	<b>AURORA12W110-B-TRI</b>
		1170 lm	98 lm/W	4200K			
		1050 lm	88 lm/W	5700K			

ACCESSORIES	FEATURES	SAP CODE	PRODUCT CODE
Adaptor ring	130mm	2000455	<b>TRIM-AURORAV2-130-W</b>
	170mm	2000456	<b>TRIM-AURORAV2-170-W</b>

**Accessories**

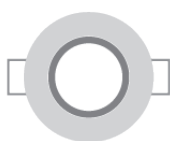

ADAPTOR RING  
170MM

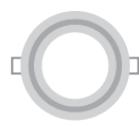

ADAPTOR RING  
130mm



NICKLE TRIM



WHITE TRIM



BLACK TRIM





# STELLAR 60

## Adjustable Narrow Beam LED Downlight



### DESCRIPTION

The STELLAR 60 is a small adjustable downlight with white trim for accent lighting.

### KEY FEATURES

- Available in 3000K, 4000K or 6000K
- IP40 ingress protection
- Small profile, ideal for cabinet lighting
- Complete with remote driver

### APPLICATIONS

Retail, Galleries

Standards



POWER	LUMEN	lm/W	CCT	WEIGHT	SAP CODE	PRODUCT CODE
3W	250 lm	83 lm/W	3000K	0.25 kg	2000440	<b>STELLAR60A01</b>
3W	220 lm	73 lm/W	4000K	0.25 kg	2000442	<b>STELLAR60A4K</b>
3W	210 lm	70 lm/W	6000K	0.25 kg	2000441	<b>STELLAR60A02</b>

Dimensions

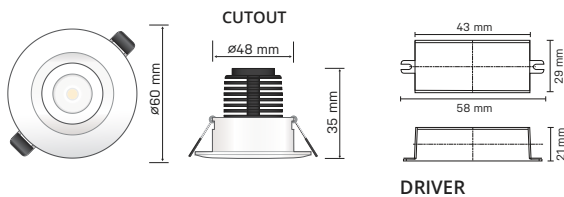

# DULAR COMING SOON...

## Fixed LED Downlight



### DESCRIPTION

All in one solution with our built in dimmable driver and selectable colour temperature. The trimless downlight with recessed design features low glare and soft output. Tri-tone technology allows you to select colour temperatures.

### KEY FEATURES

- Selectable colour temperature - 3000K, 4000K and 5700K
- IP44 ingress protection
- Low glare design
- IC loosely covered with building insulation
- Complete with flex and plug for simple installation

### APPLICATIONS

Residential, Offices, Retail

Standards



POWER	FEATURE	LUMEN	lm/W	CCT	WEIGHT	SAP CODE	PRODUCT CODE
9W	Tritone	930 lm	103 lm/W	3000K	0.25 kg	2001850	<b>DULAR-FIX-TRI</b>
		950 lm	108 lm/W	4000K			
		900 lm	100 lm/W	5700K			

Dimensions

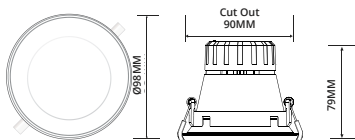

DULAR-FIX-TRI



DULAR FIXED



# DULAR COMING SOON...

## Adjustable LED Downlight



### DESCRIPTION

All in one solution with our built in dimmable driver and selectable colour temperature. The adjustable downlight with recessed design features low glare and soft output. Tri-tone technology allows you to select colour temperatures.

### KEY FEATURES

- Selectable colour temperature - 3000K, 4000K and 5700K
- Low glare design
- IC loosely covered with building insulation
- Complete with flex and plug for simple installation

### APPLICATIONS

Residential, Offices, Retail

Standards



POWER	FEATURE	LUMEN	lm/W	CCT	WEIGHT	SAP CODE	PRODUCT CODE
9W	Tritone	940 lm	105 lm/W	3000K	0.25 kg	2001856	<b>DULAR-ADJ-TRI</b>
		980 lm	109 lm/W	4000K			
		920 lm	102 lm/W	5700K			

Dimensions

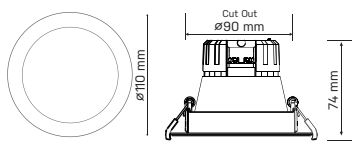

DULAR-ADJ-TRI



DULAR ADJUSTABLE

# DETAIL

## Adjustable Narrow Beam LED Downlight



### DESCRIPTION

An adjustable remote driver downlight with highly engineered optical lens to reduce glare. This IP65 adjustable downlight is ideal for bathrooms and outdoor applications.

### KEY FEATURES

- Available in 3000K, 4000K or 5000K
- IP65 ingress protection
- Diecast aluminium construction
- Low glare design
- IC-4 covered & abutted with insulation
- Complete with flex and plug for simple installation
- Complete with remote driver

### APPLICATIONS

Residential, Offices, Retail

Standards



POWER	FEATURE	LUMEN	lm/W	CCT	WEIGHT	SAP CODE	PRODUCT CODE
9W	White Adjustable	890 lm	99 lm/W	3000K	0.40 kg	2000159	<b>D9W110R3KWIP65</b>
9W	Black Adjustable	890 lm	99 lm/W	3000K	0.40 kg	2000584	<b>D9W110R3KBKIP65</b>
9W	White Adjustable	940 lm	104 lm/W	4000K	0.40 kg	2000161	<b>D9W110R4KWIP65</b>
9W	Black Adjustable	940 lm	104 lm/W	4000K	0.40 kg	2000160	<b>D9W110R4KBKIP65</b>
9W	White Adjustable	980 lm	109 lm/W	5000K	0.40 kg	2000164	<b>D9W110R5KWIP65</b>
9W	Black Adjustable	980 lm	109 lm/W	5000K	0.40 kg	2000585	<b>D9W110R5KBKIP65</b>

Dimensions

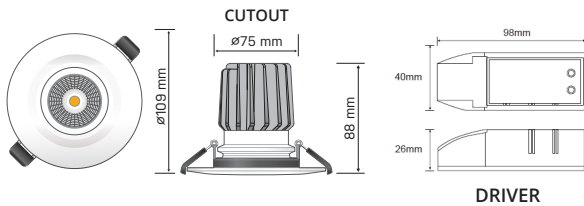

**BLACK ADJUSTABLE WHITE ADJUSTABLE**

# DIONE

## Adjustable Narrow Beam LED Downlight



### DESCRIPTION

A high output adjustable downlight with highly engineered optical control to reduce glare. This adjustable downlight is ideal for commercial and retail applications.

### KEY FEATURES

- IP54 ingress protection
- Low glare design
- Complete with flex and plug for simple installation
- Complete with remote driver

### APPLICATIONS

Residential, Offices, Retail, Galleries

standards

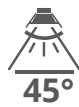

POWER	FEATURE	LUMEN	lm/W	CCT	WEIGHT	SAP CODE	PRODUCT CODE
15W	White Adjustable	1100 lm	73 lm/W	3000K	0.90 kg	2000145	<b>D15W109R3KW</b>
15W	Silver Adjustable	1100 lm	73 lm/W	3000K	0.90 kg	2000144	<b>D15W109R3KS</b>

Dimensions

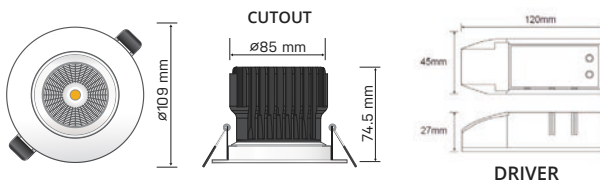

COMMERCIAL DOWNLIGHT







# CENTAURI

## Dual Intensity Tritone LED Shoplight



### DESCRIPTION

A versatile commercial downlight with selectable output and colour temperatures with the flick of a switch. It's low profile makes this an ideal choice where ceiling space is limited.

### KEY FEATURES

- Selectable output from 10W to 30W
- Selectable colour temperature - 3000K, 4000K and 5000K
- Diecast aluminium construction
- IP44 ingress protection
- IC-4 covered & abutted with insulation
- Complete with remote control gear
- Complete with flex and plug for simple installation

### APPLICATIONS

Offices, Retail, Galleries

### Dimensions

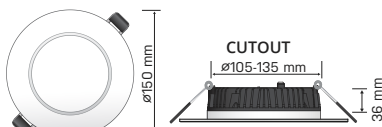

C10/15W150R-MULTI

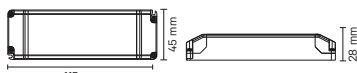

10W / 15W DRIVER

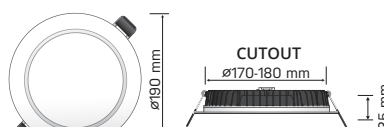

C15/25W190R-MULTI

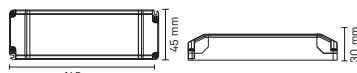

15W / 25W DRIVER

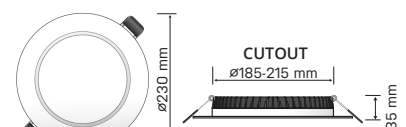

C20/30W230R-MULTI

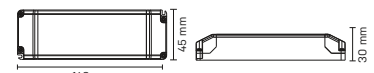

20W / 30W DRIVER

Standards



POWER	FEATURE	LUMEN	lm/W	CCT	WEIGHT	SAP CODE	PRODUCT CODE
10W	Selectable output Tritone	1010 lm	101 lm/W	3000K	0.75 kg	2001195	<b>C10/15W150R-MULTI</b>
		1090 lm	109 lm/W	4000K			
		1090 lm	109 lm/W	5000K			
1440 lm		96 lm/W	3000K				
15W		1520 lm	101 lm/W	4000K			
		1490 lm	99 lm/W	5000K			
15W	Selectable output Tritone	1470 lm	98 lm/W	3000K	0.96 kg	2001087	<b>C15/25W190R-MULTI</b>
		1600 lm	107 lm/W	4000K			
		1610 lm	107 lm/W	5000K			
25W		2500 lm	100 lm/W	3000K			
		2680 lm	107 lm/W	4000K			
25W		2640 lm	106 lm/W	5000K			
	20W	2090 lm	105 lm/W	3000K	1.20 kg	2000576	<b>C20/30W230R-MULTI</b>
		20W	2250 lm	113 lm/W			
2220 lm			111 lm/W	5000K			
30W	3040 lm		101 lm/W	3000K			
	3130 lm	104 lm/W	4000K				
30W	3050 lm	102 lm/W	5000K				

ACCESSORIES	FEATURES	SAP CODE	PRODUCT CODE
Adaptor ring	280mm	2001219	TRIM-C2030-280-W*

\*Suits 20W / 30W only.

Accessories



ADAPTOR RING  
280mm



CENTAURI  
10W/ 15W

CENTAURI  
15W/ 25W

CENTAURI  
20W/ 30W

# MARS

## Faceted Reflector LED Shoplight



### DESCRIPTION

The MARS range is an energy efficient alternative to metal halide downlights with high output. It comes with multifaceted reflector for glare control and aesthetically pleasing design which is ideal for retail applications.

### KEY FEATURES

- IP40 ingress protection
- Complete with remote control gear
- Complete with flex and plug for simple installation

### APPLICATIONS

Retail, Galleries

Standards



POWER	LUMEN	lm/W	CCT	WEIGHT	SAP CODE	PRODUCT CODE
20W	1420 lm	71 lm/W	4000K	1.00 kg	2000336	<b>MARS20W160R4K</b>
30W	2520 lm	84 lm/W	4000K	1.20 kg	2000338	<b>MARS30W190R4K</b>
40W	3470 lm	87 lm/W	4000K	1.32 kg	2000340	<b>MARS40W215R4K</b>

Dimensions

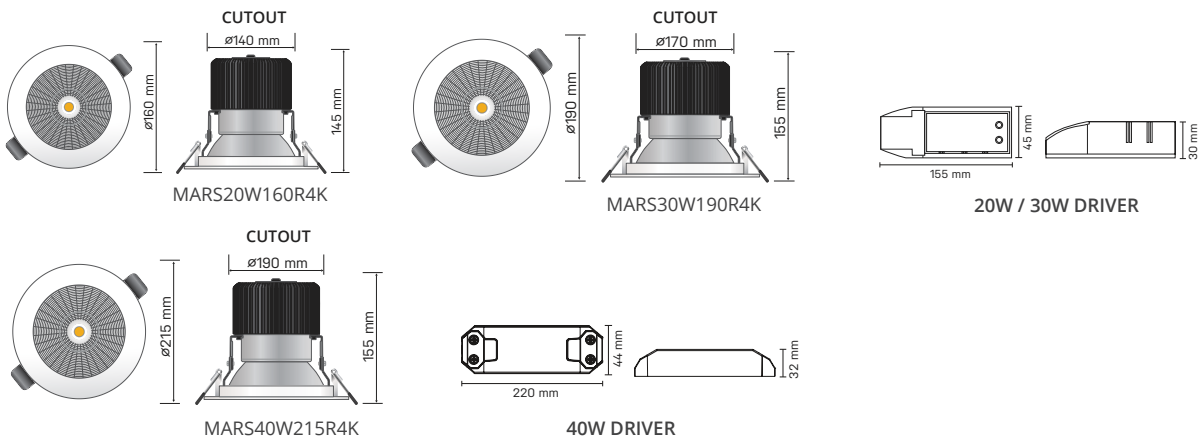

MARS



# STELLAR

## Faceted Reflector Gimbal LED Downlight



### DESCRIPTION

The STELLAR range is an energy efficient alternative to metal halide adjustable downlights with high output. It comes with multifaceted reflector for glare control and aesthetically pleasing design which is ideal for retail applications.

### KEY FEATURES

- IP40 ingress protection
- Complete with remote control gear
- Complete with flex and plug for simple installation

### APPLICATIONS

Retail, Galleries

### Standards



POWER	FEATURE	LUMEN	lm/W	CCT	WEIGHT	SAP CODE	PRODUCT CODE
15W	Adjustable	1230 lm	82 lm/W	4000K	1.00 kg	2000434	<b>STELLAR120A4K</b>
20W	Adjustable	1970 lm	99 lm/W	4000K	1.00 kg	2000436	<b>STELLAR145A4K</b>
30W	Adjustable	2860 lm	95 lm/W	4000K	1.20 kg	2000438	<b>STELLAR170A4K</b>
40W	Adjustable	3450 lm	86 lm/W	4000K	1.40 kg	2000439	<b>STELLAR190A4K</b>

### Dimensions

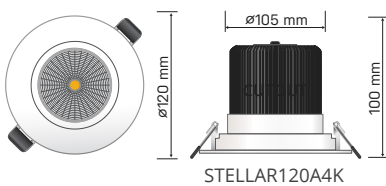

STELLAR120A4K

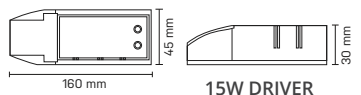

15W DRIVER

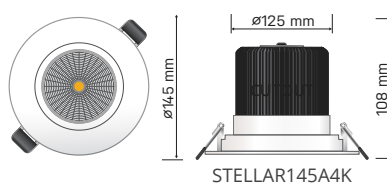

STELLAR145A4K

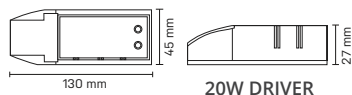

20W DRIVER

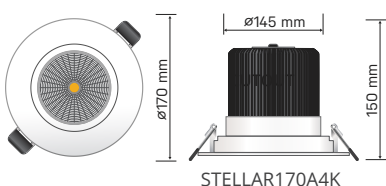

STELLAR170A4K

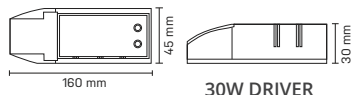

30W DRIVER

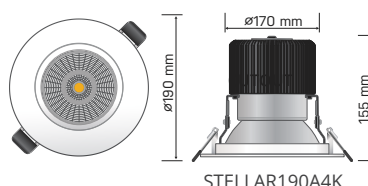

STELLAR190A4K

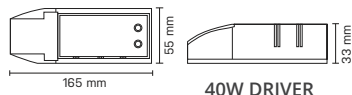

40W DRIVER



STELLAR



# CEDAR SNORKEL

## Gimbal LED Shoplight



### DESCRIPTION

CEDAR SNORKEL is an ideal LED shoplight with multifaceted reflector for glare control. It is an ideal alternative to metal halide shoplights for retail applications.

### KEY FEATURES

- IP40 ingress protection
- 0-90° Adjustable angle
- Complete with remote control gear
- Complete with flex and plug for simple installation

### APPLICATIONS

Retail, Galleries

Standards



POWER	FEATURE	LUMEN	lm/W	CCT	WEIGHT	SAP CODE	PRODUCT CODE
38W	Adjustable	3050 lm	80 lm/W	4000K	1.50 kg	2000151	<b>D38W195R4K60DF</b>

Dimensions

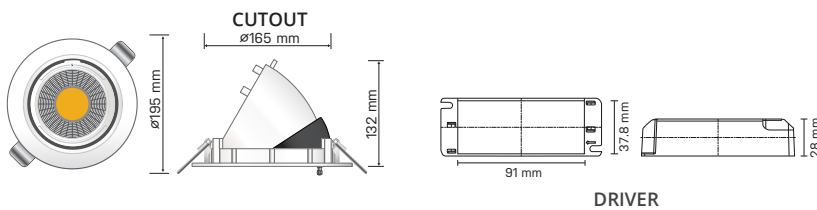

CEDAR



SQUARE DOWNLIGHT





# AURORA SQUARE

## Square Recessed Diffuser LED Shoplight



### DESCRIPTION

A square commercial downlight with low glare design to provide comfortable lighting. This stylish downlight is ideal for any residential or retail applications.

### KEY FEATURES

- Diecast aluminium construction
- Low glare design
- Complete with remote control gear
- Complete with flex and plug for simple installation

### APPLICATIONS

Offices, Retail, Galleries

Standards

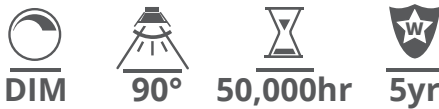

POWER	LUMEN	lm/W	CCT	WEIGHT	SAP CODE	PRODUCT CODE
13W	830 lm	64 lm/W	3000K	0.70 kg	2000053	<b>AURORASQ115A01<sup>1</sup></b>
13W	910 lm	70 lm/W	5000K	0.70 kg	2000054	<b>AURORASQ115A02<sup>1</sup></b>
18W	1380 lm	77 lm/W	5000K	0.70 kg	2000056	<b>AURORASQ150A02<sup>1</sup></b>
26W	2010 lm	77 lm/W	4000K	1.30 kg	2000058	<b>AURORASQ190A4K<sup>2</sup></b>
26W	2070 lm	80 lm/W	5000K	1.30 kg	2000057	<b>AURORASQ190A02<sup>2</sup></b>
28W	2460 lm	88 lm/W	3000K	1.40 kg	2000059	<b>AURORASQ220A01<sup>2</sup></b>
28W	2460 lm	88 lm/W	4000K	1.40 kg	2000061	<b>AURORASQ220A4K<sup>2</sup></b>
28W	2460 lm	88 lm/W	5000K	1.40 kg	2000060	<b>AURORASQ220A02<sup>2</sup></b>

<sup>1</sup>IP54 <sup>2</sup>IP40

Dimensions

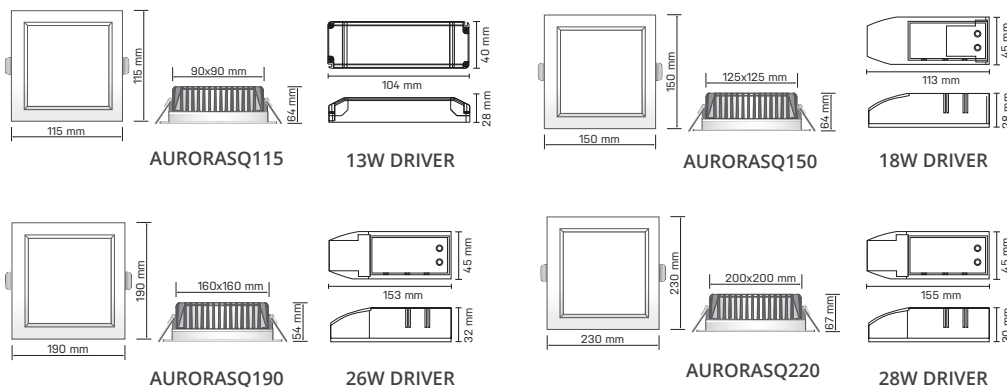

# XBOX

## Square Adjustable Narrow Beam LED Downlight



### DESCRIPTION

A stylish square adjustable downlight with single, twin or triple LED modules. The XBOX is ideal for retail applications.

### KEY FEATURES

- Powder coated aluminium trim
- Low glare design
- Complete with remote control gear
- Complete with flex and plug for simple installation

### APPLICATIONS

Retail, Galleries

### Standards



POWER	FEATURE	LUMEN	lm/W	CCT	WEIGHT	SAP CODE	PRODUCT CODE
10W	Single head	820 lm	82 lm/W	3000K	0.60 kg	2000520	<b>D10W112*112RE3KW</b>
15W		1170 lm	78 lm/W	3000K	0.98 kg	2000522	<b>D15W176*176RE3KW</b>
20W	Twin head	1730 lm	87 lm/W	3000K	1.10 kg	2000527	<b>D20W200*112RE3KW</b>
30W		2390 lm	80 lm/W	3000K	2.05 kg	2000531	<b>D30W320*176RE3KW</b>
30W	Triple head	2230 lm	74 lm/W	3000K	1.28 kg	2000529	<b>D30W280*112RE3KW</b>

### Dimensions

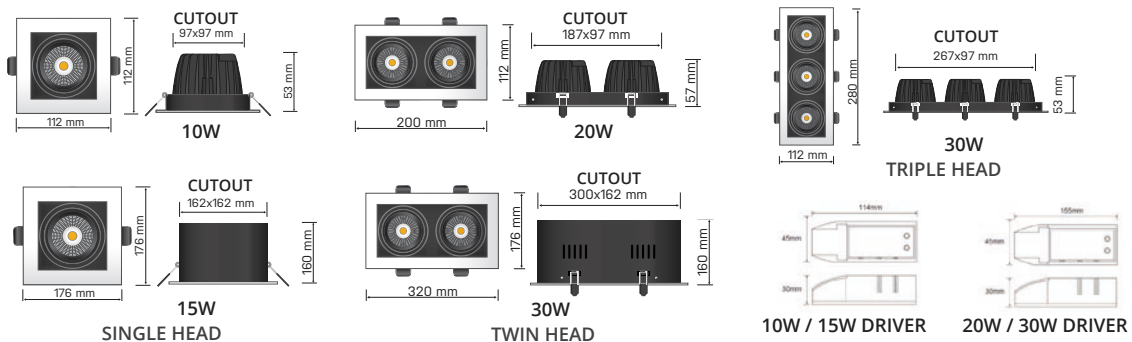

# CEDAR

## Adjustable LED Shoplight



### DESCRIPTION

CEDAR is a square LED shoplight with even light distribution. It is an ideal alternative to metal halide shoplights for retail applications.

### KEY FEATURES

- Ideal alternative to metal halide shoplights
- Complete with remote control gear
- Complete with flex and plug for simple installation

### APPLICATIONS

Retail, Galleries

### Standards



POWER	LUMEN	lm/W	CCT	WEIGHT	SAP CODE	PRODUCT CODE
40W	4160 lm	104 lm/W	4000K	1.50 kg	2000534	<b>D40W242*150RE4K90DF*</b>
40W	4100 lm	103 lm/W	5000K	1.50 kg	2000536	<b>D40W242*150RE5K90DF</b>

*\*VEU / IPART Approved*

### Dimensions

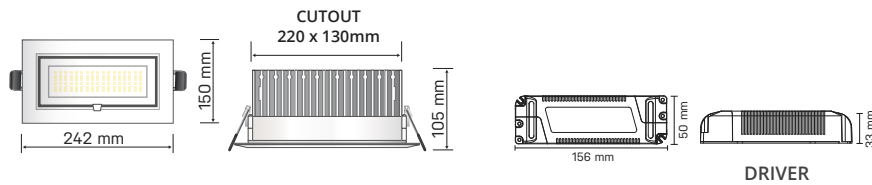





### West Franklin Apartments, Adelaide

Rising skywards out of the humble bricks and mortar of the old Balfours site, West Franklin is the first in a series of mesmerising towers planned for an urban village already garnering a reputation as one of the city's hippest.

Located on the corner of Franklin and Elizabeth Street in Adelaide, the project delivered a residential development incorporating two apartment towers up to 22 stories, 268 apartments including 47 different apartment designs, communal facilities, podium garden and multilevelled car park.

**Featured Products: VIVA, TRIPROOF, METEOR**



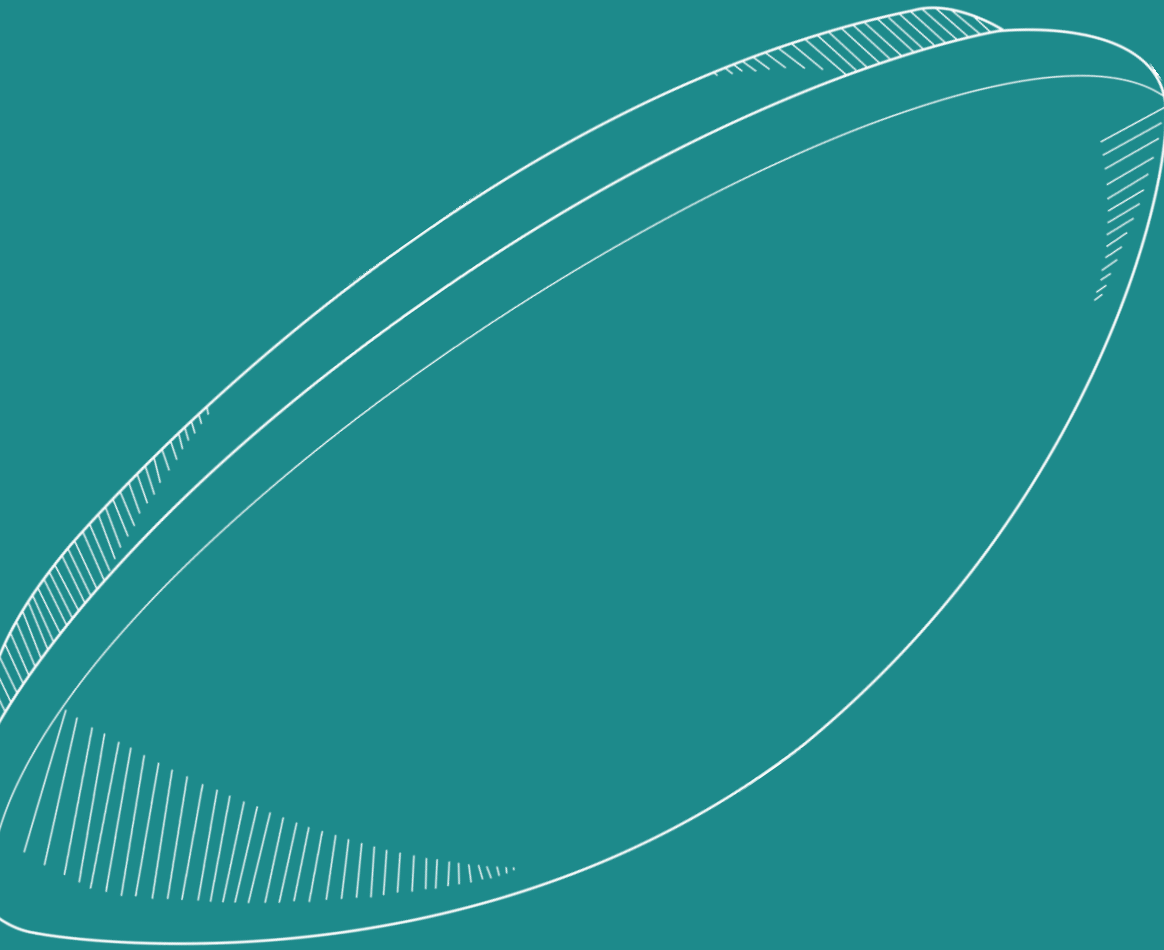

*Surface mounted light fittings are another alternative to recessed or gimble downlights and are mounted on the surface of the ceiling.*

*These type of light fixtures are popular in residential and commercial applications and are simple to install.*

*At Haneco we understand that care needs to be taken with respect thermal control to achieve maximum energy efficacy.*

*Ideal for application where there is limited space in the ceiling or concrete slab.*

# SURFACE MOUNT

## ■ DOWNLIGHT



METEOR p48

## ■ OYSTER



PURO 400 p52



PLUTO p54



PURO 350 p56



DISCUS p57



# DOWNLIGHT









# METEOR

## Surface Mount Reflector LED Downlight

SURFACE MOUNT



### DESCRIPTION

A surface mount downlight with multifaceted reflector for optimum glare control. The IP54 METEOR downlight is ideal for indoor and outdoor applications.

### KEY FEATURES

- Powder coated steel construction
- Available in white or black

### APPLICATIONS

Offices, Retail, Galleries

### Dimensions

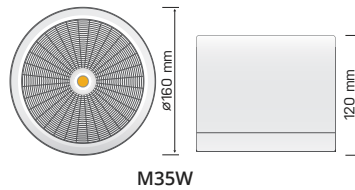
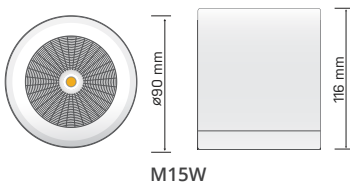

Standards

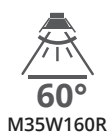
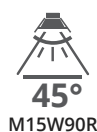

POWER	FEATURE	LUMEN	lm/W	CCT	WEIGHT	SAP CODE	PRODUCT CODE
15W	White	1170 lm	78 lm/W	3000K	0.40 kg	2000329	<b>M15W90R3K45DC</b>
15W	Black	1170 lm	78 lm/W	3000K	0.40 kg	2000330	<b>M15W90R3K45DC-B</b>
15W	White	1190 lm	79 lm/W	4000K	0.40 kg	2000332	<b>M15W90R4K45DC-W</b>
15W	Black	1190 lm	79 lm/W	4000K	0.40 kg	2000331	<b>M15W90R4K45DC-B</b>
15W	White	1190 lm	79lm/W	3000K	1.20 kg	2001661	<b>M15W160R3K60DC</b>
35W	White	2880 lm	82 lm/W	3000K	1.20 kg	2000729	<b>M35W160R3K60DC</b>
35W	Black	2880 lm	82 lm/W	3000K	1.20 kg	2000647	<b>M35W160R3K60DC-B</b>
35W	White	3030 lm	87 lm/W	4000K	1.20 kg	2000333	<b>M35W160R4K60DC</b>
35W	Black	3020 lm	86 lm/W	4000K	1.20 kg	2000334	<b>M35W160R4K60DC-B</b>



15W

OYSTER







# PURO 300/400

## Tritone LED Oyster

SURFACE MOUNT



### DESCRIPTION

The PURO is an ideal oyster light for residential applications. The opal acrylic diffuser provides even light distribution to the space and large terminal block for easy installation.

### KEY FEATURES

- Selectable colour temperature - 3000K, 4200K and 5700K
- Opal acrylic diffuser
- Optional dimmable driver

### APPLICATIONS

Residential

### Dimensions

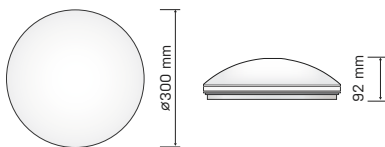

PURO 300 Multi

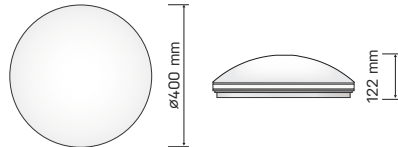

PURO 400 Multi



standards



POWER	FEATURE	LUMEN	lm/W	CCT	WEIGHT	SAP CODE	PRODUCT CODE
15W	Tritone	1100 lm	73 lm/W	3000K	0.66 kg	2000103	<b>CL15W300R-MULTI</b>
		1200 lm	80 lm/W	4200K			
		1200 lm	80 lm/W	5000K			
25W	Tritone	1690 lm	68 lm/W	3000K	0.80 kg	2000112	<b>CL25W400R-MULTI</b>
		1840 lm	74 lm/W	4200K			
		1800 lm	72 lm/W	5700K			
25W	Tritone Intellisensor	1690 lm	68 lm/W	3000K	0.80 kg	2000111	<b>CL25W400R-MUL-SS</b>
		1840 lm	74 lm/W	4200K			
		1800 lm	72 lm/W	5700K			

EMERGENCY SPECIFICATION

FEATURE	LUMEN	lm/W	CCT	EMERGENCY CLASSIFICATION	BATTERY TYPE	WEIGHT	SAP CODE	PRODUCT CODE
Tritone Emergency	1690 lm	68 lm/W	3000K	C0=D32, C90=D32	LiFePO4	1.20 kg	2000113	<b>CL25W400R-MULTI-EM</b>
	1840 lm	74 lm/W	4200K					
	1800 lm	72 lm/W	5700K					
Tritone Intellisensor Emergency	1690 lm	68 lm/W	3000K	C0=D32, C90=D32	LiFePO4	1.20 kg	2000110	<b>CL25W400R-MUL-EM-SS</b>
	1840 lm	74 lm/W	4200K					
	1800 lm	72 lm/W	5700K					

Dimmable LED Driver Replacement available, see **p194** for options.

# PLUTO

## Weatherproof Tritone LED Oyster

SURFACE MOUNT



### DESCRIPTION

The PLUTO is an ideal oyster light that is ideal for residential and commercial applications. The opal acrylic diffuser provides even light distribution to the space and large terminal block for easy installation.

### KEY FEATURES

- Selectable colour temperature - 3000K, 4200K and 5700K
- Opal acrylic diffuser
- IP54 insect resistant design
- Intellisensor with corridor function available
- Optional dimmable driver and emergency version available

### APPLICATIONS

Residential, Schools, Offices, Stairwells

### Dimensions

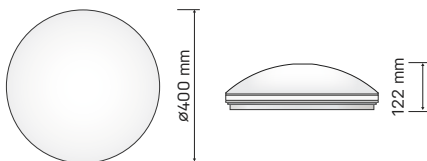

standards



POWER	FEATURE	LUMEN	lm/W	CCT	WEIGHT	SAP CODE	PRODUCT CODE
25W	Tritone	1690 lm	68 lm/W	3000K	1.10 kg	2000116	<b>CL25W400WP-MUL</b>
		1840 lm	74 lm/W	4200K			
		1800 lm	72 lm/W	5700K			
25W	Tritone Intellisensor	1690 lm	68 lm/W	3000K	1.10 kg	2000119	<b>CL25W400WP-MUL-SS</b>
		1840 lm	74 lm/W	4200K			
		1800 lm	72 lm/W	5700K			

EMERGENCY SPECIFICATION

POWER	FEATURE	LUMEN	lm/W	CCT	EMERGENCY CLASSIFICATION	BATTERY TYPE	WEIGHT	SAP CODE	PRODUCT CODE
25W	Tritone Emergency	1690 lm	68 lm/W	3000K	C0=D32, C90=D32	LiFePO4	1.50 kg	2000117	<b>CL25W-400WP-MUL-EM</b>
		1840 lm	74 lm/W	4200K					
		1800 lm	72 lm/W	5700K					
25W	Tritone Intellisensor Emergency	1690 lm	68 lm/W	3000K	C0=D32, C90=D32	LiFePO4	1.50 kg	2000118	<b>CL25W400WP-MUL-EM-SS</b>
		1840 lm	74 lm/W	4200K					
		1800 lm	72 lm/W	5700K					

Dimmable LED Driver Replacement available, see **p194** for options.

# PURO 350

## Weatherproof with Polycarbonate Base LED Oyster



### DESCRIPTION

The PURO 350 is an ideal oyster light that is ideal for residential and commercial applications. The opal acrylic diffuser provides even light distribution to the space and large terminal block for easy installation.

### KEY FEATURES

- Available in 4000K or 5000K
- Polycarbonate base
- Opal acrylic diffuser
- IP54 insect resistant design
- Integral dimmable driver

### APPLICATIONS

Residential, Schools, Offices, Stairwells

### Standards



POWER	LUMEN	lm/W	CCT	WEIGHT	SAP CODE	PRODUCT CODE
21W	1380 lm	66 lm/W	4000K	1.22 kg	200107	<b>CL21W350R4K120DF</b>
21W	1420 lm	68 lm/W	5000K	1.22 kg	200108	<b>CL21W350R5K120DF</b>

### Dimensions

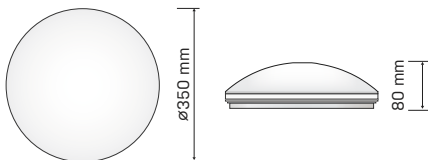

# DISCUS

## Indoor/Outdoor Low Profile Oyster



### DESCRIPTION

The DISCUS is an low profile oyster light that is ideal for residential and commercial applications.

### FEATURES

- 40mm low profile design
- IP54 insect resistant design
- Integral driver
- Aesthetically pleasing design

### APPLICATIONS

Residential, Schools, Offices, Stairwell

Standards



POWER	LUMEN	lm/W	CCT	WEIGHT	SAP CODE	PRODUCT CODE
32W	2730 lm	85 lm/W	3000K	0.46 kg	2000120	<b>CL32W300R3K120DF</b>

Dimensions

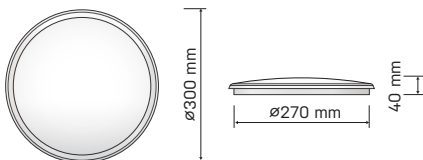





**Vietnamese Catholic Church, Adelaide SA**  
completed by Green Connect Australia, Adelaide SA

An 18 months refurbishment project using HANECO products gave this church an upgrade and reduced the total ownership cost of energy and maintenance.

Featured Products: AURORA, XBOX, FLEXION LED Strip, TRIPROOF Emergency





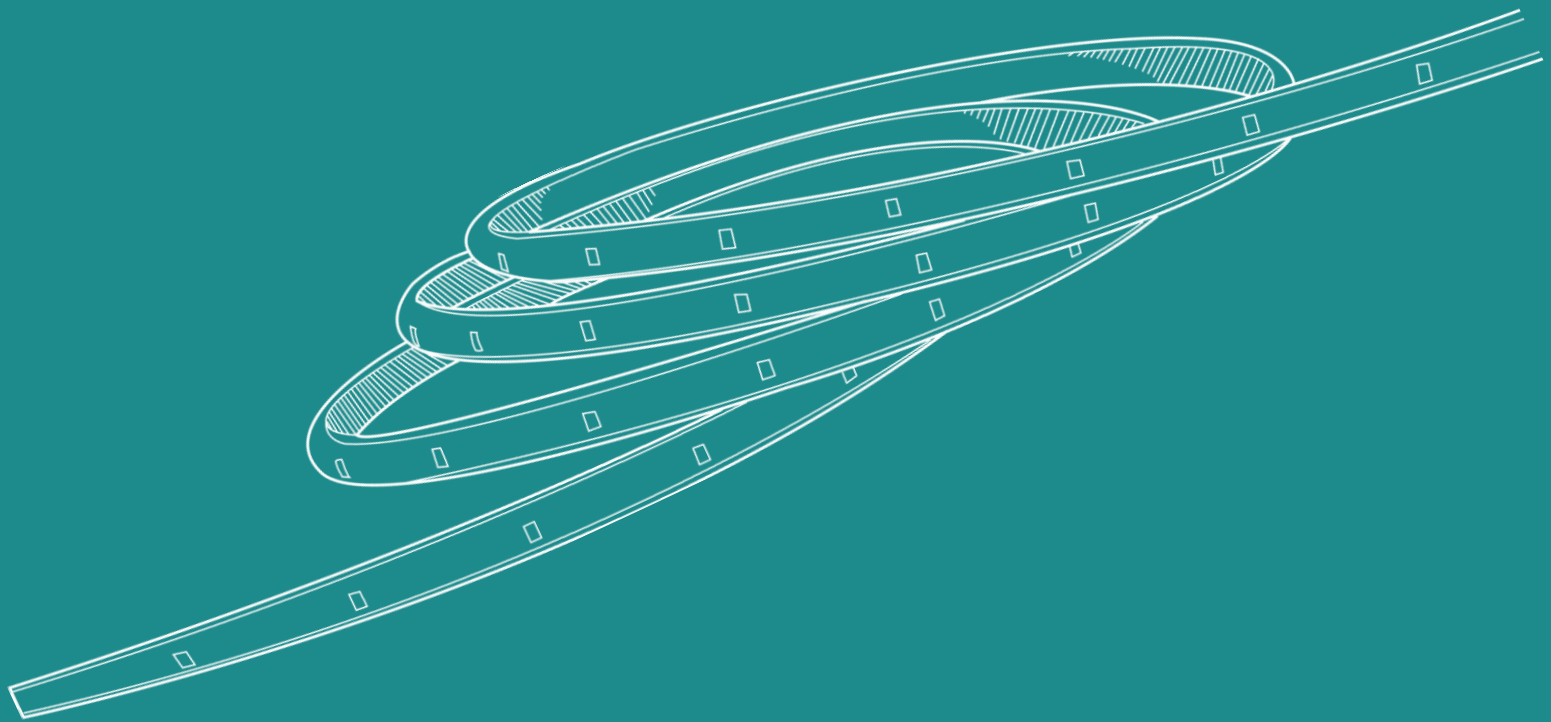

*The light colour, angle of incidence and spread of light on an object will have a radical effect on how an object is seen.*

*Something lit directly from overhead looks radically different to the same thing lit from below or at an angle. And when similarly, the same object is seen lit by different light sources (even of comparable outputs) it will appear with very different colour balances and even rendering of detail.*

*Hance's LED strip, profile and track range makes the electrician design task so much easier.*

# TRACKLIGHT & LED STRIP

## ■ TRACKLIGHT



FOCI 63

## ■ LED STRIP



FLEXION p68



PARALLAX p76

# TRACKLIGHT





# FOCI

## Adjustable LED Tracklight



### DESCRIPTION

Manufactured from diecast aluminium with an extruded aluminium driver box in horizontal position for superior thermal control.

### KEY FEATURES

- Track mounted adjustable spotlight
- 25W
- IP40
- Beam Angle 35°
- 350° rotate and 180° tilt

### APPLICATIONS

Residential, Offices, Retails, Galleries

Standards



POWER	LUMEN	lm/W	CCT	WEIGHT	SAP CODE	PRODUCT CODE
25W	2110 lm	84 lm/W	3000K	1.30 kg	2001335	<b>FOCI25W-B3KTRK</b>
25W	2170 lm	91 lm/W	3000K	1.30 kg	2001336	<b>FOCI25W-W3KTRK</b>
25W	2270 lm	84 lm/W	4000K	1.30 kg	2001337	<b>FOCI25W-B4KTRK</b>
25W	2270 lm	91 lm/W	4000K	1.30 kg	2001338	<b>FOCI25W-W4KTRK</b>

Dimensions

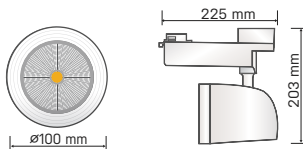

FOCI WHITE

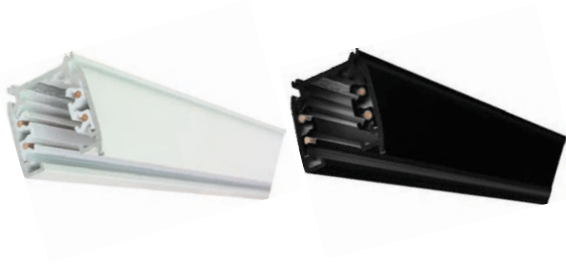

### 3 Circuit Track

Track available in 1m and 3m lengths, 240v, available in black and white

COLOUR	LENGTH	SAP CODE	PRODUCT CODE
White	1m	2000402	<b>SMFWT-WH-1M</b>
Black	1m	2000400	<b>SMFWT-BK-1M</b>
White	3m	2000403	<b>SMFWT-WH-3M</b>
Black	3m	2000401	<b>SMFWT-BK-3M</b>

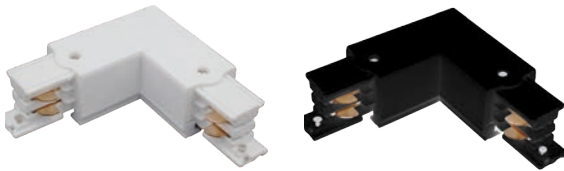

### 90° Simple Fit Bracket

Allows connection of track at 90 degrees

COLOUR	SAP CODE	PRODUCT CODE
White	2000417	<b>SMTCN-WH-90D</b>
Black	2000412	<b>SMTCN-BK-90D</b>



### 180° Simple Fit Bracket

Allows connection of track at 180 degrees

COLOUR	SAP CODE	PRODUCT CODE
White	2000416	<b>SMTCN-WH-180D</b>
Black	2000411	<b>SMTCN-BK-180D</b>



### 240V Initial Feed

Allows connection from power supply

COLOUR	SAP CODE	PRODUCT CODE
White	2000420	<b>SMTCN-WH-INTFEED</b>
Black	2000415	<b>SMTCN-BK-INTFEED</b>



### Simple Fit End Cap

Seals end of track

COLOUR	SAP CODE	PRODUCT CODE
White	2000418	<b>SMTCN-WH-ENDCAP</b>
Black	2000413	<b>SMTCN-BK-ENDCAP</b>



### 180° Flexible Track Bracket

Allows connection of track at 0-180 degrees

COLOUR	SAP CODE	PRODUCT CODE
White	2000419	<b>SMTCN-WH-FD</b>
Black	2000414	<b>SMTCN-BK-FD</b>



### Easy Adjust Suspension Kit

1.2m track suspension kit

COLOUR	SAP CODE	PRODUCT CODE
White	2000447	<b>SUSPENSION-KIT-WH</b>
Black	2000446	<b>SUSPENSION-KIT-BK</b>

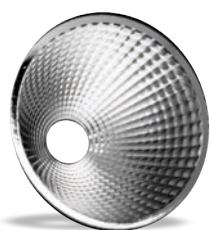

### Beam Adjustment Kit

Replacement reflectors for FOCI tracklight - beam angle 15° or 24°

BEAM ANGLE	SAP CODE	PRODUCT CODE
15°	2001380	<b>FOCI-RF15D</b>
24°	2001381	<b>FOCI-RF24D</b>

LED STRIP









# FLEXION LED STRIP

## 5M LED Strip Kit



### DESCRIPTION

FLEXION is our comprehensive range of LED strips that you can cut and easily mount in any place your imagination fancies.

### KEY FEATURES

- Flexible PCB and quality 3M double sided tape makes mounting on curved surfaces a breeze
- Available in warm white, neutral white and cool white
- Complete with driver and 1.2m flex and plug included for easy installation
- Optional dimmable drivers available - See page 72

### APPLICATIONS

Residential, Cafes, Restaurants, Lobbies, Bathrooms

### Standards



	FEATURES	POWER PER METER	LUMEN PER METER	lm/W	CCT	SAP CODE	PRODUCT CODE
High Intensity	IP20 24VDC	15 W/m	1555 lm/m	104 lm/W	3000K	2000223	<b>FS75W5MWW-IP20</b>
			1660 lm/m	111 lm/W	4000K	2000221	<b>FS75W5MNW-IP20</b>
			1564 lm/m	104 lm/W	6000K	2000219	<b>FS75W5MCW-IP20</b>
			1472 lm/m	98 lm/W	3000K	2000224	<b>FS75W5MWW-IP65</b>
			1395 lm/m	93 lm/W	4000K	2000222	<b>FS75W5MNW-IP65</b>
			1207 lm/m	80 lm/W	6000K	2000220	<b>FS75W5MCW-IP65</b>
Medium Intensity	IP20 24VDC	8 W/m	740 lm/m	93 lm/W	3000K	2000214	<b>FS40W5MWW-IP20</b>
			808 lm/m	101 lm/W	4000K	2000212	<b>FS40W5MNW-IP20</b>
			784 lm/m	98 lm/W	6000K	2000210	<b>FS40W5MCW-IP20</b>
			722 lm/m	90 lm/W	3000K	2000215	<b>FS40W5MWW-IP65</b>
			675 lm/m	84 lm/W	4000K	2000213	<b>FS40W5MNW-IP65</b>
			643 lm/m	80 lm/W	6000K	2000211	<b>FS40W5MCW-IP65</b>
Low Intensity	IP20 24VDC	5 W/m	382 lm/m	76 lm/W	3000K	2000203	<b>FS25W5MWW-IP20</b>
			410 lm/m	82 lm/W	4000K	2000201	<b>FS25W5MNW-IP20</b>
			398 lm/m	80 lm/W	6000K	2000199	<b>FS25W5MCW-IP20</b>
			355 lm/m	71 lm/W	3000K	2000204	<b>FS25W5MWW-IP65</b>
			362 lm/m	72 lm/W	4000K	2000202	<b>FS25W5MNW-IP65</b>
			355 lm/m	71 lm/W	6000K	2000200	<b>FS25W5MCW-IP65</b>

## 50M LED Strip Kit



### DESCRIPTION

High intensity 15W/m (1470lm/m), Medium intensity 8W/m (720lm/m), Feature lighting 5W/m (370lm/m).

### KEY FEATURES

- Flexible PCB and quality double sided tape makes mounting on curved surfaces a breeze
- Available in warm white, neutral white and cool white
- 5W/m & 8W/m Strips can be cut at 167mm intervals
- 15W/m strips can be cut at 100mm intervals
- Dimmable drivers available - See page 72

### APPLICATIONS

Cafes, Restaurants, Lobbies, Stairs, Cove Lighting, Feature Lighting

### Standards



	FEATURES	POWER PER METER	LUMEN PER METER	lm/W	CCT	SAP CODE	PRODUCT CODE
High Intensity	IP20 24VDC	15 W/m	1555 lm/m	104 lm/W	3000K	2001050	<b>FS15W1MWW-IP20x50M</b>
			1660 lm/m	111 lm/W	4000K	2001049	<b>FS15W1MNNW-IP20x50M</b>
			1564 lm/m	104 lm/W	6000K	2001048	<b>FS15W1MCW-IP20x50M</b>
Medium Intensity	IP20 24VDC	8 W/m	740 lm/m	93 lm/W	3000K	2001047	<b>FS8W1MWW-IP20x50M</b>
			808 lm/m	101 lm/W	4000K	2001046	<b>FS8W1MNNW-IP20x50M</b>
			784 lm/m	98 lm/W	6000K	2001045	<b>FS8W1MCW-IP20x50M</b>
Low Intensity	IP20 24VDC	5 W/m	382 lm/m	76 lm/W	3000K	2001044	<b>FS5W1MWW-IP20x50M</b>
			410 lm/m	82 lm/W	4000K	2001043	<b>FS5W1MNNW-IP20x50M</b>
			398 lm/m	80 lm/W	6000K	2001042	<b>FS5W1MCW-IP20x50M</b>

### Dimensions



Dimmable LED Driver Replacement available, see **p196** for options.

# FLEXION RGB LED STRIP

## 5M LED Strip Kit

70

TRACKLIGHT / LED STRIP



### DESCRIPTION

An RGB strip with remote control for intensity, colour and sequence.

### KEY FEATURES

- Flexible PCB and quality 3M double sided tape makes mounting on curved surfaces a breeze
- 24 Button IR remote control with multiple functions
- Selection of 20 modes and 15 colours including white
- Complete with driver and 1.2m flex and plug included for easy installation

### APPLICATIONS

Cafes, Restaurants, Lobbies, Stairs, Cove Lighting, Feature Lighting

### Standards



FEATURES	POWER PER METER	LUMEN PER METER	lm/W	SAP CODE	PRODUCT CODE
IP54 24VDC	8 W/m	60 lm/m	<b>R</b>	2001480	<b>FS40W5MRGB30-IP54</b>
		110 lm/m	<b>G</b>		
		30 lm/m	<b>B</b>		
		200 lm/m	White		
IP54 24VDC	15 W/m	120 lm/m	<b>R</b>	2001472	<b>FS75W5MRGB60-IP54</b>
		220 lm/m	<b>G</b>		
		60 lm/m	<b>B</b>		
		400 lm/m	White		

### Dimensions

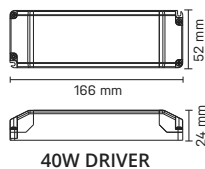
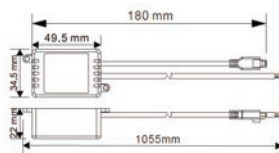

FLEXION RGB 40W

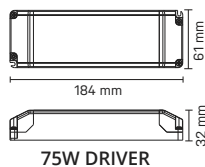

75W DRIVER

## 50M LED Strip Kit



Image for demonstration purpose only.

### DESCRIPTION

An 50m roll of RGB strip with remote control for intensity, colour and sequence.

### KEY FEATURES

- Flexible PCB and quality 3M double sided tape makes mounting on curved surfaces a breeze
- 24 Button IR remote control with multiple functions
- Selection of 20 modes and 15 colours including white
- 8W/m strip can be cut at 167mm intervals
- 15W/m strip can be cut at 100mm intervals

### APPLICATIONS

Cafes, Restaurants, Lobbies, Stairs, Cove Lighting, Feature Lighting

### Standards



FEATURES	POWER PER METER	LUMEN PER METER	lm/W	CUT LENGTH	PRODUCT CODE
IP20 24VDC	8 W/m	60 lm/m	<b>R</b>	167mm	<b>FS8W5MRGB30-IP20x50M</b>
		110 lm/m	<b>G</b>		
		30 lm/m	<b>B</b>		
		200 lm/m	White		
IP20 24VDC	15 W/m	120 lm/m	<b>R</b>	100 mm	<b>FS15W5MRGB60-IP-20x50M</b>
		220 lm/m	<b>G</b>		
		60 lm/m	<b>B</b>		
		400 lm/m	White		

### Dimensions

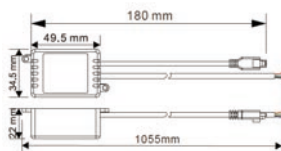



# FLEXION DRIVERS



## KEY FEATURES

- The Constant Voltage Dimmable or Non-Dimmable Driver is for Haneco strip lights (FLEXION) specified to 24V
- Choose dimmable or non dimmable
- Choose indoor IP20 or outdoor up to IP67 rated
- Choose by wattage required

## Haneco Driver Calculation Assistant

Strip intensity X Customised Lengths = Total Wattage Needed\*

	WATT/M	X	LENGTH	=	TOTAL WATT	SUITABLE DRIVERS
Example	8W/m	X	4m	=	32W	50W HD-0050-24V & 40W HN-0040-24V
		X		=		
		X		=		

\*Maximum length of 10m in a single run. Multiple lengths of up to 10m can be operated from a single source of power, provided that the wattage required does not exceed the driver wattage.

## Non-Dimmable Drivers

WATT	MOISTURE RATING	IP RATING	VOLTAGE	CURRENT	DIMENSIONS	SAP CODE	PRODUCT CODE
40W	Indoor	20	24V	0-1.7A	L165xW52xH25mm	2000918	<b>HN-0040-24V</b>
75W	Indoor	20	24V	0-3.15A	L183xW60xH31mm	2000988	<b>HN-0075-24V</b>
75W	Outdoor	65	24V	0-3.15A	L186xW64xH39mm	2000611	<b>HN-0075-24V-IP65</b>
100W	Outdoor	67	24V	0-4.2A	L191xW70xH40mm	2000613	<b>HN-0100-24V</b>
150W	Outdoor	67	24V	0-6.3A	L280xW160xH50mm	2000616	<b>HN-0150-24V</b>
240W	Outdoor	67	24V	0-10A	L249xW72xH40mm	2000265	<b>HN-0240-24V</b>

NB: Outdoor driver is IP67 refer p197 for IP rating standards details,

## Dimmable Drivers

WATT	MOISTURE RATING	IP RATING	VOLTAGE	CURRENT	DIMENSIONS	SAP CODE	PRODUCT CODE
25W	Indoor	20	24V	0.2-1.04A	L128xW52xH30mm	2000828	<b>HD-0025-24V</b>
50W	Indoor	20	24V	0.5-2.08A	L184xW61xH32mm	2000829	<b>HD-0050-24V</b>
200W	Outdoor	67	24V	2.7-8.3A	L249xW72xH40mm	2000830	<b>HD-0200-24V</b>

NB: Outdoor driver is IP67 refer p197 for IP rating standards details,

# FLEXION ACCESSORY

## UNIVERSAL



TYPE	FITS	PRODUCT CODE
IP65 SEALER	FLEXION IP65	<b>FLEXSEALER</b>



TYPE	FITS	PRODUCT CODE
IP65 TERMINAL	FLEXION IP65	<b>FLEXCOVER</b>



TYPE	FITS	PRODUCT CODE
SADDLES	FLEXION IP65	<b>FLEXSDL</b>

**SINGLE COLOUR**

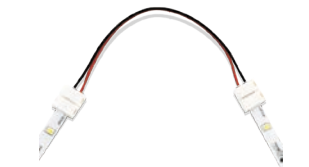

TYPE	FITS	PRODUCT CODE
JOINER	FLEXION IP20 & IP65	<b>FLEXJNR</b>

TYPE	FITS	PRODUCT CODE
RIGHT ANGLE JOINER	FLEXION IP20 & IP65	<b>FLEXCNR</b>

TYPE	FITS	PRODUCT CODE
IP65 MALE TO	FLEXION IP65	<b>FLEXMFC</b>

TYPE	FITS	PRODUCT CODE
5MM STRIP TO POWER	FLEXION IP20 & IP65	<b>FLEXS-P5MIP20</b>

TYPE	FITS	PRODUCT CODE
150MM STRIP TO POWER	FLEXION IP20 & IP65	<b>FLEXS-P10MM</b>

TYPE	FITS	PRODUCT CODE
150MM STRIP TO STRIP CONNECTOR	FLEXION IP20 & IP65	<b>FLEXS-P10MM</b>

TYPE	FITS	PRODUCT CODE
30M STRIP CABLE	FLEXION IP20 & IP65	<b>FLEXCBL30M</b>

## RGB



TYPE	FITS	PRODUCT CODE
JOINER	FLEXION RGB	<b>FLEXJNR-RGB</b>

TYPE	FITS	PRODUCT CODE
JOINER	FLEXION RGB	<b>FLEXCNR-RGB</b>

TYPE	FITS	PRODUCT CODE
Controller to RGB Strip connector	FLEXION RGB	<b>FLEX-CTRL-RGB</b>

TYPE	FITS	PRODUCT CODE
RGB Strip to wire Connector	FLEXION RGB	<b>FLEX-WIRE-RGB</b>



# PARALLAX

76

## Surface Mount Aluminium Profile

The stylish PARALLAX LED Profile range comes with different shape and sizes for different applications. Our surface mount range includes low profile, square and up/down extrusions that will suit any design requirements.

TRACKLIGHT / LED STRIP

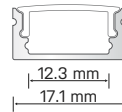

TYPE	LENGTH	FITS	SAP CODE	PRODUCT CODE
17mm Diffuser Low Profile	2M	1 LED Strip IP20	2000995	<b>PARALLAX17X8LP2M</b>

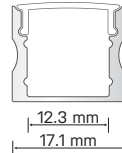

TYPE	LENGTH	FITS	SAP CODE	PRODUCT CODE
17mm Diffuser Low Profile	2M	1 LED Strip IP20/IP65	2000997	<b>PARALLAX17X15SQ2M</b>

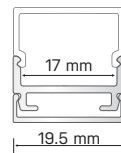

TYPE	LENGTH	FITS	SAP CODE	PRODUCT CODE
20mm Diffuser 180° Wide Beam	2M	1 LED Strip IP20/IP65	2000999	<b>PARALLAX20X20SQ2M</b>

## Recessed Aluminium Profile

The stylish PARALLAX LED Profile range comes with different shape and sizes for different applications. Our recessed range comes in different width that will suit any discreet design requirements.



TYPE	LENGTH	FITS	SAP CODE	PRODUCT CODE
23mm Curve Diffuser	2M	1 LED Strip IP20	2001001	PARALLAX23REC2M

## Corner Aluminium Profile

The stylish PARALLAX LED Profile range comes with different shape and sizes for different applications. The corner range comes in a square or round diffuser.



TYPE	LENGTH	FITS	SAP CODE	PRODUCT CODE
23mm Round Diffuser	2M	1 LED Strip IP20/IP65	2001009	PARALLAXCNR23RD2M



**O2 Performance, Bokarina Sunshine Coast QLD  
completed by Stay Bright Electrical, Burpengary QLD**

With LED highbays mounted high above expensive and sensitive exercise equipment, a reliable highbay such as SKYPAD was a must for this client as moving and recalibrating equipment can be very costly. 24v FLEXION LED strip made it easy to run long lengths of LED strip without the limitations of typical 12v strip which can't extend past 5m; a crucial requirement when running over 500m of strip lighting. Ample stock on hand made the sourcing the hardware easy.

**Featured Products: PARALLAX, FLEXION, SKYPAD & VIVA.**









*Designed, manufactured and tested for Australian conditions, the Haneco range of contemporary battens combines style and outstanding performance.*

*The multitude of options available provides a comprehensive offering for your creative and practical requirements.*

*Offering solo, linkable and suspended solutions.*

# BATTEN

## INDOOR BATTEN



ATEN **p84**



VISTALITE **p86**



VISTA **p88**



BLADE **p90**



OXFORD **p92**



BARE BATTEN **p93**

## OUTDOOR BATTEN



DURALITE **p96**



TRIPROOF **p98**



SENTRY **p101**

INDOOR BATTEN



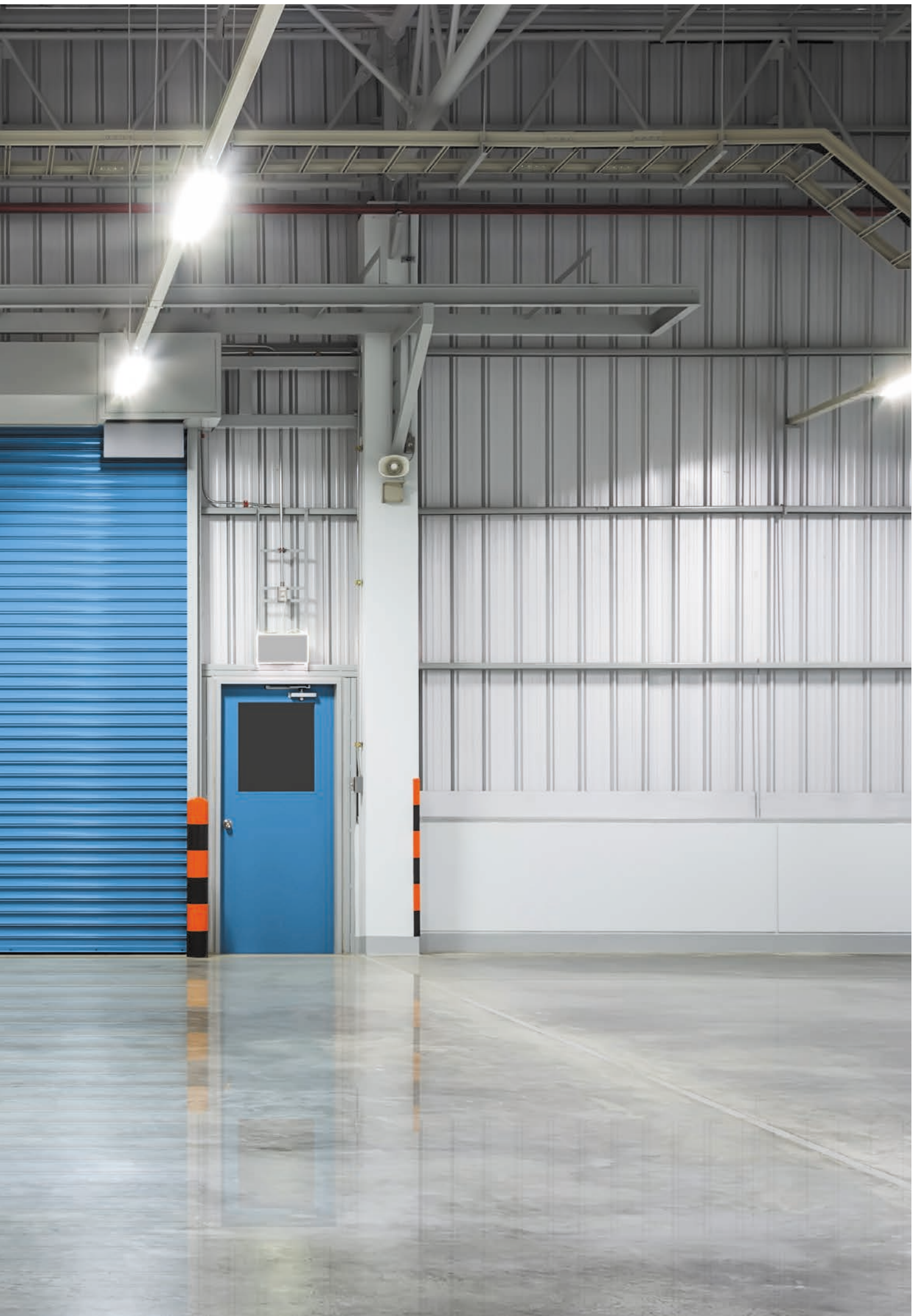



# ATEN COMING SOON...

## Linkable LED Batten



### DESCRIPTION

ATEN batten comes with tricolour selection and mounting accessories that allows for quick and easy installation. It's compact and seamless connection makes it ideal for any accent lighting, cove lighting, shelves, under cabinet and seamless linear lighting applications

### KEY FEATURES

- Selectable colour temperature - 4000K, 4700K and 5700K
- Available in 300mm, 600mm, 900mm and 1200mm
- Comes with mounting and connecting accessories for quick and easy installation
- Supplied with flex and plug

### APPLICATIONS

Residential, Schools, Offices, Retails

### Dimensions

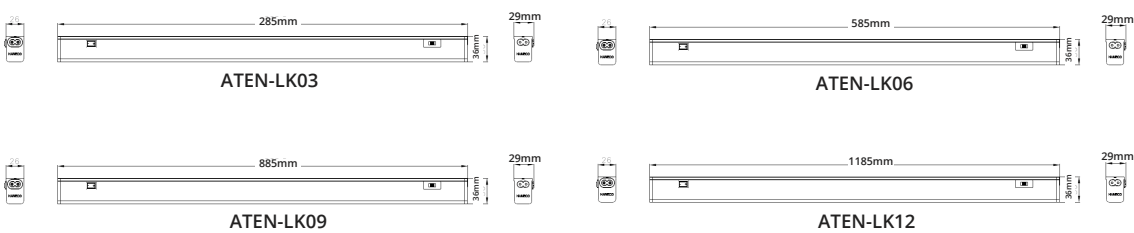

standards



FEATURE	POWER	LUMEN	lm/W	CCT	WEIGHT	SAP CODE	PRODUCT CODE
300mm	4.5W	410 lm	91 lm/W	3000K	0.16 kg	-	<b>ATEN-LK03</b>
		480 lm	107 lm/W	4000K			
		450 lm	100 lm/W	5700K			
600mm	9W	810 lm	41 lm/W	4000K	0.23 kg	2001883	<b>ATEN-LK06</b>
		1040 lm	52 lm/W	4700K			
		990 lm	50 lm/W	5700K			
900mm	13W	1170 lm	90 lm/W	3000K	0.32 kg	-	<b>ATEN-LK09</b>
		1495 lm	115 lm/W	4000K			
		1430 lm	110 lm/W	5700K			
1200mm	18W	1700 lm	85 lm/W	4000K	0.38 kg	2001884	<b>ATEN-LK12</b>
		2040 lm	102 lm/W	4700K			
		2000 lm	100 lm/W	5700K			

# VISTALITE

## Narrow Body LED Batten



### DESCRIPTION

The VISTALITE is a sleek narrow body batten designed as an ideal solution for new installation or replacing single fluorescent battens where lower cost option is required but without compromising on features.

### KEY FEATURES

- Selectable colour temperature - 4000K, 4700K and 5700K
- Dual power selection available in 1200mm length only
- Insect resistant LED module
- Quick and easy installation
- Intellisensor motion sensor with corridor function available
- Lithium Iron Phosphate (LiFePO4) battery emergency version available

### APPLICATIONS

Residential, Schools, Offices, Retails, Factories, Carpark, Stairwells

**Dimensions**

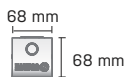
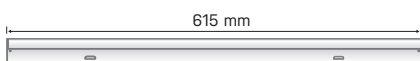

VSL20W06-TRI

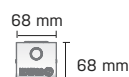
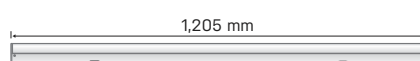

VSL20W40W12-TRI

standards



NOMINAL LENGTH 615MM

STANDARD MODE		LOW POWER MODE			EMERGENCY SPECIFICATION							
FEATURE	POWER	LUMEN	lm/W	POWER	LUMEN	lm/W	CCT	WEIGHT	EMERGENCY CLASSIFICATION	BATTERY TYPE	SAP CODE	PRODUCT CODE
	20W	2150 lm	108 lm/W	N/A	N/A	N/A	4000K	0.90 Kg	-	-	2001630	<b>VSL20W06-TRI</b>
		2250 lm	113 lm/W				4700K					
		2130 lm	107 lm/W				5700K					
Emergency	20W	2150 lm	108 lm/W	N/A	N/A	N/A	4000K	1.10 kg	C0=D50 C90=D32	LiFePO4	2001631	<b>VSL20W06-TRI-EM</b>
		2250 lm	113 lm/W				4700K					
		2130 lm	107 lm/W				5700K					

NOMINAL LENGTH 1205MM

STANDARD MODE		LOW POWER MODE			EMERGENCY SPECIFICATION							
FEATURE	POWER	LUMEN	lm/W	POWER	LUMEN	lm/W	CCT	WEIGHT	EMERGENCY CLASSIFICATION	BATTERY TYPE	SAP CODE	PRODUCT CODE
	40W	4220 lm	106 lm/W	20W	2330 lm	117l m/W	4000K	1.80 kg	-	-	2001634	<b>VSL20W40W12-TRI</b>
		4540 lm	114l m/W				4700K					
		4610 lm	115 lm/W				5700K					
Emergency	40W	4220 lm	106 lm/W	20W	2330 lm	117 lm/W	4000K	2.00 kg	C0=D50 C90=D32	LiFePO4	2001635	<b>VSL20W40W12-TRI-EM</b>
		4540 lm	114 lm/W				4700K					
		4610 lm	115 lm/W				5700K					



# VISTA LED batten



## DESCRIPTION

The perfect LED replacement for conventional battens, VISTA offers efficiency with excellent light distribution. Intellisensor motion sensor with corridor function and dual power selection further enhance energy savings and Lithium Iron Phosphate (LiFePO4) battery version is available where emergency lighting is required.

## KEY FEATURES

- Selectable colour temperature - 4000K, 4700K and 5700K
- Dual power selection available in 1200mm length only
- Quick and easy installation
- Intellisensor motion sensor with corridor function available
- Lithium Iron Phosphate (LiFePO4) battery emergency version available

## APPLICATIONS

Residential, Schools, Offices, Retails, Factories, Carpark, Stairwells

## Dimensions

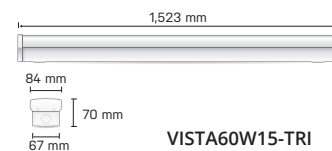
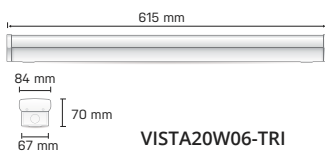

Dimmable LED Driver Replacement available for 20/40W  
see p194 for options.

standards



NOMINAL LENGTH 615MM

STANDARD MODE

LOW POWER MODE

EMERGENCY SPECIFICATION

FEATURE	POWER	LUMEN	lm/W	POWER	LUMEN	lm/W	CCT	WEIGHT	EMERGENCY CLASSIFICATION	BATTERY TYPE	SAP CODE	PRODUCT CODE
	20W	2000 lm	100 lm/W	N/A	N/A	N/A	4000K	0.80 kg	-	-	2001157	<b>VIST-A20W06-TRI</b>
		2200 lm	110 lm/W				4700K					
		2100 lm	105 lm/W				5700K					
Emergency	20W	2000 lm	100 lm/W	N/A	N/A	N/A	4000K	2.00 kg	C0=D50, C90=D32	LiFePO4	2001158	<b>VISTA20W06-TRI-EM</b>
		2200 lm	110 lm/W				4700K					
		2100 lm	105 lm/W				5700K					

NOMINAL LENGTH 1221MM

STANDARD MODE

LOW POWER MODE

EMERGENCY SPECIFICATION

FEATURE	POWER	LUMEN	lm/W	POWER	LUMEN	lm/W	CCT	WEIGHT	EMERGENCY CLASSIFICATION	BATTERY TYPE	SAP CODE	PRODUCT CODE
	40W	4540 lm	114 lm/W	20W	2510 lm	126 lm/W	4000K	1.90 kg	-	-	2001161	<b>VISTA20/40W12-TRI</b>
		4880 lm	122 lm/W				4700K					
		4470 lm	112 lm/W				5700K					
Emergency	40W	4540 lm	114 lm/W	20W	2510 lm	126 lm/W	4000K	2.10 kg	C0=D50, C90=D32	LiFePO4	2001063	<b>VISTA20/40W12-TRI-EM</b>
		4880 lm	122 lm/W				4700K					
		4470 lm	112 lm/W				5700K					
Intellisensor	40W	4540 lm	114 lm/W	N/A	N/A	N/A	4000K	1.90 kg	-	-	2001064	<b>VISTA40W12-TRI-SS</b>
		4880 lm	122 lm/W				4700K					
		4470 lm	112 lm/W				5700K					
Intellisensor Emergency	40W	4540 lm	114 lm/W	N/A	N/A	N/A	4000K	2.10 kg	C0=D50, C90=D32	LiFePO4	2001065	<b>VISTA40W12-TRI-SS-EM</b>
		4880 lm	122 lm/W				4700K					
		4470 lm	112 lm/W				5700K					
	60W	6300 lm	105 lm/W	N/A	N/A	N/A	4000K	2.5 kg	-	-	200162	<b>VISTA60W15-TRI</b>
		6690 lm	112 lm/W				4700K					
		6250 lm	104 lm/W				5700K					

# OXFORD COMING SOON...

## 90 Wide Body LED Batten

BATTEN

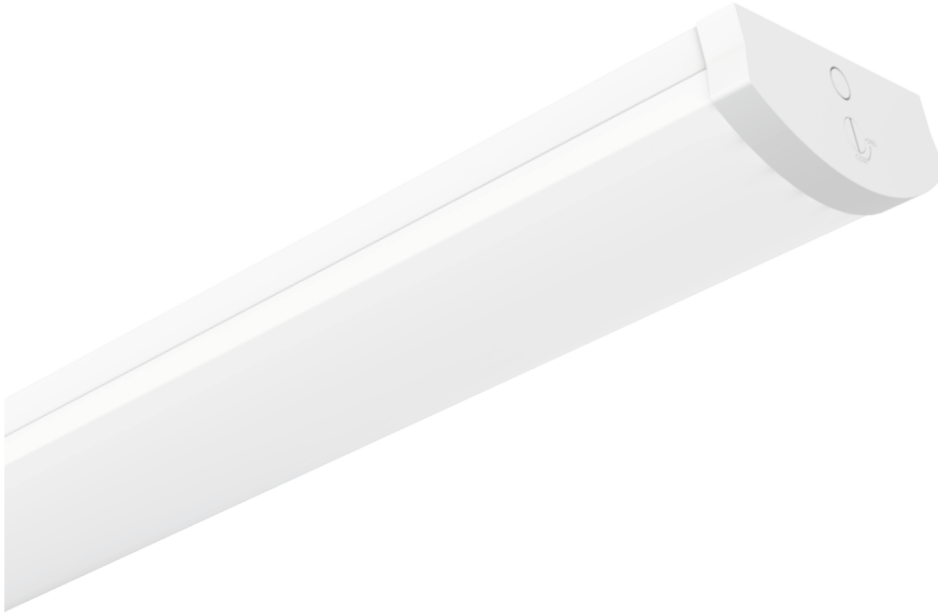

### DESCRIPTION

Oxford is an extra wide body batten with aesthetically pleasing and low glare design to minimize clutter on the ceiling for offices, retails and schools applications.

### KEY FEATURES

- Selectable colour temperature - 4000K, 4700K and 5700K
- Dual power selection
- Low glare design
- Quick and easy installation
- Lithium Iron Phosphate (LiFePO4) battery emergency version available

### APPLICATIONS

Schools, Offices, Retails

### Dimensions

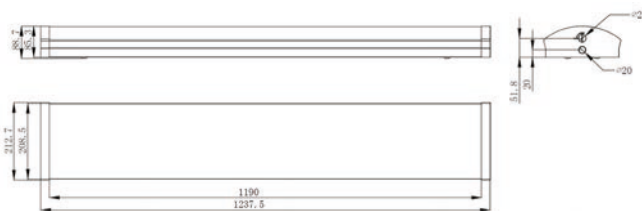

standards



FEATURE	POWER	LUMEN	lm/W	POWER	LUMEN	lm/W	CCT	WEIGHT	SAP CODE	PRODUCT CODE
1200mm	40W	4000 lm	100 lm/W	20W	2100 lm	105 lm/W	4000K	3.55 kg	2001885	<b>OXFORD12</b>
		4400 lm	110 lm/W		2300 lm	115 lm/W	4700K			
		4000 lm	100 lm/W		2100 lm	105 lm/W	5700K			
1200mm	40W	4000 lm	100 lm/W	20W	2100 lm	105 lm/W	4000K	4.00 kg	2001886	<b>OXFORD12-EM</b>
		4400 lm	110 lm/W		2300 lm	115 lm/W	4700K			
		4000 lm	100 lm/W		2100 lm	105 lm/W	5700K			
1200mm	40W	4000 lm	100 lm/W	20W	2100 lm	105 lm/W	4000K	3.55 kg	2001887	<b>OXFORD12-SS</b>
		4400 lm	110 lm/W		2300 lm	115 lm/W	4700K			
		4000 lm	100 lm/W		2100 lm	105 lm/W	5700K			
1200mm	40W	4000 lm	100 lm/W	20W	2100 lm	105 lm/W	4000K	4.00 kg	2001888	<b>OXFORD12-EM-SS</b>
		4400 lm	110 lm/W		2300 lm	115 lm/W	4700K			
		4000 lm	100 lm/W		2100 lm	105 lm/W	5700K			



# BLADE

## Low Profile LED Batten

BATTEN



### DESCRIPTION

The BLADE is ideal when a low profile batten is needed. This aesthetically pleasing batten delivers cost savings without compromising light output.

### KEY FEATURES

- 30mm low profile design
- 100mm wide body ideal for retrofitting applications
- Easy installation

### APPLICATIONS

Residential, Schools, Offices, Retails, Factories, Carpark, Stairwells

### Standards



POWER	LUMEN	lm/W	CCT	WEIGHT	SAP CODE	PRODUCT CODE
20W	2020 lm	101 lm/W	4000K	0.30 kg	2000071	<b>BLADE20W06SM-4K</b>
	1890 lm	95 lm/W	6000K		2000073	<b>BLADE20W06SM-6K</b>

POWER	LUMEN	lm/W	CCT	WEIGHT	SAP CODE	PRODUCT CODE
40W	3970 lm	99 lm/W	4000K	0.66 kg	2000075	<b>BLADE40W12SM-4K</b>
	3770 lm	90 lm/W	6000K		2000076	<b>BLADE40W12SM-6K</b>

### Dimensions

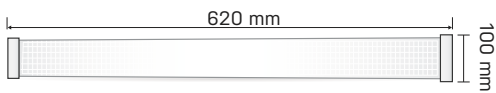

± 30 mm

BLADE20W06SM-4K

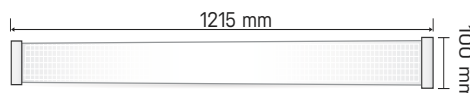

± 30 mm

BLADE40W12SM-4K

# BARE BATTEN

## Bare Batten for LED Tubes



### DESCRIPTION

The BARE BATTEN is designed for easy installation that delivers substantial cost savings over its lifespan.

### KEY FEATURES

- Powder coated steel construction
- Single or twin tube configuration
- Large terminal block for easy installation
- Designed for Haneco LED tube (Not included)

### APPLICATIONS

Residential, Schools, Offices, Retailers, Factories, Carpark, Stairwells

Standards



FEATURE	NORMAL	SAP CODE	PRODUCT CODE
Single tube batten	1232mm	2000375	<b>SDB1200</b>
Twin tube batten	1232mm	2000452	<b>TDB1200</b>

\* Please refer to p173 for LED tube range.

Dimensions

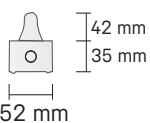
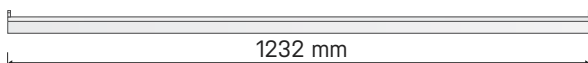

SINGLE

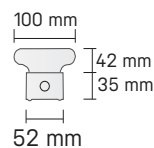
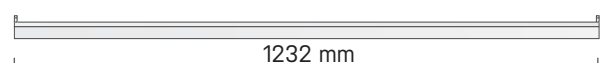

DOUBLE

OUTDOOR BATTEN









# DURALITE

## Narrow Body LED Weatherproof Batten



### DESCRIPTION

The DURALITE is a sleek narrow body weatherproof batten designed as an ideal solution for new installation or replacing single fluorescent battens where lower cost option is required but without compromising on features.

### KEY FEATURES

- Selectable colour temperature - 4000K and 5000K
- Dual power selection available in 1200mm length only
- Quick and easy installation
- Lithium Iron Phosphate (LiFePO4) battery emergency version available

### APPLICATIONS

Residential, Schools, Factories, Carpark, Stairwells, Public Areas

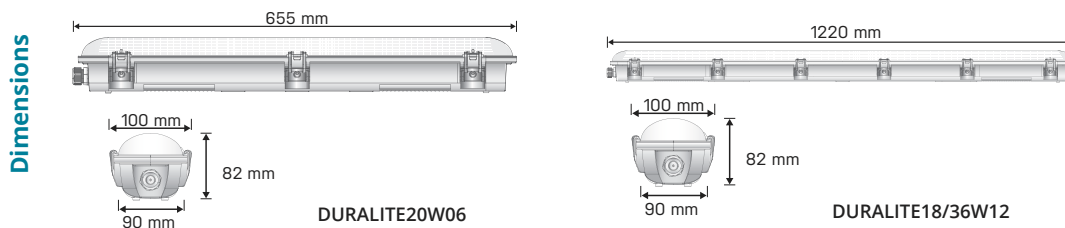

standards



NOMINAL LENGTH 655MM

STANDARD MODE				LOW POWER MODE				EMERGENCY SPECIFICATION				
FEATURE	POWER	LUMEN	lm/W	POWER	LUMEN	lm/W	CCT	WEIGHT	EMERGENCY CLASSIFICATION	BATTERY TYPE	SAP CODE	PRODUCT CODE
	20W	2090 lm 2070 lm	105 lm/W 104 lm/W	N/A	N/A	N/A	4000K 5000K	1.05 kg	-	-	2001496	<b>DURALITE 20W06</b>
Emergency	20W	2090 lm 2070 lm	105 lm/W 104 lm/W	N/A	N/A	N/A	4000K 5000K	1.30 kg	C0=D50 C90=D32	LiFePO4	2001497	<b>DURALITE 20W06-EM</b>

NOMINAL LENGTH 1220MM

STANDARD MODE				LOW POWER MODE				EMERGENCY SPECIFICATION				
FEATURE	POWER	LUMEN	lm/W	POWER	LUMEN	lm/W	CCT	WEIGHT	EMERGENCY CLASSIFICATION	BATTERY TYPE	SAP CODE	PRODUCT CODE
	36W	4160 lm 4150 lm	116 lm/W 115 lm/W	18W	2720 lm 2680 lm	151 lm/W 149 lm/W	4000K 5000K	2.00 kg	-	-	2001498	<b>DURALITE 18/36W12</b>
Emergency	36W	4160 lm 4150 lm	116 lm/W 115 lm/W	18W	2720 lm 2680 lm	151 lm/W 149 lm/W	4000K 5000K	2.40 kg	C0=D80 C90=D50	LiFePO4	2001499	<b>DURALITE 18/36W12-EM</b>

# TRIPROOF

## Weatherproof LED Batten



### DESCRIPTION

The perfect LED replacement for conventional weatherproof battens, the robust TRIPROOF offers IP65 weatherproof and IK08 impact rating. Intellisensor motion sensor with corridor function and dual power selection further enhance energy savings and Lithium Iron Phosphate (LiFePO4) battery version is available where emergency lighting is required.

### KEY FEATURES

- Selectable colour temperature - 4000K, 5000K and 6500K
- Dual power selection available in 1200mm length only
- Quick and easy installation
- Intellisensor motion sensor with corridor function available
- Lithium Iron Phosphate (LiFePO4) battery emergency version available

### APPLICATIONS

Residential, Schools, Factories, Carpark, Stairwells, Public Areas

**standards**



**NOMINAL LENGTH 618MM**

STANDARD MODE			LOW POWER MODE			EMERGENCY SPECIFICATION						
FEATURE	POWER	LUMEN	lm/W	POWER	LUMEN	lm/W	CCT	WEIGHT	EMERGENCY CLASSIFICATION	BATTERY TYPE	SAP CODE	PRODUCT CODE
	20W	1850 lm	93 lm/W	N/A	N/A	N/A	4000K	2.00 kg	-	-	2001164	<b>TRIPROOF 20W06-TRI</b>
		1990 lm	100 lm/W				5000K					
		1850 lm	93 lm/W				6500K					
Emergency	20W	1850 lm	93 lm/W	N/A	N/A	N/A	4000K	2.20 kg	C0=D50, C90=D32	LiFePO4	2001165	<b>TRIPROOF 20W06-TRI-EM*</b>
		1990 lm	100 lm/W				5000K					
		1850 lm	93 lm/W				6500K					

**NOMINAL LENGTH 1215MM**

STANDARD MODE			LOW POWER MODE			EMERGENCY SPECIFICATION						
FEATURE	POWER	LUMEN	lm/W	POWER	LUMEN	lm/W	CCT	WEIGHT	EMERGENCY CLASSIFICATION	BATTERY TYPE	SAP CODE	PRODUCT CODE
	40W	4090 lm	102 lm/W	20W	2230 lm	112 lm/W	4000K	2.00 kg	-	-	2001168	<b>TRIPROOF 20/40W12-TRI</b>
		4410 lm	110 lm/W				5000K					
		4050 lm	101 lm/W				1970 lm					
Emergency	40W	4090 lm	102 lm/W	20W	2230 lm	112 lm/W	4000K	2.20 kg	C0=D63, C90=D32	LiFePO4	2001066	<b>TRIPROOF 20/40W12-TRI-EM*</b>
		4410 lm	110 lm/W				5000K					
		4050 lm	101 lm/W				1970 lm					
Intellisensor	40W	4090 lm	102 lm/W	N/A	N/A	N/A	4000K	2.00 kg	-	-	2001067	<b>TRIPROOF 40W12-TRI-SS</b>
		4410 lm	110 lm/W				5000K					
		4050 lm	101 lm/W				6500K					
Intellisensor Emergency	40W	4090 lm	102 lm/W	N/A	N/A	N/A	4000K	2.20 kg	C0=D63, C90=D32	LiFePO4	2001068	<b>TRIPROOF 40W12-TRI-SS-EM*</b>
		4410 lm	110 lm/W				5000K					
		4050 lm	101 lm/W				6500K					

\*TRIPROOF emergency version is IP54.



NOMINAL LENGTH 1515MM

		STANDARD MODE			LOW POWER MODE			EMERGENCY SPECIFICATION				
FEATURE	POWER	LUMEN	lm/W	POWER	LUMEN	lm/W	CCT	WEIGHT	EMERGENCY CLASSIFICATION	BATTERY TYPE	SAP CODE	PRODUCT CODE
	60W	5600lm	93 lm/W	N/A	N/A	N/A	4000K	3.50 kg	-	-	2001170	<b>TRIPROOF 60W15-TRI</b>
		6000lm	100 lm/W				5000K					
		5700lm	95 lm/W				6500K					
Emergency	60W	5600lm	93 lm/W	N/A	N/A	N/A	4000K	3.70 kg	C0=D50, C90=D32	LiFePO4	2001171	<b>TRIPROOF 60W15-TRI-EM</b>
		6000lm	100 lm/W				5000K					
		5700lm	95 lm/W				6500K					

Dimensions

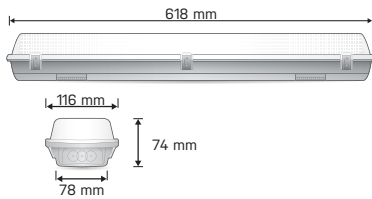

TRIPROOF20W06-TRI

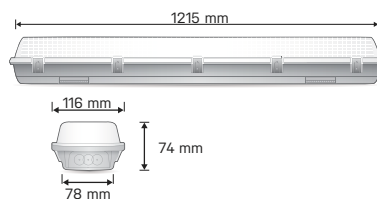

TRIPROOF20/40W12-TRI

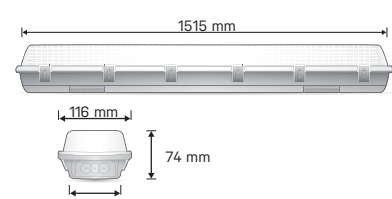

TRIPROOF60W15-TRI

Dimmable LED Driver Replacement available for 20/40W see **p194** for options.

# SENTRY

## Vandal Resistant Batten



### DESCRIPTION

The SENTRY is a robust polycarbonate body and diffuser and this luminaire is designed to withstand tough environment from IP66 weather resistant to IK10 vandal resistant. It is ideal for public areas, schools and community centres.

### FEATURES

- Selectable colour temperature - 2700K, 4000K and 6500K
- Quick and easy installation

### APPLICATIONS

Schools, Retailers, Factories, Carpark, Public areas

### Standards



POWER	LUMEN	lm/W	CCT	WEIGHT	SAP CODE	PRODUCT CODE
12W	1010lm	84 lm/W	2700K	2.00 kg	2001495	<b>SENTRY12W06-TRI</b>
	1225lm	102 lm/W	4000K			
	1200lm	100 lm/W	6500K			

### Dimensions

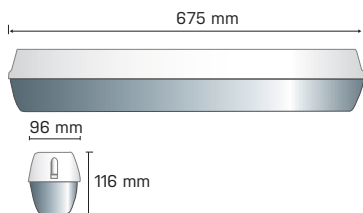

**Oatly Residential Apartment, NSW**  
completed by Global Electirc, NSW

A refurbishment project to replace 2 x 36w batten with our HANECO Triproof 20/40W Tri to reduced the total ownership cost of energy and maintenance.

**Featured Product: TRIPROOF**

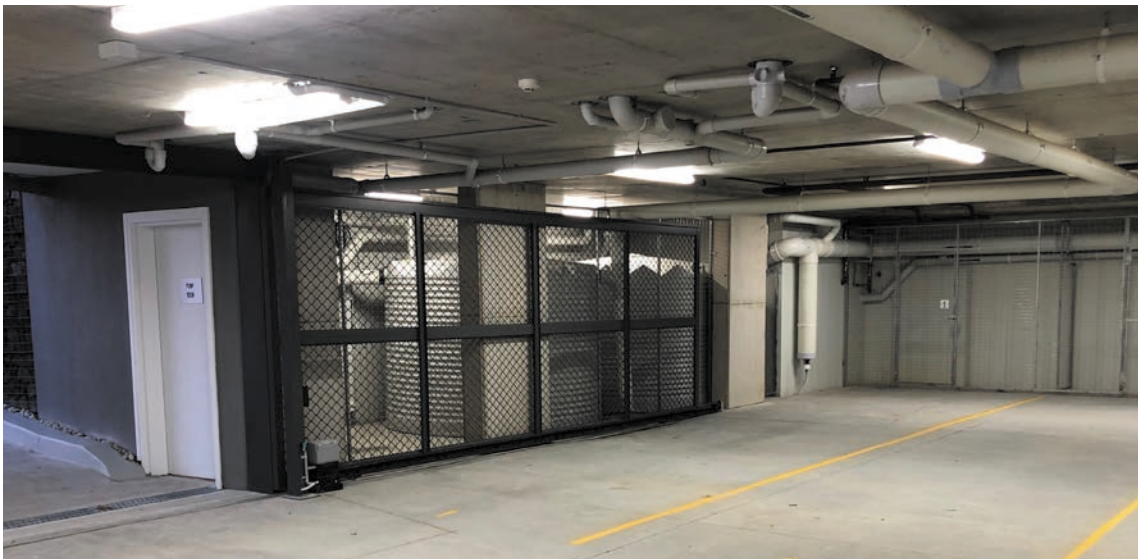

**Sydney Commercial Office, NSW**  
completed by JRP Electircs Australia, NSW

Another successful refurbishment project to replace 2x36W air recessed troffers with our GALAXY panels which air handling frames are required to manufactured within a very short lead time.

**Featured Product: GALAXY**

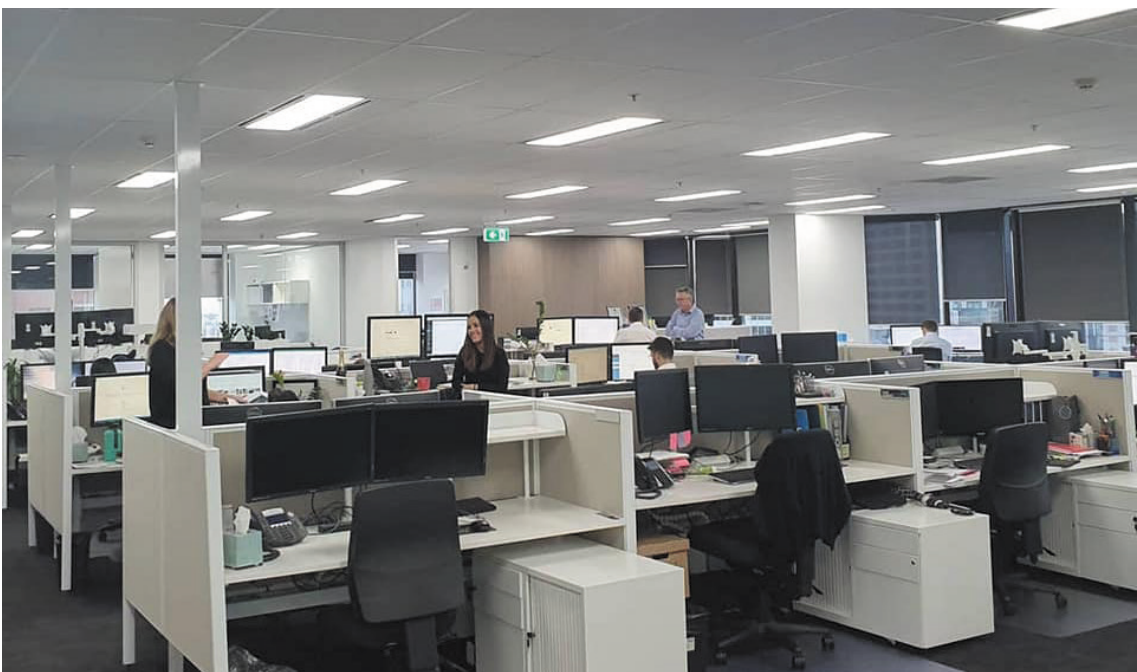



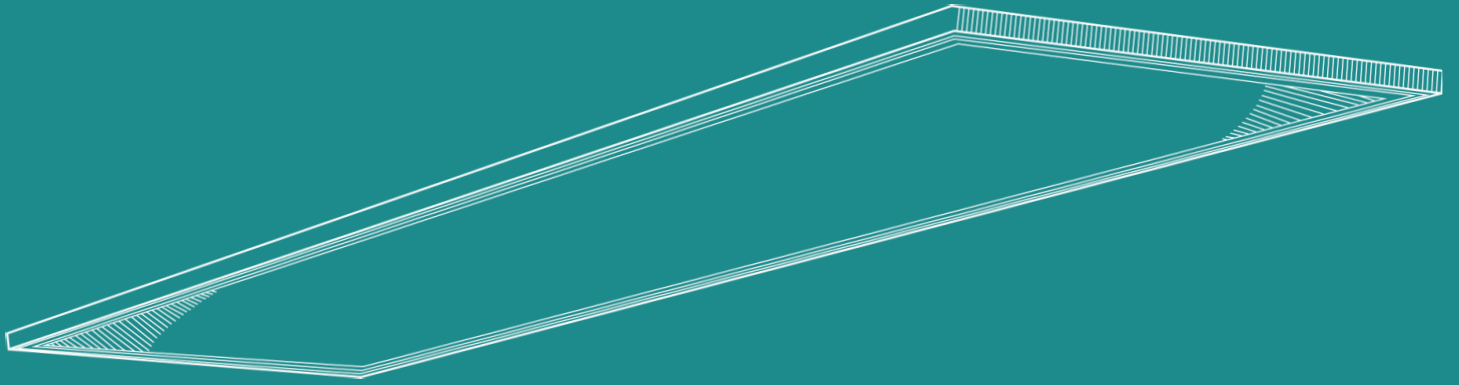

*The Haneco series of LED panel luminaires deliver high performance, low glare with flicker free technology.*

*The Matrix 28W is an outstanding LED solution for the Department of Education & Training, as it delivers impressive efficacy with superior heat dissipation and homogeneous distribution.*

*Supplied as a standard for T-BAR grid suspended ceilings with options for surface mount and suspension mount.*

# PANEL



MATRIX **p107**



GALAXY **p111**

PANEL

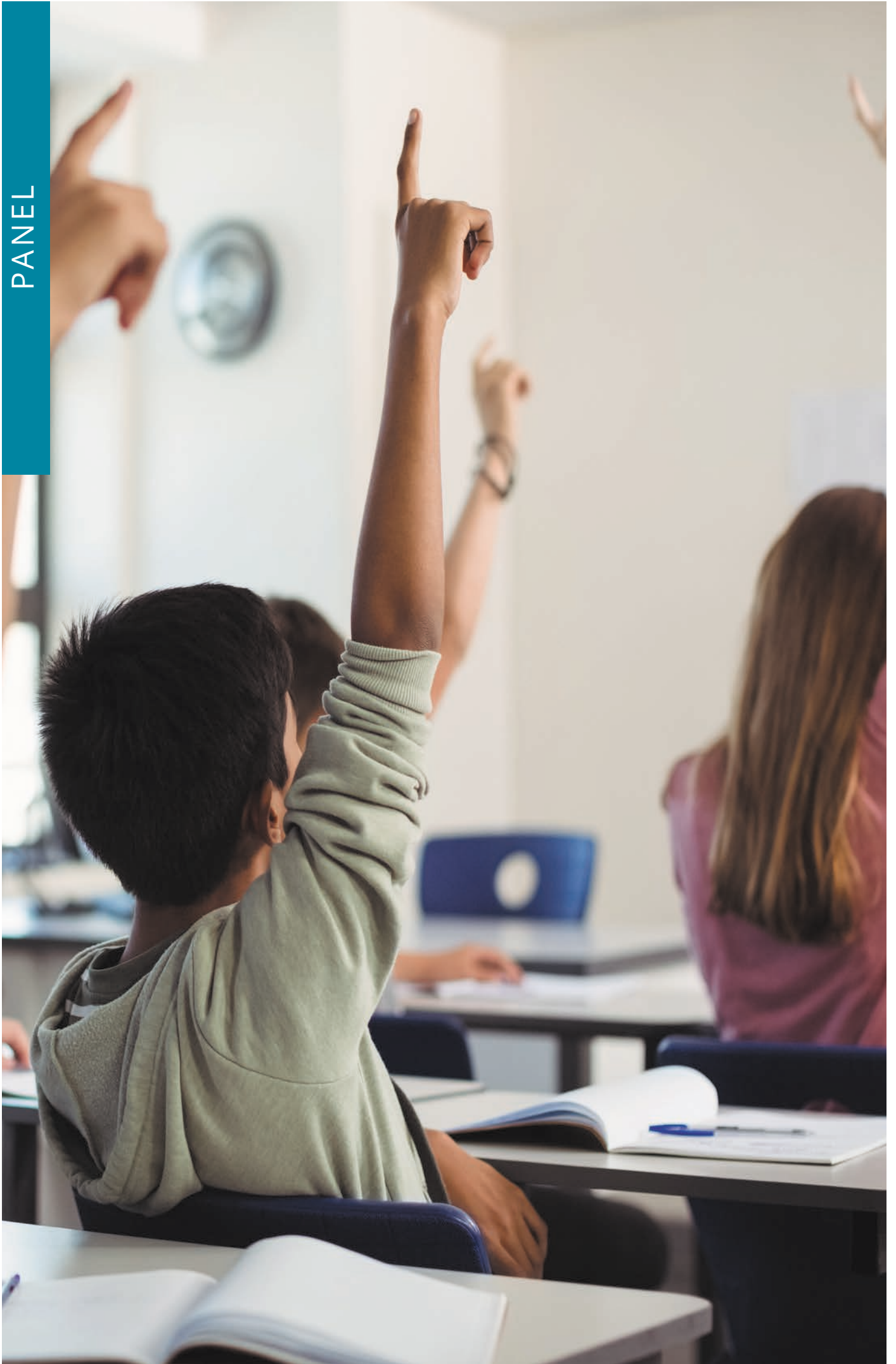

# MATRIX

## Back-lit LED Panel



### DESCRIPTION

The MATRIX is a reliable, back-lit LED panel designed to be a high performance, energy efficient and low glare design ideally for general illumination in commercial applications such as offices and schools.

### KEY FEATURES

- Available in 4000K or 5000K
- Low glare design
- Sturdy powder coated steel housing
- Excellent light distribution
- Complete with remote control gear
- Optional dimmable driver
- Complete with flex and plug for simple installation
- Flicker Free Driver

### APPLICATIONS

Offices, Schools

### Dimensions

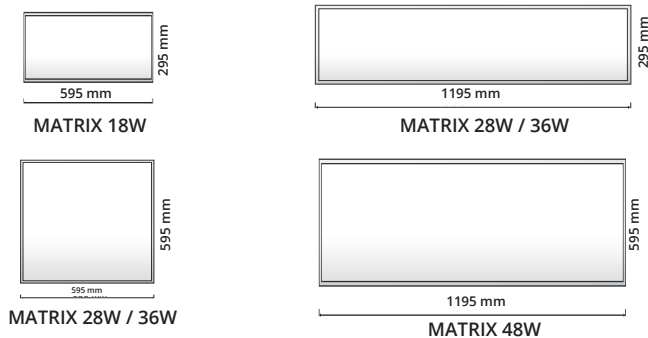

Dimmable LED Driver Replacement available for 600mm length and 1200mm length, see **p195** for options.



Standards



295MM x 595MM

POWER	LUMEN	lm/W	CCT	WEIGHT	SAP CODE	PRODUCT CODE
18W	1760 lm	98 lm/W	4000K	1.00 kg	2001842	<b>MATRIX18W0306-4K</b>
18W	1760 lm	98l m/W	5000K	1.00 kg	2001843	<b>MATRIX18W0306-5K</b>

595MM x 595MM

POWER	LUMEN	lm/W	CCT	WEIGHT	SAP CODE	PRODUCT CODE
28W	3440 lm	123 lm/W	4000K	1.85 kg	2001842	<b>MATRIX28W0606-4K</b>
	3360 lm	116 lm/W	5000K		2001843	<b>MATRIX28W0606-5K</b>
36W	4160 lm	116 lm/W	4000K	1.85 kg	2000343	<b>MATRIX36W0606-4K</b>
	4090 lm	106 lm/W	5000K		2000344	<b>MATRIX36W0606-5K</b>

295MM x 1195MM

POWER	LUMEN	lm/W	CCT	WEIGHT	SAP CODE	PRODUCT CODE
28W	3390 lm	121 lm/W	4000K	1.85 kg	2001862	<b>MATRIX28W0312-4K</b>
	3260 lm	116l m/W	5000K		2001863	<b>MATRIX28W0312-5K</b>
36W	4120 lm	114 lm/W	4000K	1.85 kg	2000341	<b>MATRIX36W0312-4K</b>
	3980 lm	110 lm/W	5000K		2000342	<b>MATRIX36W0312-5K</b>

595MM x 1195MM

POWER	LUMEN	lm/W	CCT	WEIGHT	SAP CODE	PRODUCT CODE
48W	5514 lm	115 lm/W	4000K	3.40 kg	2001851	<b>MATRIX48W0612-4K</b>
	5710 lm	119 m/W	5000K		2001852	<b>MATRIX48W0612-5K</b>

ACCESSORIES	FEATURES	DIMENSIONS	SAP CODE	PRODUCT CODE	
Suspension kit	Steel wire	0.6m - 2.6m	2001880	<b>SUSKIT-MATRIX</b>	
Surface mount frame	Self assemble	Sturdy single piece frame	1275 x 340 x 52mm	2001881	<b>SMPF0312-OP-V2</b>
			300 x 600 x 60mm	2000405	<b>SMPF0306</b>
			600 x 600 x 60mm	2000408	<b>SMPF0606</b>
			300 x 1200 x 60mm	2000406	<b>SMPF0312</b>
			600 x 1200 x 60mm	2000409	<b>SMPF0612</b>
Recess Frame	Plaster Recess Frame		330 x 630 x 41mm	2000357	<b>PLRF0306</b>
			630 x 630 x 41mm	2000359	<b>PLRF0606</b>
			330 x 1230 x 41mm	2000358	<b>PLRF0312</b>
			630 x 1230 x 41mm	2000360	<b>PLRF0612</b>
		Vented Plaster Recess Frames	395 x 1195 x 37mm	2001091	<b>RF0412-AF</b>
		595 x 1195 x 37mm	2000410	<b>RF0612-AF</b>	
Emergency Kit	40W Lithium Battery	-	2000590	<b>EMLED-2.4W-3H-60V 40PL</b>	

Accessories



SUSPENSION KIT



SURFACE MOUNT FRAME



PLASTER RECESS FRAME



VENTED PLASTER RECESS FRAME



40W EMERGENCY KIT

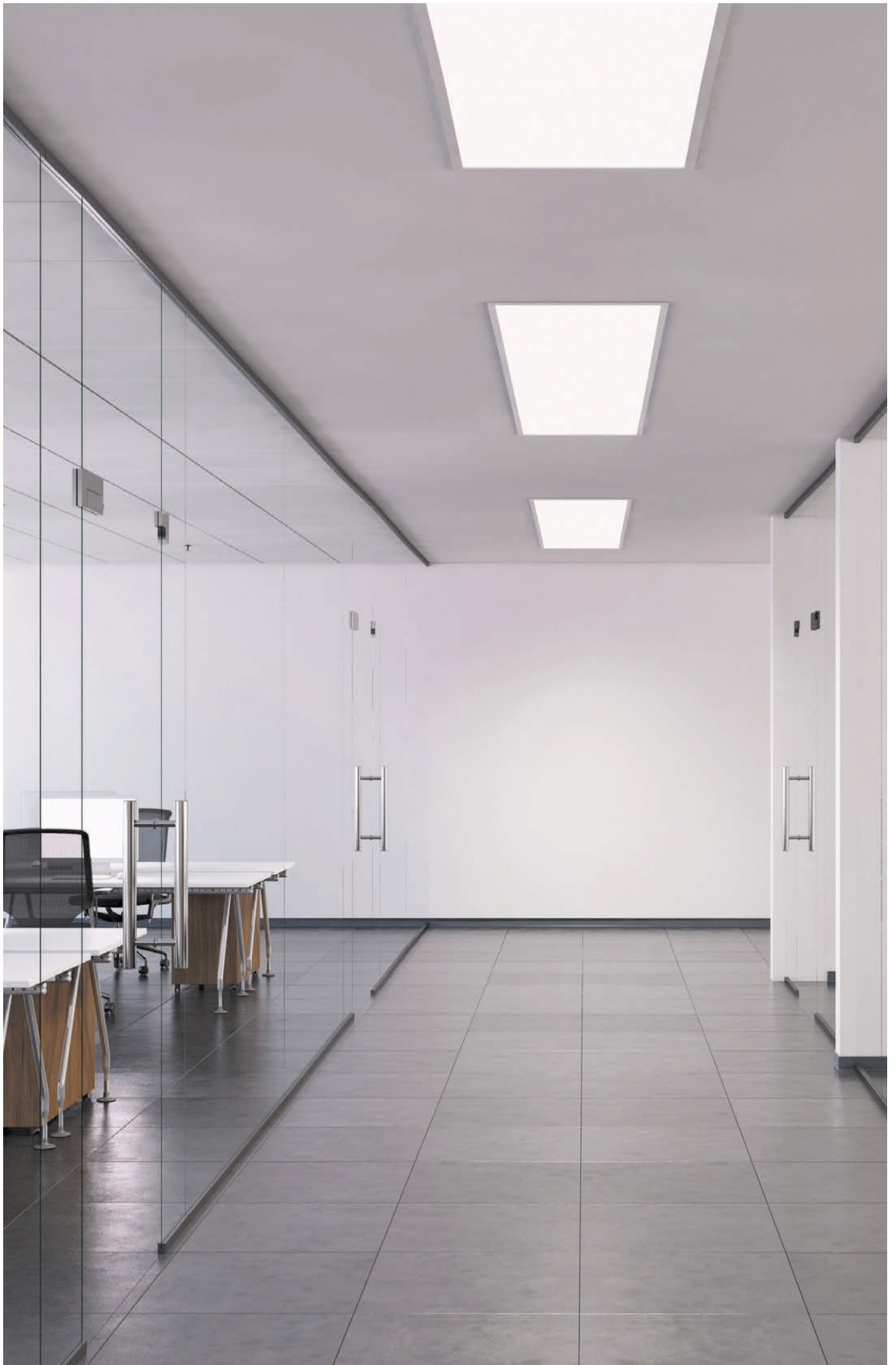

# GALAXY

## 1200mm x 300mm Low Profile LED Panel



### DESCRIPTION

GALAXY LED panel is designed to be a low profile, excellent light distribution and superior efficacy suitable for general illumination in commercial applications and meeting energy rebate scheme requirement.

### KEY FEATURES

- Available in 4000K or 5000K
- Excellent light distribution
- Complete with remote control gear
- Optional dimmable driver
- Complete with flex and plug for simple installation

### APPLICATIONS

Offices, Schools

### Dimensions

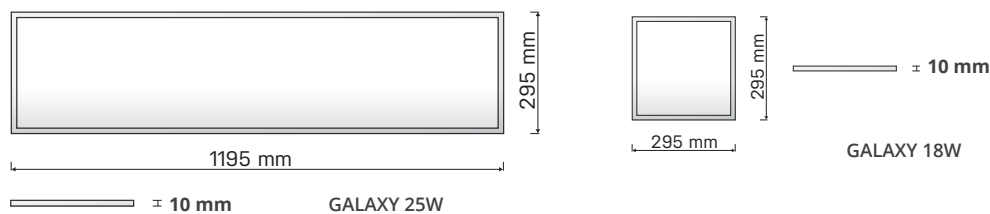

Dimmable LED Driver Replacement available for 1200mm length, see **p195** for options.



Standards



295MM x 1195MM

POWER	LUMEN	lm/W	CCT	WEIGHT	SAP CODE	PRODUCT CODE
17W	1430 lm	85 lm/W	5000K	0.90 kg	2000602	<b>GALAXY0303-5K</b>
25W	3060 lm	122 lm/W	4000K	3.50 kg	2001854	<b>GALAXY25W0312-4K*</b>
	3150 lm	126 lm/W	5000K		2001855	<b>GALAXY25W0312-5K*</b>

\* GALAXY25W0312-4K and GALAXY25W0312-5K are VEU, IPART, REES & HEER Approved.

ACCESSORIES	FEATURES	DIMENSIONS	SAP CODE	PRODUCT CODE
Suspension kit	Steel wire	1m	2001233	<b>PSSKIT-1M-6PCS</b>
		2m	2001234	<b>PSSKIT-2M-6PCS</b>
Surface mount frame	Sturdy single piece frame	1275 x 340 x 52mm	2001881	<b>SMPF0312-OP-V2</b>
	Self assemble frame	300 x 300 x 60mm	2000404	<b>SMPF0303</b>
		300 x 1200 x 60mm	2000406	<b>SMPF0312</b>
Plaster recess frame	Sturdy single piece frame	3330 x 330 x 41mm	2000356	<b>RLRF0303</b>
		330 x 1230 x 41mm	2000358	<b>PLRF0312</b>
	Vented frame	395 x 1195 x 37mm	2001091	<b>RF0412-AF</b>
		595 x 1195 x 37mm	2000410	<b>RF0612-AF</b>

Accessories



SUSPENSION KIT



SINGLE PIECE SURFACE MOUNT FRAME



SELF ASSEMBLE SURFACE MOUNT FRAME



SINGLE PIECE PLASTER RECESS FRAME



VENTED PLASTER RECESS FRAME



**Bridgeman Baptist Community Church, QLD**  
completed by CBD (Cornerstone Building Developments), Mango Hill Qld

With many high priced European brands specified on this project with enormous lead times, HANECO was engaged to assist with cost savings. With quality fittings at a reasonable price, better warranty, local support and goods available in days, not months, HANECO was an easy choice.

**Featured Products: AURORA, CENTAURI, PARX & SKYPAD.**







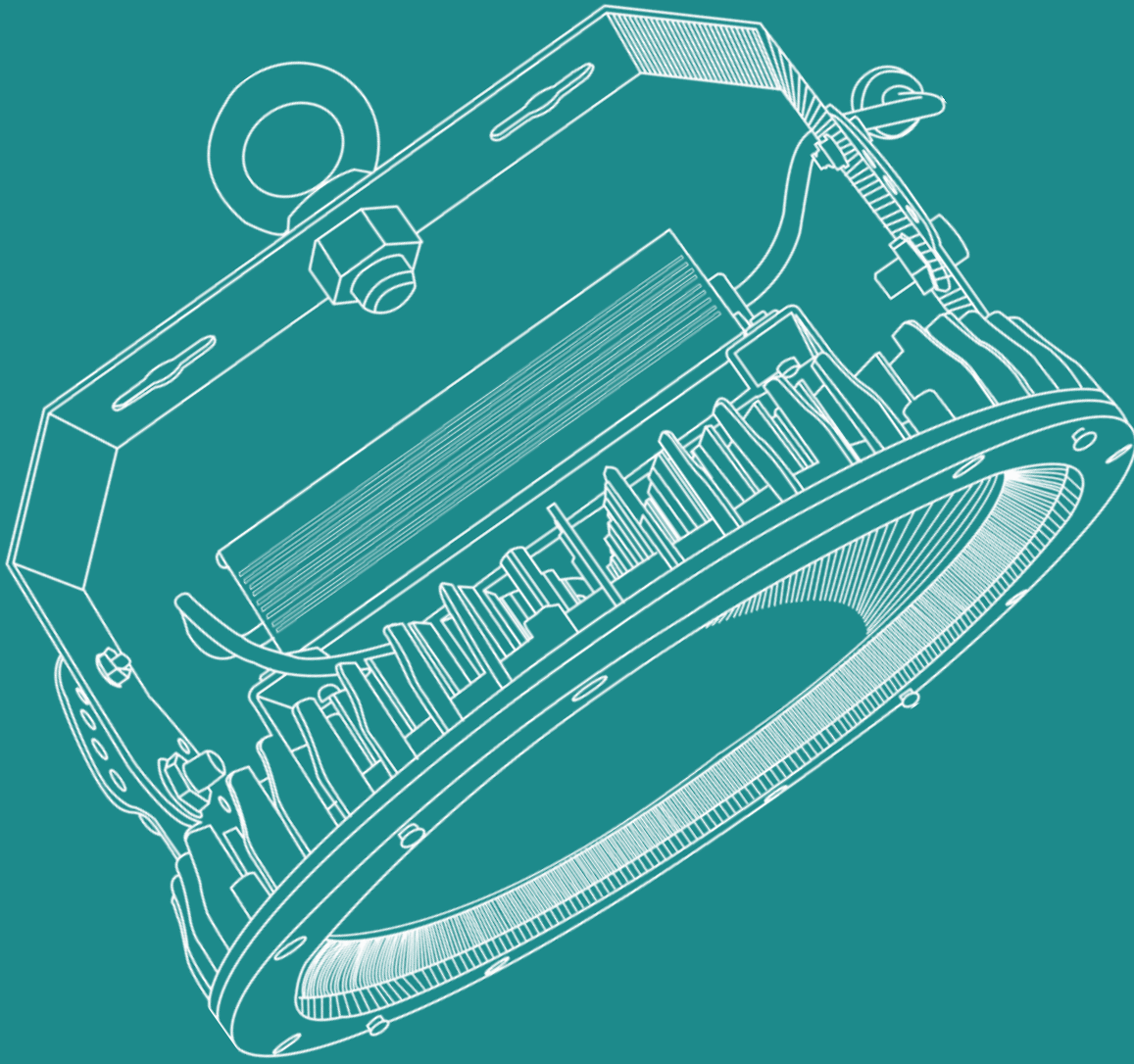

*Different types of industrial spaces have different lighting requirements depending on the space and how it's used. Are you lighting a processing facility with many factory workers that require a high level of light to see? Or are things mostly automated or are you lighting a warehouse where lighting helps workers see where they need to stack pallets?*

*The level of illumination will depend on both the size of the area, the height of the ceiling, and how active the area will be for employees.*

*Haneco has a wealth of experience incorporating the latest technology to provide energy efficient, secure and visually comfortable lighting solutions for a variety of industrial applications.*

# HIGHBAY / LOWBAY

## ■ Highbay



SKYPAD p120



SUPERNOVA p126



HOODIE p127



MERIDIAN p128

## ■ Lowbay



SKYCUBE p131



HIGH BAY









# SKYPAD

## LED Highbay

120

HIGHBAY / LOWBAY



### DESCRIPTION

SKYPAD is a powerful, cost effective and adaptable solution for lighting large industrial spaces. It comes in a range of wattages with accessories including diffusers, wire guards and brackets that allow 90 degree mounting.

### KEY FEATURES

- Robust powder coated aluminium body
- Excellent luminous efficacy
- Complete with flex and plug for simple installation
- Intellisensor motion sensor and Sunmax daylight sensor available
- KASTA bluetooth wireless daylight sensor and 1-10V dimming system available

### APPLICATIONS

Factories

### Standards



POWER	LUMEN	lm/W	CCT	WEIGHT	SAP CODE	PRODUCT CODE
120W	17320 lm	144 lm/W	5000K	4.00 kg	2000881	<b>SKYPAD120W-10VDIM</b>
150W	21000 lm	140 lm/W	5000K	4.00 kg	2000390	<b>SKYPAD150W-10VDIM</b>
200W	28000 lm	140 lm/W	5000K	5.50 kg	2000908	<b>SKYPAD200W-V2</b>

### Dimensions

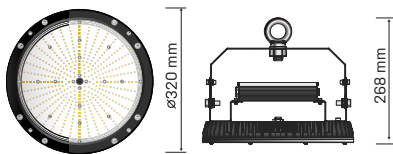

SKYPAD120W-10VDIM / SKYPAD150W-10VDIM

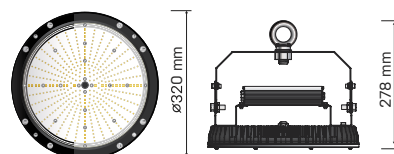

SKYPAD200W-V2

Accessories



SENSOR			
ACCESSORIES	FEATURES	SAP CODE	PRODUCT CODE
INTELLISENSOR Smart Control	Intelligent microwave motion sensor is an ideal way to provide low level comfort lighting when no presence is in the area	2001118	<b>MC031V</b>

INTELLISENSOR Smart Control Application Diagram

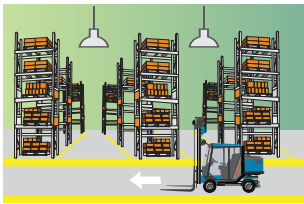

With sufficient ambient light, the sensor does not switch on the lamp.

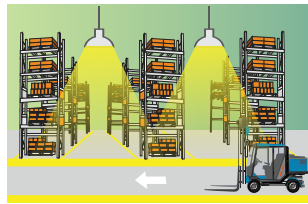

With sufficient ambient light, the sensor switches on the lamp when motion is detected.

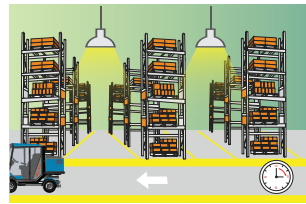

After hold time, the sensor dims the lamp at a low level if no new motion trigger.

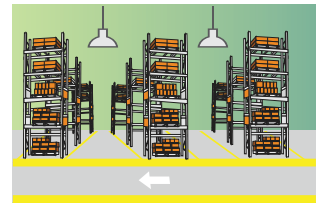

After stand-by period, the sensor switches off the lamp if no motion is detected in its detection zone.



SENSOR			
ACCESSORIES	FEATURES	SAP CODE	PRODUCT CODE
SUNMAX Smart Control	Daylight sensor with smart control. Ideal for daylight harvesting applications	2000878	<b>SUNMAX-50MA-W-IP20</b>
BRACKET	Matt black steel	2000891	<b>SUNMAX-BRKT</b>



SUNMAX Smart Control Application Diagram

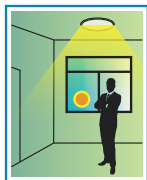

The lamp lights on 100% illumination or dims to maintain the preset illumination level against ambient light.

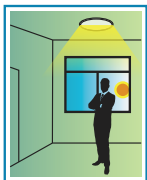
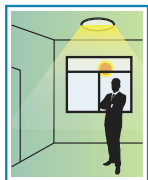

The lamp dims to minimum light level but never turn off even if with sufficient ambient light.



Users can switch off the light manually.



MOUNTING OPTIONS

ACCESSORIES	FEATURES	SAP CODE	PRODUCT CODE
KASTA 1-10V Dimmer	Wireless dimming control perfect for large spaces	5000012	<b>D1-10VIBH</b>

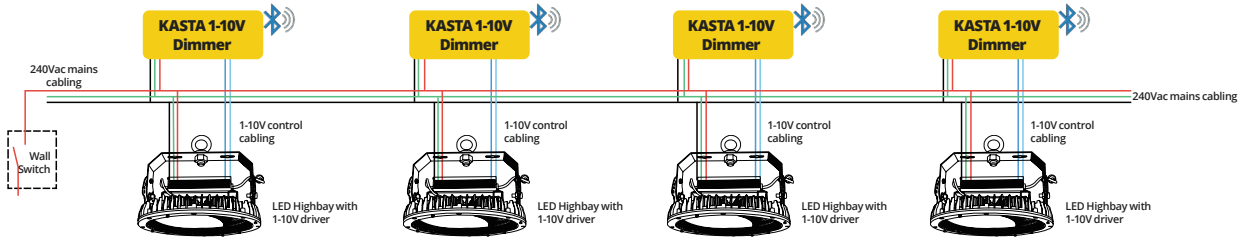

MOUNTING OPTIONS



ACCESSORIES	FEATURES	SAP CODE	PRODUCT CODE
KASTA Daylight Sensor	Used with 1-10V dimmer for day-light harvesting	5000011	<b>SL02AB-BH</b>

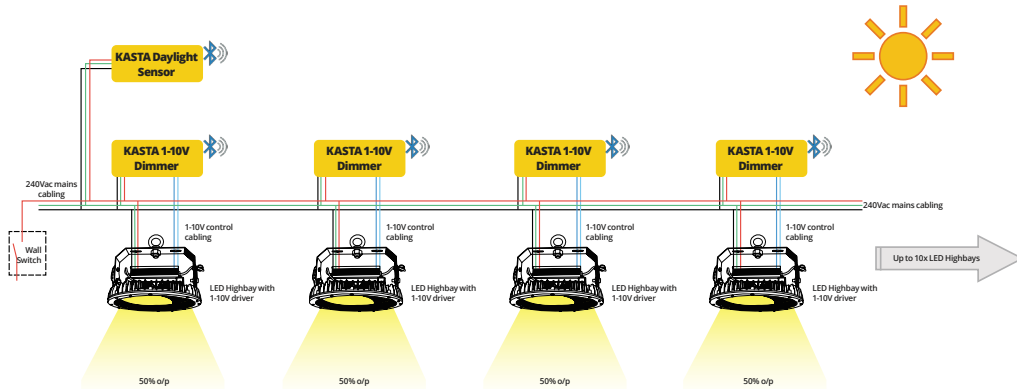

Accessories



MOUNTING OPTIONS

ACCESSORIES	FEATURES	SAP CODE	PRODUCT CODE
Extension Bracket	For different mounting options up to 90°	2000196	<b>FL-SKYPADKIT</b>



MOUNTING OPTIONS

ACCESSORIES	FEATURES	SAP CODE	PRODUCT CODE
Food Safe Surface Mount Kit	Suitable for hospitality and food processing industries	2000395	<b>SKYPAD-FGSMK001</b>



Accessories



REFLECTOR

ACCESSORIES	FEATURES	SAP CODE	PRODUCT CODE
Metal Reflector	Metal reflector for 90° glare control	2000292	<b>HRPAD90DB</b>



REFLECTOR

ACCESSORIES	FEATURES	SAP CODE	PRODUCT CODE
Prismatic Reflector	Tough polycarbonate prismatic diffuser	2000396	<b>SKYPAD-PRSDIF<sup>1</sup></b>
		2000827	<b>SKYPAD-PRSDIF-EN<sup>2</sup></b>

<sup>1</sup>open prismatic reflector    <sup>2</sup>enclosed prismatic reflector

Accessories



DIFFUSER

ACCESSORIES	FEATURES	SAP CODE	PRODUCT CODE
Diffuser	Tough opal polycarbonate diffuser for glare reduction	2000350	<b>PCD-SKYPAD</b>

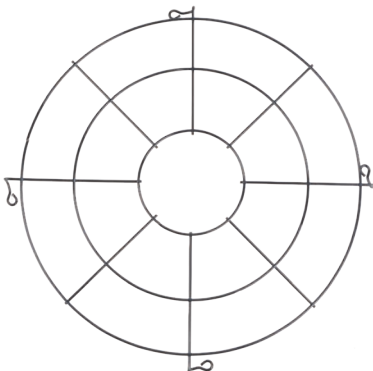

WIREGUARD

ACCESSORIES	FEATURES	SAP CODE	PRODUCT CODE
Wireguard	Extra protection to vandal prone applications	2000399	<b>SKYPAD-WIREGUARD</b>

# SUPERNOVA

## Linear LED Highbay

126

HIGHBAY / LOWBAY



### DESCRIPTION

The SUPERNOVA range features excellent luminous efficacy, compactness, high impact resistance and excellent light distribution.

### KEY FEATURES

- Robust powder coated aluminium body
- Excellent luminous efficacy
- Complete with flex and plug for simple installation
- Compatible with SUNMAX and INTELLISENSOR

### APPLICATIONS

Retails, Factories

### Standards



POWER

LUMEN

lm/W

CCT

WEIGHT

SAP CODE

PRODUCT CODE

80W

10450 lm

131 lm/W

5000K

3.30 kg

2000766

**SN80WS**

### Dimensions

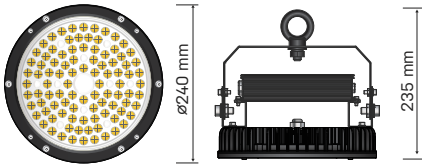

# HOODIE

## LED Highbay with Reflector



### DESCRIPTION

The HOODIE features excellent luminous efficacy, compactness and aesthetically pleasing design which is ideal for large retail complex and industrial applications.

### KEY FEATURES

- Robust powder coated aluminium body
- Excellent luminous efficacy
- Complete with flex and plug for simple installation

### APPLICATIONS

Retails, Factories

### Standards



295MM x 1195MM

POWER	LUMEN	lm/W	CCT	WEIGHT	SAP CODE	PRODUCT CODE
80W	10450 lm	131 lm/W	5000K	5.60 kg	2001240	<b>HOODIE80WS</b>

### Dimensions

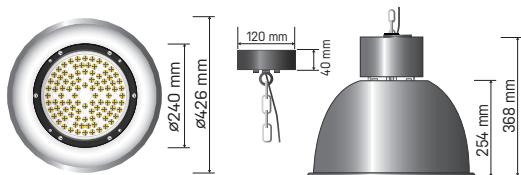



# MERIDIAN

## Linear LED Highbay

128

HIGHBAY / LOWBAY



### DESCRIPTION

The MERIDIAN is a linear LED highbays engineered to provide illumination tall pallet racks in warehouses with minimal light wastage. The MERIDIAN is an ideal highbay for warehouses applications.

### KEY FEATURES

- Engineered to optimize light distribution for warehouse aisles and racks
- Excellent luminous efficacy
- Choice of beam angles for standard heights and high ceilings
- Ceiling or suspension mount

### APPLICATIONS

Factories

### Standards



295MM x 1195MM

POWER	BEAM ANGLE	LUMEN	lm/W	CCT	WEIGHT	SAP CODE	PRODUCT CODE
120W	30°x70° High ceiling	16300 lm	136 lm/W	5000K	5.60 kg	2000990	<b>MERID120W30X70*</b>
120W	40°x130°	16440 lm	137 lm/W	5000K	5.60 kg	2000991	<b>MERID120W40X130*</b>
160W	30°x70° High ceiling	21000 lm	131 lm/W	5000K	8.30 kg	2000992	<b>MERID160W30X70</b>
160W	40°x130°	21000 lm	131 lm/W	5000K	8.30 kg	2000993	<b>MERID160W40X130</b>

\*VEU/IPART/REES approved.

### Dimensions

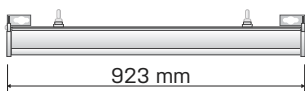

MERID120W

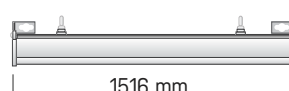
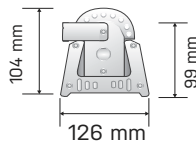

MERID160W

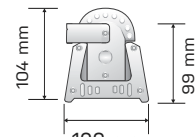

# A GUIDE TO WAREHOUSE LIGHTING

For warehouse lighting the Australian Standards AS/NZ1680.2.4 recommends the following **maintained average** lux levels  
 Storage of goods of different kinds and search and retrieval tasks = **Av 80 lux**  
 Storage routinely involving reading tasks = **Av 160 lux**

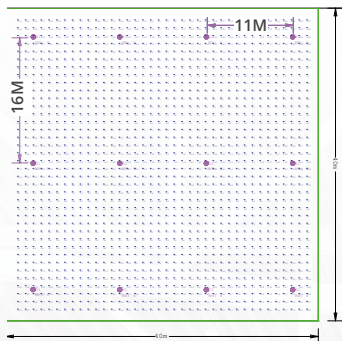

Hm = 6m  
**SKYPAD 120W**  
 AV 92 lux  
 Uf = 0.51  
 Mf = 0.8

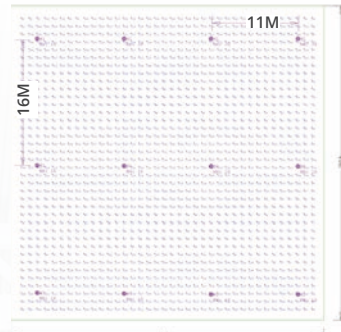

Hm = 10m  
**SKYPAD 150W**  
 AV 102 lux  
 Uf = 0.74  
 Mf = 0.8

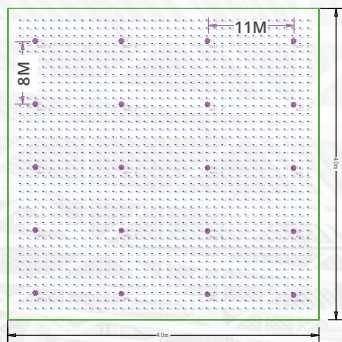

Hm = 6m  
**SKYPAD 120W**  
 AV 160 lux  
 Uf = 0.6  
 Mf = 0.8

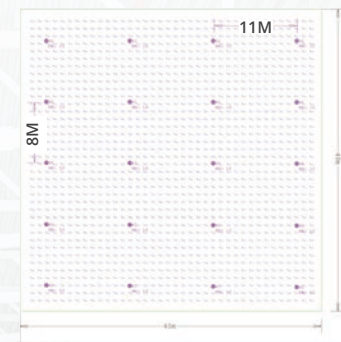

Hm = 10m  
**SKYPAD 150W**  
 AV 178 lux  
 Uf = 0.66  
 Mf = 0.8



7.3M Spacing  
 2M

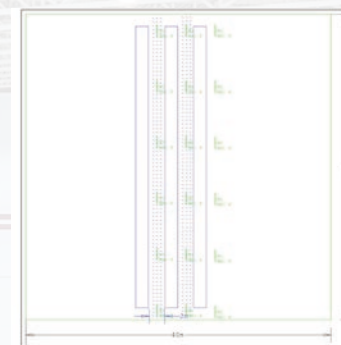

Hm = 10m  
**MERIDIAN 160W**  
 AV 258 lux  
 Uf = 0.5  
 Mf = 0.8

## ADDITIONAL OPTIONS TO CONSIDER

### Sunmax smart control

The installation of a Sunmax that controls light levels depending on daylight can be a convenient option for warehouse lighting. If the warehouse receives natural light in some areas it might be appropriate to reduce the intensity of the lighting in those areas. This would significantly minimize energy costs. Refer p137 for product information.

### Intellisensor smart control

In warehouse spaces where there is no activity, there is no need to keep lights on at all time and a convenient way to keep energy costs down is to utilize motion sensors. Motion sensors serve to coordinate the diffusion of light based on occupancy in various areas of the warehouse. Refer p137 for product information.



LOW BAY

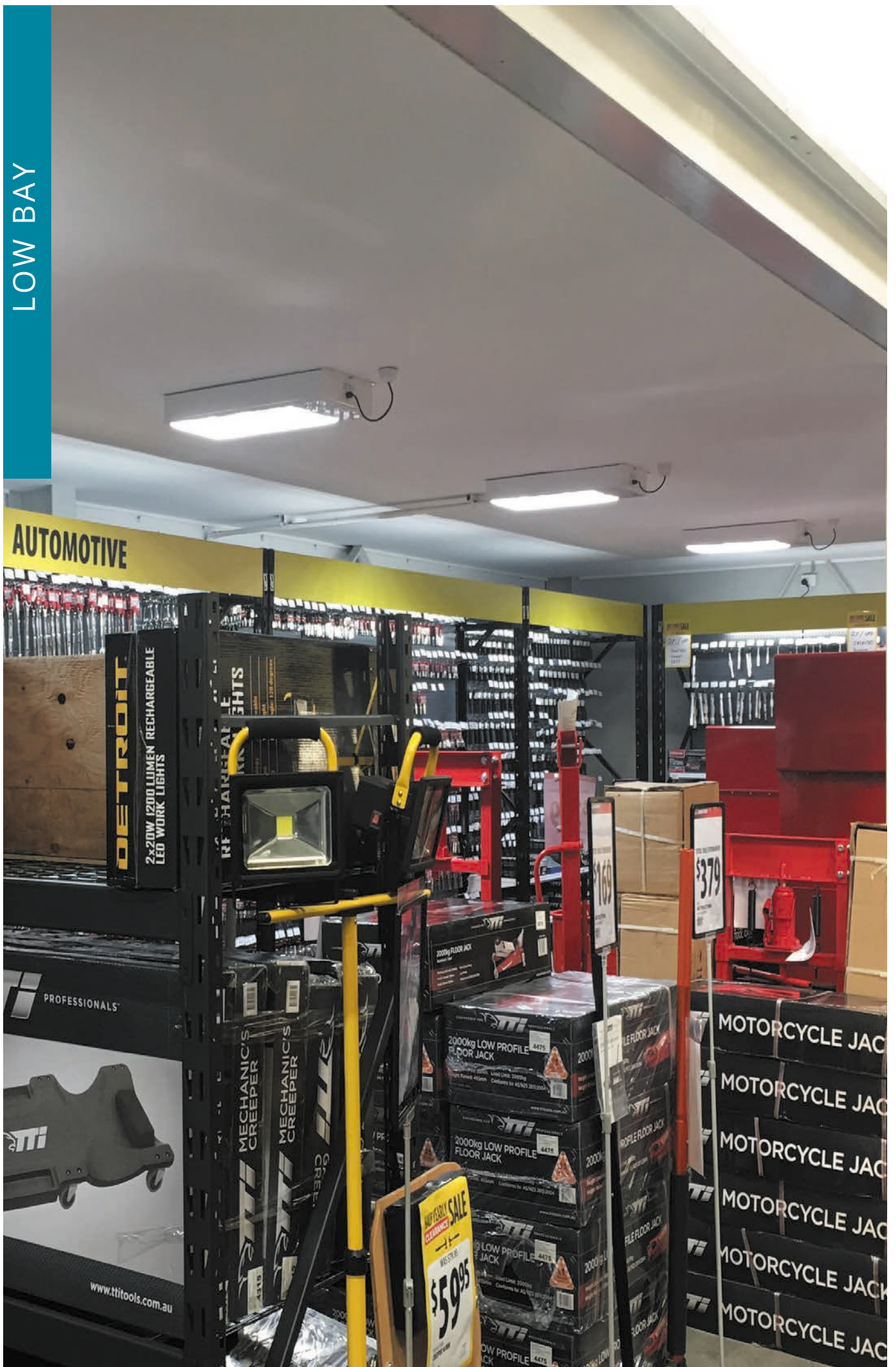

# SKYCUBE

## LED Lowbay



### DESCRIPTION

The SKYCUBE is an economical and energy efficient alternative to high maintenance conventional low bay lighting.

### KEY FEATURES

- Significantly reduces costs compared to metal halide
- Excellent luminous efficacy
- Excellent light distribution
- Surface mount installation

### APPLICATIONS

Retails, Factories, Carpark

Standards



HACCP

### 295MM x 1195MM

POWER	FEATURE	LUMEN	lm/W	CCT	WEIGHT	SAP CODE	PRODUCT CODE
120W	Clear diffuser	12400 lm	103 lm/W	5000K	6.00 kg	2000380	<b>SKYCUBE120W-IP65</b>
180W	Clear diffuser	19190 lm	107 lm/W	5000K	7.90 kg	2000381	<b>SKYCUBE180W</b>
180W	Opal diffuser	18160 lm	101 lm/W	5000K	7.90 kg	2000656	<b>SKYCUBE180W-OP</b>

Dimensions

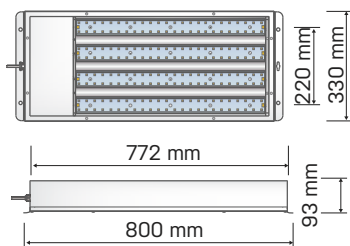





**Tennis Court, QLD**  
completed by **Apex Contracting, QLD**

With HANECO PARX 200W LED floodlight achieved a massive energy saving - combined 4 LED fittings consumed less power than 1 of their old fitting. Advantage was the no-waiting time for lights to turn on or off before and after games.

**Featured Products: PARX**





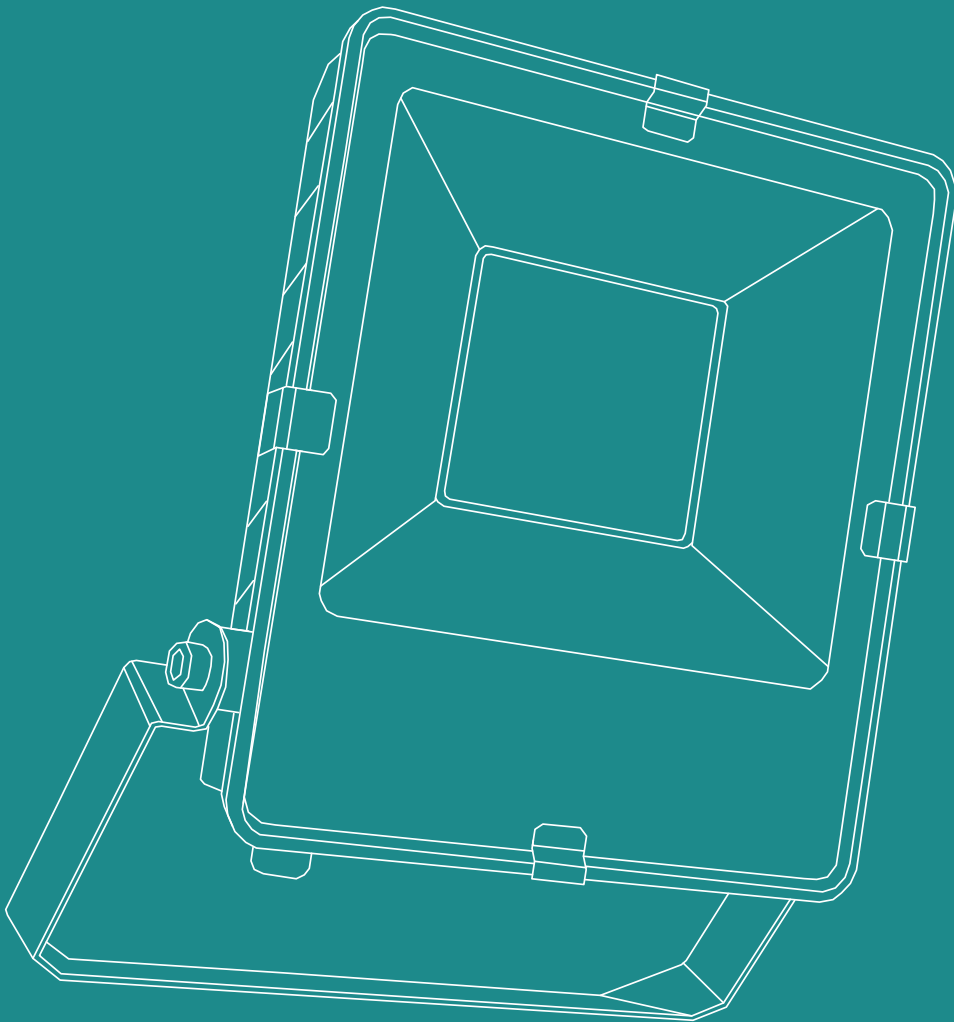

*Over the years Haneco Lighting have supported many clients in the residential and commercial sector on a diverse array of applications. It is down to our tailored approach, experience, support and expertise that our clients come back to us time and time again.*

*Haneco's design team offers compliance lighting designs for exterior applications that will meet Australian standards. Whether its lighting a carpark to Australian standard AS/NZ 1158.3.1 P11 or the control of obtrusive effects of outdoor lighting in accordance to AS/NZ4282:2019*

*We take the time to understand how each space will be used to ensure we achieve the required results.*

# EXTERIOR LIGHTING

## FLOOD LIGHT



STAX p137



PARX p140

## BUNKER



DAWN p144



CALEO p146



PROXIMA p147



ARCHISPOT p148



WALL WASHER p149

## BOLLARD



MATITA p151



FLOODLIGHT

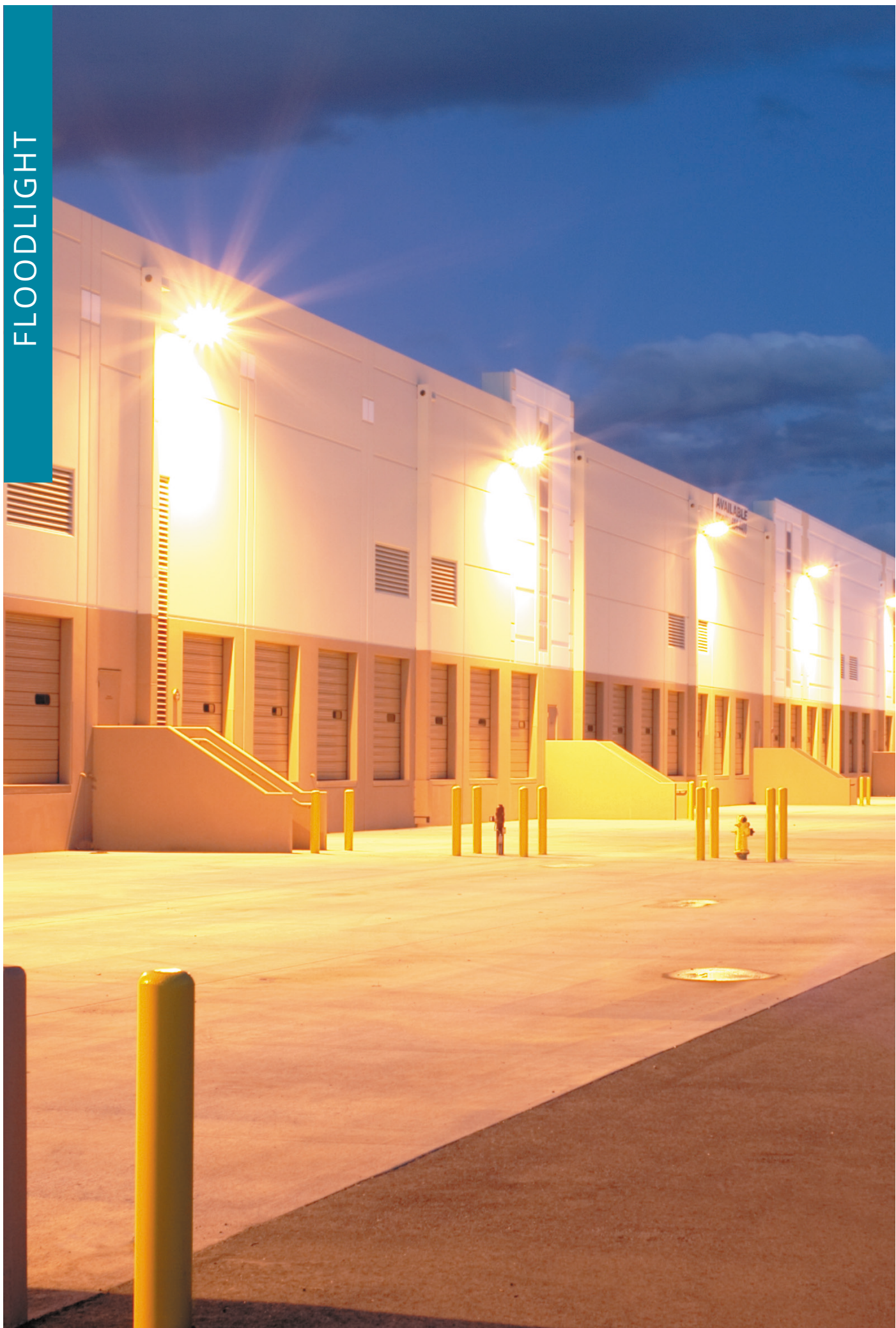

# STAX

## LED Floodlight



### DESCRIPTION

The STAX is a versatile and efficient LED floodlight range from 10W to 180W. PIR motion sensor option is also available in areas where added security is required.

### KEY FEATURES

- Trunnion mount floodlight
- Wall mount & pole mount options
- Available in 10W to 180W
- IP65 weatherproof

### APPLICATIONS

Residential, Schools, Retails, Factories, Public Areas

Standards



STANDARD

POWER	LUMEN	lm/W	CCT	WEIGHT	SAP CODE	PRODUCT CODE
10W	1040 lm	104 lm/W	5000K	0.30 kg	2001647	<b>STAX10WB5K</b>
20W	2070 lm	104 lm/W	5000K	0.50 kg	2001648	<b>STAX20WB5K</b>
30W	3180 lm	106 lm/W	5000K	0.65 kg	2001649	<b>STAX30WB5K</b>
50W	5640 lm	113 lm/W	5000K	1.00 kg	2001650	<b>STAX50WB5K</b>
75W	10450 lm	139 lm/W	5000K	1.90 kg	2001651	<b>STAX75WB5K</b>
100W	13580 lm	136 lm/W	5000K	1.90 kg	2001652	<b>STAX100WB5K</b>
140W	18410 lm	132 lm/W	5000K	2.80 kg	2001653	<b>STAX140WB5K</b>
180W	22840 lm	127 lm/W	5000K	4.90 kg	2001654	<b>STAX180WB5K</b>

Dimensions

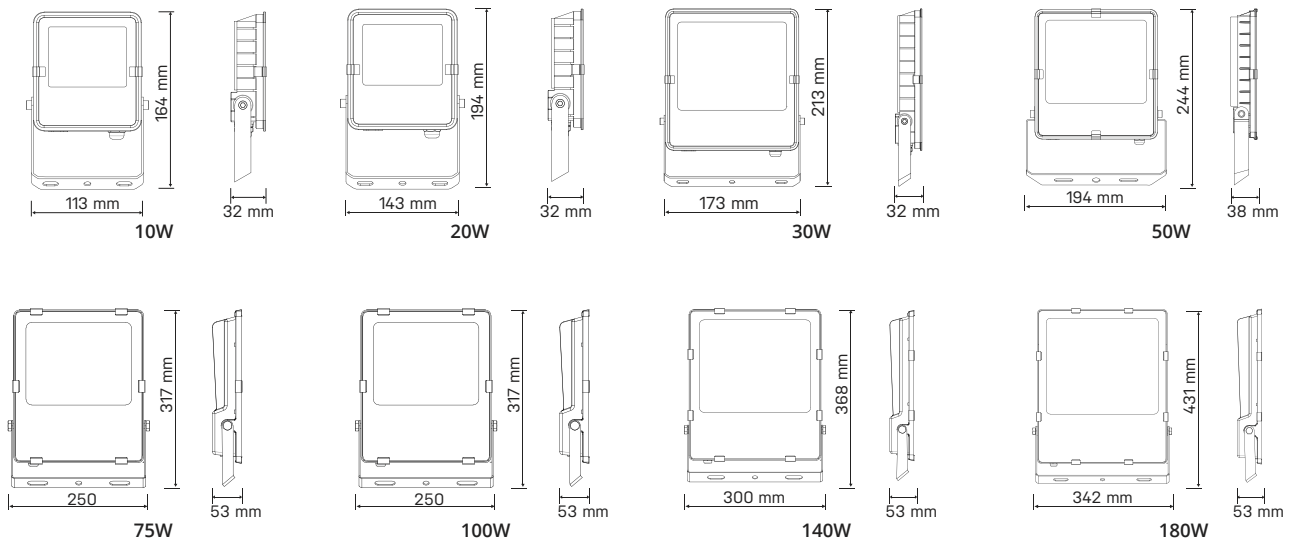

PIR MOTION SENSOR

POWER	LUMEN	lm/W	CCT	WEIGHT	SAP CODE	PRODUCT CODE
10W	1040 lm	104 lm/W	5000K	0.34 kg	2001858	<b>STAX10WB5K-S</b>
20W	2070 lm	104 lm/W	5000K	0.49 kg	2001859	<b>STAX20WB5K-S</b>
30W	3180 lm	106 lm/W	5000K	0.67 kg	2001860	<b>STAX30WB5K-S</b>
50W	5640 lm	113 lm/W	5000K	0.99 kg	2001861	<b>STAX50WB5K-S</b>

Dimensions

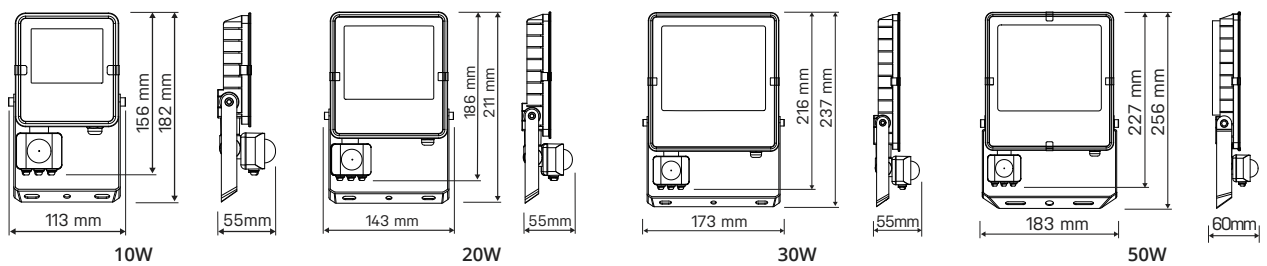

STAX-S WITH SENSOR



# PARX

## 150/200/300 Watt, high powered asymmetric lens LED



### DESCRIPTION

High performance floodlight ideal for minimal spill light applications.

### KEY FEATURES

- Trunnion Mount Floodlight
- Wall mount & Pole mount options
- 150W, 200W, 300W
- 319mm x 411mm x 90mm
- IP65
- Asymmetric distribution
- Perfect for car parks and area lighting

### APPLICATIONS

Carparks, Area Lighting

### Standards



### PIR MOTION SENSOR

POWER	LUMEN	lm/W	CCT	WEIGHT	SAP CODE	PRODUCT CODE
100° x 66° Beam	150 W	20000 lm	133 lm/W	5000K	7.80kg	2000886 <b>PARX150W-ASYM</b>
100° x 66° Beam	200 W	24710 lm	124 lm/W	5000K	7.80kg	2000851 <b>PARX200W-ASYM</b>
120° x 60° Beam	300 W	39280 lm	131 lm/W	5000K	7.80kg	2001092 <b>PARX300W-ASYM</b>

### Dimensions

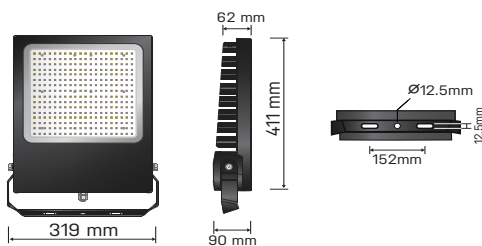

Accessories



**GLARE SHIELD**  
Reduces unwanted glare

SIZE	MATERIAL	PRODUCT CODE
320 x 275 x 120mm	POWDERCOATED STEEL	<b>PARX-GS</b>



**WIRE GUARD**  
Protect lens

SIZE	MATERIAL	PRODUCT CODE
340 x 290 x 60mm	POWDERCOATED STEEL	<b>PARX-WG</b>

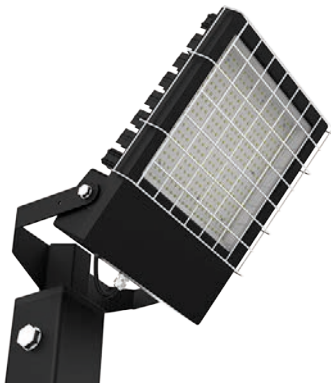

**TENON MOUNT**  
Top mount bracket

SIZE	MATERIAL	PRODUCT CODE
322 x 230 x 96mm	POWDERCOATED STEEL	<b>PARX-TENON</b>



**POLE MOUNT**  
Side mount bracket

SIZE	MATERIAL	PRODUCT CODE
322X205X62mm	POWDERCOATED STEEL	<b>PARX-POLEM</b>



BUNKER









# DAWN

## LED Bunker



### DESCRIPTION

The DAWN is a robust IP66 and IK10 aluminium LED bulkhead with UV stabilized polycarbonate diffuser optimized for LED. It is ideal for outdoor applications such as apartments, schools and public areas.

### KEY FEATURES

- Robust powder coated aluminium body
- Large terminal block for easy installation
- IK10 impact rating
- Lithium Iron Phosphate (LiFePO4) battery emergency version available

### APPLICATIONS

Schools, Offices, Retails, Galleries, Factories, Carparks, Stairwells

### Dimensions



30W ROUND SHAPE



20W ROUND SHAPE



16W OVAL SHAPE

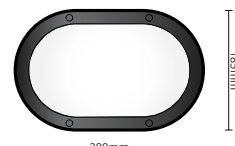

**Standards**



POWER	FEATURE	LUMEN	lm/W	CCT	WEIGHT	SAP CODE	PRODUCT CODE		
16W	Opal diffuser Oval	1320 lm	83 lm/W	3000K	0.95 kg	2001706	<b>DN16WOVL-TRI</b>		
		1500 lm	94 lm/W	4000K					
		1400 lm	88 lm/W	5000K					
		-	-	1320 lm	83 lm/W	3000K	1.40 kg	-	<b>DN16WOVL-TRI-EM</b>
				1500 lm	94 lm/W	4000K			
				1400 lm	88 lm/W	5000K			
20W	Opal diffuser Round	2050 lm	103 lm/W	3000K	1.30 kg	2001699	<b>DN20WRND-TRI</b>		
		2050 lm	103 lm/W	4000K					
		1890 lm	95 lm/W	5000K					
		-	-	2050 lm	103 lm/W	3000K	1.80 kg	-	<b>DN20WRND-TRI-EM</b>
				2050 lm	103 lm/W	4000K			
				1890 lm	95 lm/W	5000K			
30W	Opal diffuser Round	2760 lm	92 lm/W	3000K	2.30 kg	2001700	<b>DN30WRND-TRI</b>		
		3000 lm	100 lm/W	4000K					
		2770 lm	92 lm/W	5000K					
		-	-	2760 lm	92 lm/W	3000K	2.80 kg	-	<b>DN30WRND-TRI-EM</b>
				3000 lm	100 lm/W	4000K			
				2770 lm	92 lm/W	5000K			

ACCESSORIES	FEATURES	SAP CODE	PRODUCT CODE
Round eyelid	270mm trim	2001701	<b>DNRND-EL270</b>
Oval grille	280 x 185mm trim	2001709	<b>DNOVL-GR280</b>

**Accessories**



**ROUND EYELID**  
(20W Only)



**OVAL GRILLE**  
(16W Only)



**DAWN 16W**

# CALEO

## Wall Mounted Security LED Luminaire



### DESCRIPTION

CALEO is a vandal resistant, practical and sturdy outdoor luminaire. It is ideal for pathways and security light.

### KEY FEATURES

- Robust powder coated aluminium body
- Large terminal block for easy installation
- Motion sensor and daylight sensor version available

### APPLICATIONS

Schools, Stairwells, Public Areas

### Standards



POWER	FEATURE	LUMEN	lm/W	CCT	WEIGHT	SAP CODE	PRODUCT CODE
30W		2290 lm	76 lm/W	5000K	2.15 kg	2000697	<b>CALEO30W-5K</b>
30W	Microwave motion sensor	2290 lm	76 lm/W	5000K	2.15 kg	2000698	<b>CALEO30W-5K-S</b>

### Dimensions

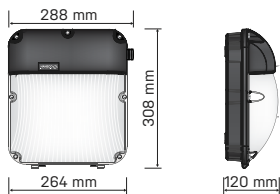

# PROXIMA

## Security Light



### DESCRIPTION

The PROXIMA is an ideal luminaire for general security illumination. The small profile design with PIR sensor is ideal for residential and commercial exterior applications such as entrance, driveways and carports.

### KEY FEATURES

- Large terminal block for easy installation
- Single or twin head with PIR motion sensor available
- IP54 weather resistance

### APPLICATIONS

Schools, Stairwells, Public Areas

### Standards



POWER	FEATURE	LUMEN	lm/W	CCT	WEIGHT	SAP CODE	PRODUCT CODE
10W	-	710 lm	71 lm/W	5000K	0.37 kg	2001590	<b>PROXIMA10W1P-B5K</b>
10W	PIR motion sensor	710 lm	71 lm/W	5000K	0.48 kg	2001112	<b>PROXIMA10W1P-B5K-S</b>
20W	-	1370 lm	69 lm/W	5000K	0.57 kg	2001591	<b>PROXIMA20W2P-B5K</b>
20W	PIR motion sensor	1370 lm	69 lm/W	5000K	0.68 kg	2001113	<b>PROXIMA20W2P-B5K-S</b>

### Dimensions

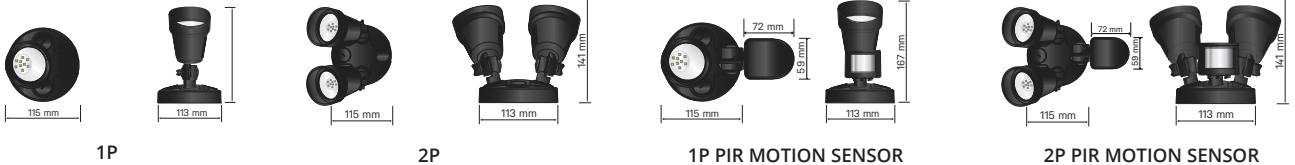



# ARCHISPOT

## LED Exterior Light



### DESCRIPTION

ARCHISPOT is wall pillar luminaire with replaceable GU10 LED lamps to provide accent lighting for residential, retail and commercial areas.

### KEY FEATURES

- Robust powder coated aluminium body
- Large terminal block for easy installation
- IP65 weatherproof
- Available in fixed, adjustable or up/down configurations
- Available in black or silver finish

### APPLICATIONS

Residential, Schools, Retail, Public Areas

### Standards



POWER	FEATURE	LUMEN	lm/W	CCT	WEIGHT	SAP CODE	PRODUCT CODE
6W	Fixed Black	420 lm	70 lm/W	3000K	0.40 kg	2001817	<b>ASFIX6W60-B-3K</b>
6W	Fixed Silver	420 lm	70 lm/W	3000K	0.40 kg	2001477	<b>ASFIX6W60-S-3K</b>
6W	Adjust Black	420 lm	70 lm/W	3000K	0.40 kg	2001818	<b>ASADJ6W60-B-3K</b>
6W	Adjust Silver	420 lm	70 lm/W	3000K	0.40 kg	2001478	<b>ASADJ6W60-S-3K</b>
12W	Up/Down Black	930 lm	78 lm/W	3000K	0.65 kg	2001538	<b>ASU/D12W60-B-3K</b>
12W	Up/Down Silver	930 lm	78 lm/W	3000K	0.65 kg	2001479	<b>ASU/D12W60-S-3K</b>

### Dimensions

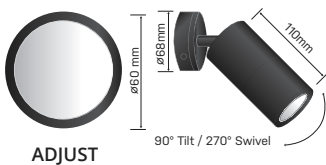

ADJUST

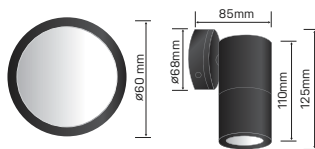

Fixed

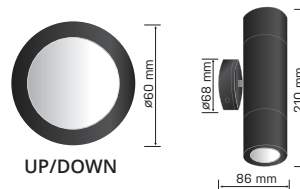

UP/DOWN



ADJUST SILVER



FIXED

# WALL WASHER

## LED Wall Washer



### DESCRIPTION

WALL WASHER an ideal accent lighting luminaire with excellent optical control to avoid excess light spillage for interior and exterior applications.

### KEY FEATURES

- Robust powder coated aluminium body
- Large terminal block for easy installation
- IP54 weatherproof
- Available in black, grey or white finish

### APPLICATIONS

Residential, Schools, Retails, Public Areas

Standards



POWER	FEATURE	LUMEN	lm/W	CCT	WEIGHT	SAP CODE	PRODUCT CODE
12W	Black	430 lm	36 lm/W	3000K	0.80 kg	2000549	<b>W12W150*90RE3KB</b>
12W	Grey	430 lm	36 lm/W	3000K	0.80 kg	2000550	<b>W12W150*90RE3KG</b>
12W	White	430 lm	36 lm/W	3000K	0.80 kg	2000551	<b>W12W150*90RE3KW</b>
12W	Black	460 lm	4000K	0.80 kg	2000552	<b>W12W150*90RE4KB</b>	
12W	White	460 lm	38 lm/W	4000K	0.80 kg	2000553	<b>W12W150*90RE4KW</b>
12W	Black	420 lm	35 lm/W	6000K	0.80 kg	2000554	<b>W12W150*90RE6KB</b>
12W	White	420 lm	35 lm/W	6000K	0.80 kg	2000555	<b>W12W150*90RE6KW</b>

Dimensions

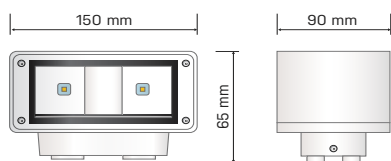

GREY



BLACK

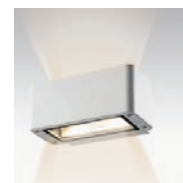



BOLLARD





# MATITA

## LED Bollard



### DESCRIPTION

MATITA bollards guide the way with a low glare louvered light.

### KEY FEATURES

- Ideal for landscape applications
- Matte black powdercoated corrosion resistant finish
- Louvered optics to minimize glare

### APPLICATIONS

Residential, Exterior

### Standards



WATT	LUMEN	lm/W	TRIM	CCT	WEIGHT	SAP CODE	PRODUCT CODE
12W	780 lm	65 lm/W	BLACK	3000K	3.00 kg	2000542	<b>G12W120*650R3K52DC-BK</b>

### Dimensions

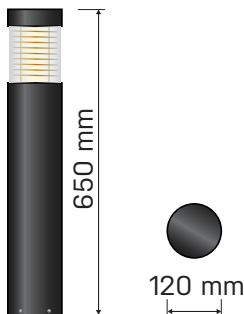



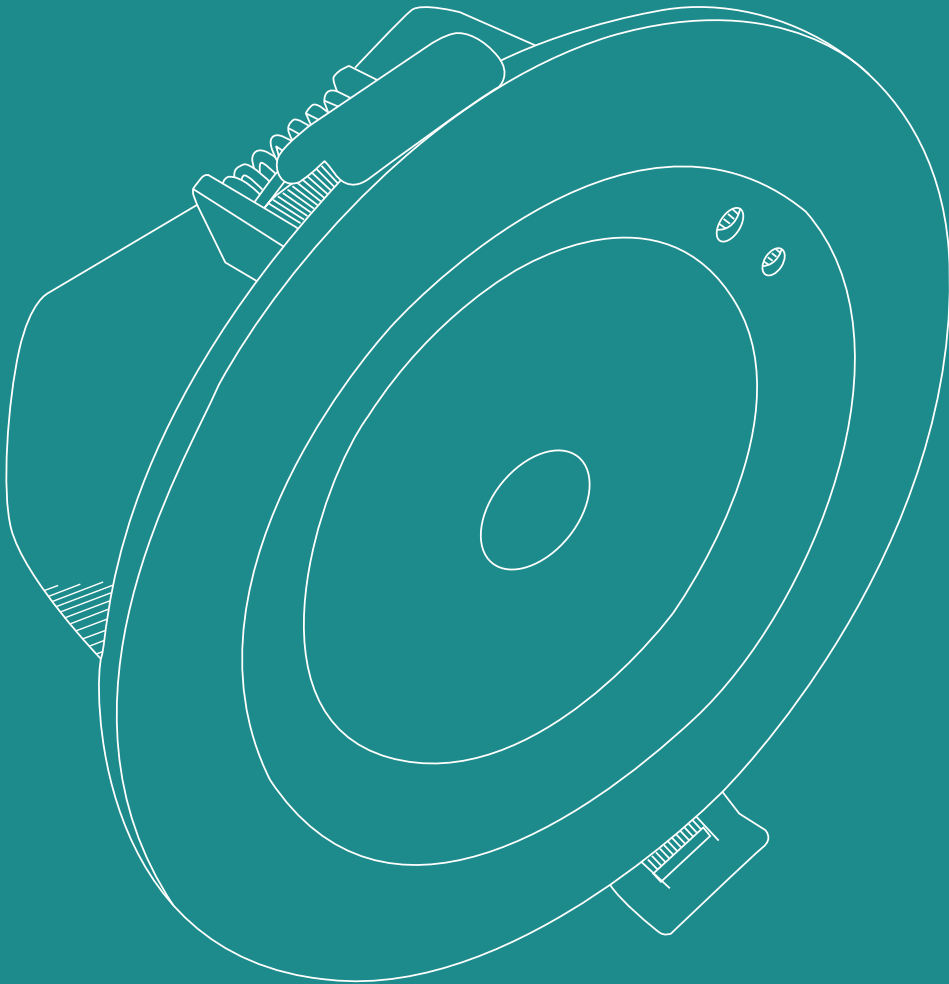

*Haneco's wide range of battens, linear and surface mounted fittings cater for everything from residential, office, Commercial and carpark applications.*

*To complement this range there is an extensive choice of lithium certified Emergency fittings available for your project.*

# EMERGENCY LIGHTING

## EMERGENCY LIGHT



LUME p156

## EMERGENCY BATTEN



VISTA p158



VISTALITE p160



DURALITE p161



TRIPROOF p162

## EMERGENCY CIRCULAR



PURO p164



PLUTO p165

## EMERGENCY WALL LIGHT



DAWN p166

## EMERGENCY KIT



40W LITHIUM  
BATTERY p109



EMERGENCY LIGHTING









# LUME

## Emergency Light



### DESCRIPTION

The LUME is a reliable, lithium powered LED emergency luminaire with integral control gear and battery design for simple installation. Available in D32 or D63 emergency classification, recessed or surface mounting ideal for any commercial applications where emergency lighting is required.

### KEY FEATURES

- AS/NZS 2293.3 compliant
- Available in D32 or D63 emergency classification
- Complete with 140mm adaptor plate for retrofitting
- Complete with flex and plug for simple installation
- Surface mount option available
- Black version available
- Optional rod or chain suspension kit
- Lithium Iron Phosphate (LiFePO4) battery technology

### APPLICATIONS

Schools, Offices, Retail, Galleries, Factories, Carparks, Stairwells

**Dimensions**

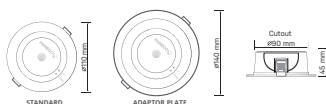

D32 DIMENSION



D63 DIMENSION



D63 SURFACE MOUNT KIT

standards



RECESSED MOUNT

FEATURE	STANDBY POWER	CLASSIFICATION	CCT	WEIGHT	SAP CODE	PRODUCT CODE
Recessed White	0.6W	D32	5700K	0.30 kg	2001059	<b>LUME1W110EM2HR</b>
	0.5W	D63	5700K	0.70 kg	2001853	<b>LUME3WD63</b>
Recessed Black	0.5W	D63	5700K	0.70 kg	2001872	<b>LUME3WD63-BK</b>

SURFACE MOUNT

FEATURE	STANDBY POWER	CLASSIFICATION	CCT	WEIGHT	SAP CODE	PRODUCT CODE
Surface mount White	0.5W	D63	5700K	0.80 kg	2001869	<b>LUME3WD63-SM</b>
Surface mount Black	0.5W	D63	5700K	0.80 kg	2001873	<b>LUME3WD63-SM-BK</b>

ACCESSORIES	DIMENSIONS	SAP CODE	PRODUCT CODE
Surface mount kit	Ø165mm x105mm(H)	2001870	<b>SM-ENC-DL</b>
Suspension kit	-	2001871	<b>SM-ENC-SUSKIT</b>



ADAPTOR RING

# VISTA

## Emergency LED Batten



### DESCRIPTION

The perfect LED replacement for conventional battens, VISTA offers efficiency with excellent light distributions. Intellisensor motion sensor with corridor function and dual power selection further enhance energy savings and Lithium Iron Phosphate (LiFePO4) battery version is available where emergency lighting is required.

### KEY FEATURES

- Selectable colour temperature - 4000K, 4700K and 5700K
- Dual power selection available in 1200mm length only
- Quick and easy installation
- Intellisensor motion sensor with corridor function available
- Lithium Iron Phosphate (LiFePO4) battery emergency version available

### APPLICATIONS

Residential, Schools, Offices, Retails, Factories, Carpark, Stairwells

### Dimensions

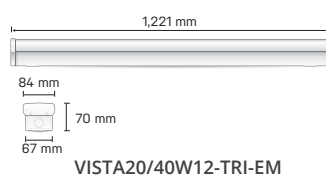

standards



NOMINAL LENGTH 615MM

STANDARD MODE				LOW POWER MODE				EMERGENCY SPECIFICATION				
FEATURE	POWER	LUMEN	lm/W	POWER	LUMEN	lm/W	CCT	WEIGHT	EMERGENCY CLASSIFICATION	BATTERY TYPE	SAP CODE	PRODUCT CODE
Emergency	20W	2000 lm	100 lm/W	-	-	-	4000K	2.00 kg	C0=D50, C90=D32	LiFePO4	2001158	<b>VISTA20W06-TRI-EM</b>
		2200 lm	110 lm/W				4700K					
		2100 lm	105 lm/W				5700K					

NOMINAL LENGTH 1221MM

STANDARD MODE				LOW POWER MODE				EMERGENCY SPECIFICATION				
FEATURE	POWER	LUMEN	lm/W	POWER	LUMEN	lm/W	CCT	WEIGHT	EMERGENCY CLASSIFICATION	BATTERY TYPE	SAP CODE	PRODUCT CODE
Emergency	40W	4540 lm	114 lm/W	20W	2510 lm	126 lm/W	4000K	2.10 kg	C0=D50, C90=D32	LiFePO4	2001063	<b>VISTA20/40W 12-TRI-EM</b>
		4880 lm	122 lm/W				4700K					
		4470 lm	112 lm/W				5700K					
Intellisensor Emergency	40W	4540 lm	114 lm/W	N/A	N/A	N/A	4000K	2.10 kg	C0=D50, C90=D32	LiFePO4	2001065	<b>VISTA40W12-TRI-SS-EM</b>
		4880 lm	122 lm/W				4700K					
		4470 lm	112 lm/W				5700K					

Refer **p88** for standard versions or **p182** for intellisensor versions.



# VISTALITE

## Narrow Body Emergency LED Batten

160

EMERGENCY LIGHTING



### DESCRIPTION

The VISTALITE is a sleek narrow body batten designed as an ideal solution for new installation or replacing single fluorescent battens where lower cost option is required but without compromising on features.

### KEY FEATURES

- Selectable colour temperature - 4000K, 4700K and 5700K
- Dual power selection available in 1200mm length only
- Insect resistant LED module
- Quick and easy installation
- Intellisensor motion sensor with corridor function available
- Lithium Iron Phosphate (LiFePO4) battery emergency

### APPLICATIONS

Residential, Schools, Offices, Retail, Factories, Carpark, Stairwells

Standards



#### NOMINAL LENGTH 615MM

STANDARD MODE				LOW POWER MODE			EMERGENCY SPECIFICATION					
FEATURE	POWER	LUMEN	lm/W	POWER	LUMEN	lm/W	CCT	WEIGHT	EMERGENCY CLASSIFICATION	BATTERY TYPE	SAP CODE	PRODUCT CODE
Emergency	20W	2150 lm	108 lm/W	N/A	N/A	N/A	4000K	1.10 kg	C0=D50 C90=D32	LiFePO4	2001631	<b>VSL20W06-TRI-EM</b>
		2250 lm	113 lm/W				4700K					
		2130 lm	107 lm/W				5700K					

#### NOMINAL LENGTH 1205MM

STANDARD MODE				LOW POWER MODE			EMERGENCY SPECIFICATION					
FEATURE	POWER	LUMEN	lm/W	POWER	LUMEN	lm/W	CCT	WEIGHT	EMERGENCY CLASSIFICATION	BATTERY TYPE	SAP CODE	PRODUCT CODE
Emergency	40W	4220 lm	106 lm/W	20W	2330 lm	117 lm/W	4000K	2.00 kg	C0=D50 C90=D32	LiFePO4	2001635	<b>VSL20W40W12-TRI-EM</b>
		4540 lm	114 lm/W				4700K					
		4610 lm	115 lm/W				5700K					

Dimensions

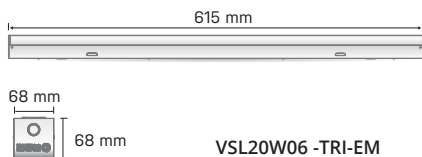

VSL20W06-TRI-EM

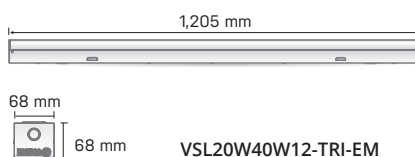

VSL20W40W12-TRI-EM

Refer **p86** for standard versions

# DURALITE

## Narrow Body Emergency Weatherproof LED Batten



### DESCRIPTION

The DURALITE is a sleek narrow body weather resistant batten designed as an ideal solution for new installation or replacing single fluorescent battens where lower cost option is required but without compromising on features.

### KEY FEATURES

- Selectable colour temperature - 4000K and 5000K
- Dual power selection available in 1200mm length only
- Quick and easy installation
- Intellisensor motion sensor with corridor function available
- Lithium Iron Phosphate (LiFePO4) battery emergency

### APPLICATIONS

Residential, Schools, Factories, Carpark, Stairwells, Public Areas

Standards



#### NOMINAL LENGTH 655MM

#### STANDARD MODE

#### LOW POWER MODE

#### EMERGENCY SPECIFICATION

FEATURE	POWER	LUMEN	lm/W	POWER	LUMEN	lm/W	CCT	WEIGHT	EMERGENCY CLASSIFICATION	BATTERY TYPE	SAP CODE	PRODUCT CODE
Emergency	20W	2090 lm 2070 lm	105 lm/W 104 lm/W	-	-	-	4000K 5000K	1.30 kg	C0=D50 C90=D32	LiFePO4	2001497	<b>DURALITE 20W06-EM</b>

#### NOMINAL LENGTH 1220MM

#### STANDARD MODE

#### LOW POWER MODE

#### EMERGENCY SPECIFICATION

FEATURE	POWER	LUMEN	lm/W	POWER	LUMEN	lm/W	CCT	WEIGHT	EMERGENCY CLASSIFICATION	BATTERY TYPE	SAP CODE	PRODUCT CODE
Emergency	36W	4160 lm 4150 lm	116 lm/W 115 lm/W	18W	2720 lm 2680 lm	151 lm/W 149 lm/W	4000K 5000K	2.40 kg	C0=D80 C90=D50	LiFePO4	2001499	<b>DURALITE 18/36W12-EM</b>

Dimensions

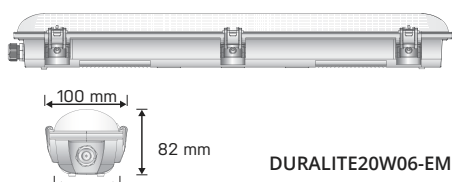

DURALITE20W06-EM

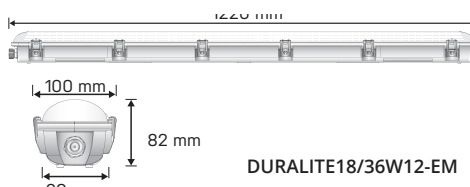

DURALITE18/36W12-EM

Refer **p96** for standard versions

# TRIPROOF

## Emergency Weatherproof LED Batten



### DESCRIPTION

The perfect LED replacement for conventional weather resistant battens, the robust TRIPROOF offers IP65 weather resistant and IK08 impact rating. Intellisensor motion sensor with corridor function and dual power selection further enhance energy savings and Lithium Iron Phosphate (LiFePO4) battery version is available where emergency lighting is required.

### KEY FEATURES

- Selectable colour temperature - 4000K, 5000K and 6500K
- Dual power selection
- Quick and easy installation
- Intellisensor motion sensor with corridor function available
- Lithium Iron Phosphate (LiFePO4) battery emergency

### APPLICATIONS

Residential, Schools, Factories, Carpark, Stairwells, Public Areas

**Dimensions**

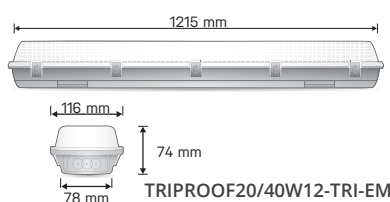
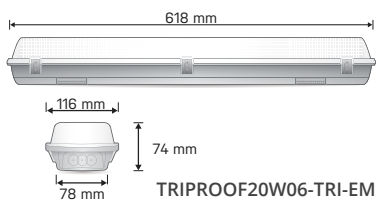

standards



EMERGENCY LIGHTING

NOMINAL LENGTH 618MM

STANDARD MODE				LOW POWER MODE				EMERGENCY SPECIFICATION				
FEATURE	POWER	LUMEN	lm/W	POWER	LUMEN	lm/W	CCT	WEIGHT	EMERGENCY CLASSIFICATION	BATTERY TYPE	SAP CODE	PRODUCT CODE
Emergency	20W	1850 lm	93 lm/W	-	-	-	4000K	2.20 kg	C0=D50, C90=D32	LiFePO4	2001165	<b>TRIPROOF 20W06-TRI-EM</b>
		1990 lm	100 lm/W				5000K					
		1850 lm	93 lm/W				6500K					

NOMINAL LENGTH 1215MM

STANDARD MODEL				LOW POWER MODEL				EMERGENCY SPECIFICATION				
FEATURE	POWER	LUMEN	lm/W	POWER	LUMEN	lm/W	CCT	WEIGHT	EMERGENCY CLASSIFICATION	BATTERY TYPE	SAP CODE	PRODUCT CODE
Emergency	40W	4090 lm	102 lm/W	20W	2230 lm	112 lm/W	4000K	2.20 kg	C0=D50, C90=D32	LiFePO4	2001066	<b>TRIPROOF 20/40W12-TRI-EM</b>
		4410 lm	110 lm/W				5000K					
		4050 lm	101 lm/W				6500K					
Intellisensor Emergency	40W	4090 lm	102 lm/W	20W	2230 lm	112 lm/W	4000K	2.20 kg	C0=D50, C90=D32	LiFePO4	2001068	<b>TRIPROOF 40W12-TRI-SS-EM</b>
		4410 lm	110 lm/W				5000K					
		4050 lm	101 lm/W				6500K					
Emergency	60W	5600 lm	93 lm/W	-	-	-	4000K	3.70 kg	C0=D50, C90=D32	LiFePO4	2001171	<b>TRIPROOF 60W15-TRI-EM</b>
		6000 lm	100 lm/W				5000K					
		5700 lm	95 lm/W				6500K					

Refer **p98** for standard versions or **p183** for intellisensor versions.



# PURO 400

## Tritone Emergency LED Oyster

164

EMERGENCY LIGHTING



### DESCRIPTION

The PURO is an ideal oyster light that is ideal for residential applications. The opal acrylic diffuser provides even light distribution to the space and large terminal block for easy installation.

### KEY FEATURES

- Selectable colour temperature - 3000K, 4200K and 5700K
- Opal acrylic diffuser
- Optional dimmable driver

### APPLICATIONS

Residential

### Standards



### EMERGENCY SPECIFICATION

FEATURE	LUMEN	lm/W	CCT	EMERGENCY CLASSIFICATION	BATTERY TYPE	WEIGHT	SAP CODE	PRODUCT CODE
Tritone Emergency	1690 lm	68 lm/W	3000K	C0=D32, C90=D32	LiFePO4	1.20 kg	2000113	<b>CL25W400R-MULTI-EM</b>
	1840 lm	74 lm/W	2400K					
	1800 lm	72 lm/W	5700K					
Tritone Intellisensor Emergency	1690 lm	68 lm/W	3000K	C0=D32, C90=D32	LiFePO4	1.20 kg	2000110	<b>CL25W400R-MUL-EM-SS</b>
	1840 lm	74 lm/W	2400K					
	1800 lm	72 lm/W	5700K					

### Dimensions

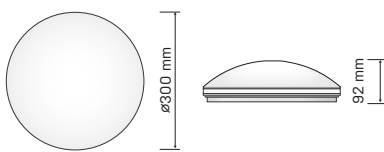

PURO 400 Multi

Refer **p52** for standard versions or **p180** for intellisensor versions.

# PLUTO

## Weatherproof Emergency LED Oyster



### DESCRIPTION

The PLUTO is an ideal oyster light that is ideal for residential and commercial applications. The opal acrylic diffuser provides even light distribution to the space and large terminal block for easy installation.

### KEY FEATURES

- Selectable colour temperature - 3000K, 4200K and 5700K
- Opal acrylic diffuser
- IP54 insect resistant design
- Intellisensor with corridor function available

### APPLICATIONS

Residential, Schools, Offices, Stairwells

### Standards



### EMERGENCY SPECIFICATION

POWER	FEATURE	LUMEN	lm/W	CCT	EMERGENCY CLASSIFICATION	BATTERY TYPE	WEIGHT	SAP CODE	PRODUCT CODE
25W	Tritone Emergency	1690 lm	68 lm/W	3000K	C0=D32, C90=D32	LiFePO4	1.50 kg	2000117	<b>CL25W-400WP-MUL-EM</b>
		1840 lm	74 lm/W	2400K					
		1800 lm	72 lm/W	5700K					
25W	Tritone Intellisensor Emergency"	1690 lm	68 lm/W	3000K	C0=D32, C90=D32	LiFePO4	1.50 kg	2000118	<b>CL25W400WP-MUL-EM-SS</b>
		1840 lm	74 lm/W	2400K					
		1800 lm	72 lm/W	5700K					

### Dimensions

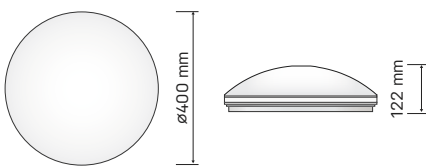

PLUTO 400 Multi

Refer **p54** for standard versions or **p181** for intellisensor versions.

# DAWN

## Emergency LED Bunker



### DESCRIPTION

The DAWN is a robust IP66 and IK10 aluminium LED bulkhead with UV stabilized polycarbonate diffuser optimized for LED. It is ideal for outdoor applications such as apartments, schools and public areas.

### KEY FEATURES

- Robust powder coated aluminium body
- Large terminal block for easy installation
- IK10 impact rating
- Lithium Iron Phosphate (LiFePO4) battery emergency version available

### APPLICATIONS

Schools, Offices, Retails, Galleries, Factories, Carparks, Stairwells

### Dimensions



30W ROUND SHAPE



20W ROUND SHAPE

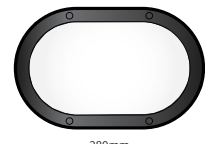
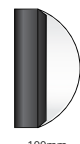

16W OVAL SHAPE

**Standards**



POWER	FEATURE	LUMEN	lm/W	CCT	WEIGHT	SAP CODE	PRODUCT CODE
16W		1320 lm	83 lm/W	3000K	1.40 kg	-	DN16WOVL-TRI-EM
		1500 lm	94 lm/W	4000K			
		1400 lm	88 lm/W	5000K			
20W		2050 lm	103 lm/W	3000K	1.80 kg	-	DN20WRND-TRI-EM
		2050 lm	103 lm/W	4000K			
		1890 lm	95 lm/W	5000K			
30W		2760 lm	92 lm/W	3000K	2.80 kg	-	DN30WRND-TRI-EM
		3000 lm	100 lm/W	4000K			
		2770 lm	92 lm/W	5000K			

ACCESSORIES	FEATURES	SAP CODE	PRODUCT CODE
Round eyelid	270mm trim	2001701	DNRND-EL270
Oval grille	280x185mm trim	2001709	DNOVL-GR280

**Accessories**



ROUND EYELID  
(20W Only)



OVAL GRILLE  
(16W Only)



DAWN 16W

Refer **p144** for standard verisons .



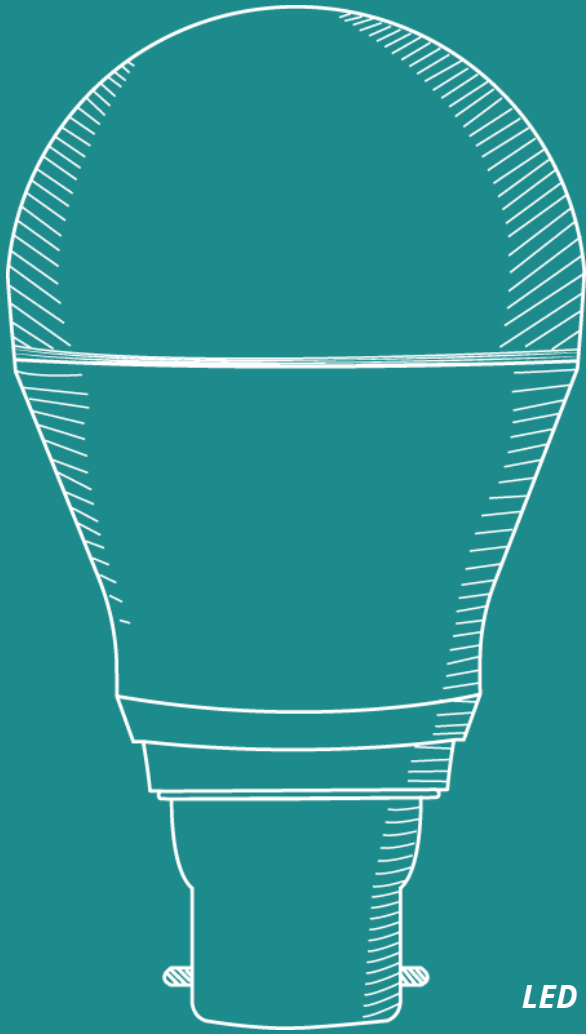

*LED replacement globes are a quick and easy way to upgrade to energy efficient lighting without investing in a complete infrastructure overhaul.*

*Incandescent lamps retain significantly more heat than retrofit LED lamps before suffering any structural damage, given their lack of electronic components.*

*Therefore care should be taken in making sure there is plenty of ventilation for the retrofit LED lamp.*

# RETRO FIT

## ■ KITS



RETRO 7W KIT  
p170

## ■ LAMPS



A60 LAMP  
p171



PAR 38 LAMP  
p172

## ■ TUBES



LED TUBE  
p173

# RETRO 7W KIT

## LED Retrofit Lamp

170

RETRO FIT

### DESCRIPTION

RETRO 7W KIT is an energy efficient replacement kit with a range of trim accessory options and remote driver with flex and plug for hassle free installation.

### KEY FEATURES

- Superior substitute for halogen with a 40mm profile to suit most spaces
- Excellent luminous efficacy
- Remote driver
- Diecast aluminium alloy construction
- Choice of square or circular trims in white or silver
- Multifaceted polycarbonate lens



Standards



POWER	LUMEN	lm/W	CCT	SAP CODE	PRODUCT CODE
7W	650 lm	93 lm/W	3000K	2000890	<b>RETRO7WRF-3K</b>
7W	730 lm	104 lm/W	5000K	2000747	<b>RETRO7WRF-5K</b>

ACCESSPROES	FEATURE	SAP CODE	PRODUCT CODE
Trim Ø108mm Outer diameter Ø90mm cut-out	Round White	2000261	<b>HHG108B</b>
	Round Chrome	2000260	<b>HHG108A</b>
Trim 100 x 100mm Outer dimension 90 x 90mm cutout	Square Silver	2000259	<b>HHG100SQB</b>

Dimensions

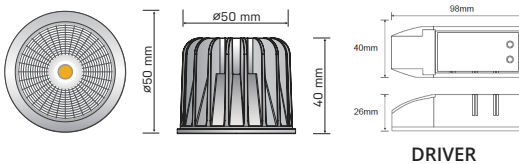

DRIVER



ROUND CHROME

ROUND WHITE

SQUARE SILVER

Accessories

# A60 LAMP

## LED Retrofit Lamp



### DESCRIPTION

RETRO LAMP A60 is the perfect LED replacement lamp for existing luminaires.

### KEY FEATURES

- Edison E27 screw and bayonet B22 lamp base available
- Opal diffuser
- Low glare output

Standards



POWER	FEATURE	LUMEN	lm/W	CCT	SAP CODE	PRODUCT CODE
9W	Edison E27	820 lm	91 lm/W	3000K	2000067	<b>B9W60R3KE27</b>
9W	Bayonet B22	820 lm	91 lm/W	3000K	2000066	<b>B9W60R3KB22</b>
9W	Edison E27	980 lm	109 lm/W	6500K	2000069	<b>B9W60R6KE27</b>
9W	Bayonet B22	980 lm	109 lm/W	6500K	2000068	<b>B9W60R6KB22</b>

Dimensions

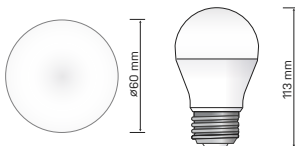

B9W60R3KE27

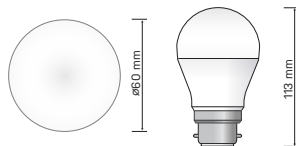

B9W60R3KB22



# PAR 38 LAMP

## LED Retrofit Lamp

172

RETRO FIT



### DESCRIPTION

The PAR38 LAMP is a simple LED retrofit lamp for existing luminaires.

### KEY FEATURES

- Edison E27 screw lamp base
- IP54 weather resistance
- Opal diffuser
- Low glare output

Standards



POWER	FEATURE	LUMEN	lm/W	CCT	SAP CODE	PRODUCT CODE
15W	Edison E27	1390 lm	93 lm/W	5000K	2000821	<b>PAR15W38-5K</b>

Dimensions

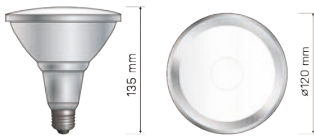

# LED TUBE

## LED Retrofit Lamp



### DESCRIPTION

The LED TUBE supersedes old fluorescent tubes and not only delivers better energy efficiency, but also has a safer, more enduring and virtually unbreakable non toxic tube.

### KEY FEATURES

- Provides over 50% energy savings when replacing conventional fluorescent tubes
- Virtually unbreakable polycarbonate body with glass and mercury free

### Standards



POWER	FEATURE	LUMEN	lm/W	CCT	SAP CODE	PRODUCT CODE
7W	600mm	850 lm	121 lm/W	6500K	2001135	<b>LEDTUBE7W06-6K</b>
11W	1200mm	1590 lm	145 lm/W	4000K	-	<b>LEDTUEB10W12-4K</b>
11W	1200mm	1590 lm	145 lm/W	6500K	-	<b>LEDTUBE10W12-6K</b>

### Dimensions

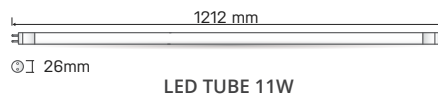
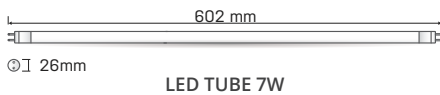

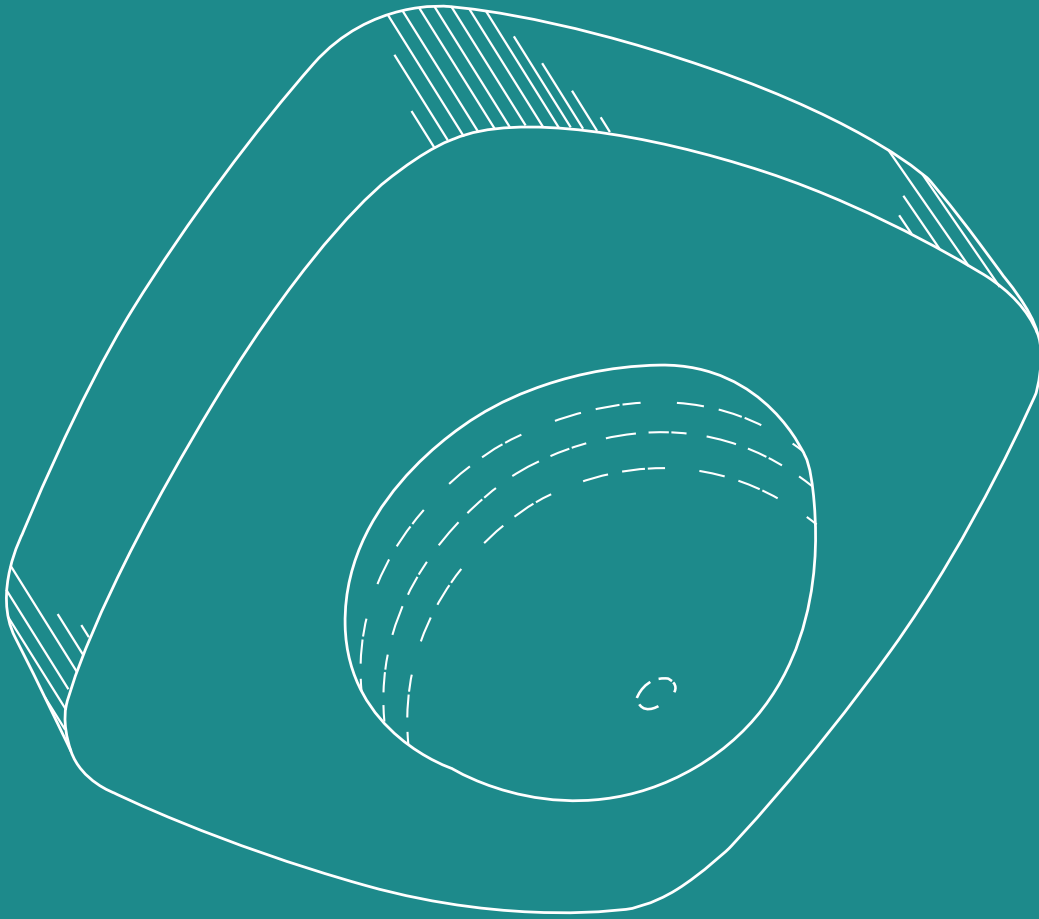

*Haneco have an extensive range of intelligent LED lighting controls including dimmers, sensors, and KASTA, smart home automation products.*

# LIGHTING CONTROL

## ■ DIMMER



DUO 350 **p176**

## ■ SENSOR



SENTURA **p177**

INTELLISENSOR

**p178**

SMART LIGHTING  
CONTROL (KASTA)

**p184**



# DUO 350

## Trailing Edge Dimmer



BLACK



WHITE



### DESCRIPTION

The DUO Trailing edge dimmer is designed to offer smooth and reliable dimming of Haneco LED luminaires with adjustable minimum setting to avoid flickering and lag.

### KEY FEATURES

- Maximum load 350W
- Compatible with most standard wall plates and apertures
- Integrated switch and dimmer knob
- Load correction capacitor included for loads under 10W
- Easy to locate in the dark with subtle backlighting that can be turned off
- Simple 2 wire design for easy installation

Standards



FEATURE	SAP CODE	PRODUCT CODE
DUO Dimmer	2001203	<b>DUO350W-W</b>
Black Knob	2001214	<b>DUO-KNOB-BK</b>

# SENTURA

## PIR Motion Sensor



### DESCRIPTION

The SENTURA is a ceiling mounted 360° PIR sensor with IP65 weatherproof with detection range up to 20m. It is ideal for applications such as corridors and carports.

### KEY FEATURES

- Passive Infrared motion sensor
- 3-wire input design
- 360° detection
- 10s to 30min time setting
- 3 to 2000lux level setting
- Maximum load: 2000W (Incandescent)
- 1000W (Fluorescent & LED)
- IP65 weather resistance

Standards



FEATURE	SAP CODE	PRODUCT CODE
SENTURA 360° IP65 PIR sensor	2001528	<b>SENTURA-SMPIR360</b>

# INTELLISENSOR

## Smart Auto Stand By Lighting Solution

The HANECO Intellisensor is a smart, easily adjustable, auto dimming function that will revolutionise standby lighting.

- The 5-way programmable DIM switches give you total control
- On time - for automatically full illumination up to 30 minutes
- Standby time - for automatically dimmed standby mode, from 0 seconds to permanent standby
- Standby level - adjustable to 4 light levels to suit your security/safety requirements
- Daylight override - to save energy during the day (>50Lux)
- Detection range - adjustable sensitivity, either 100% (approx. 5m) or 50% (approx. 3m)

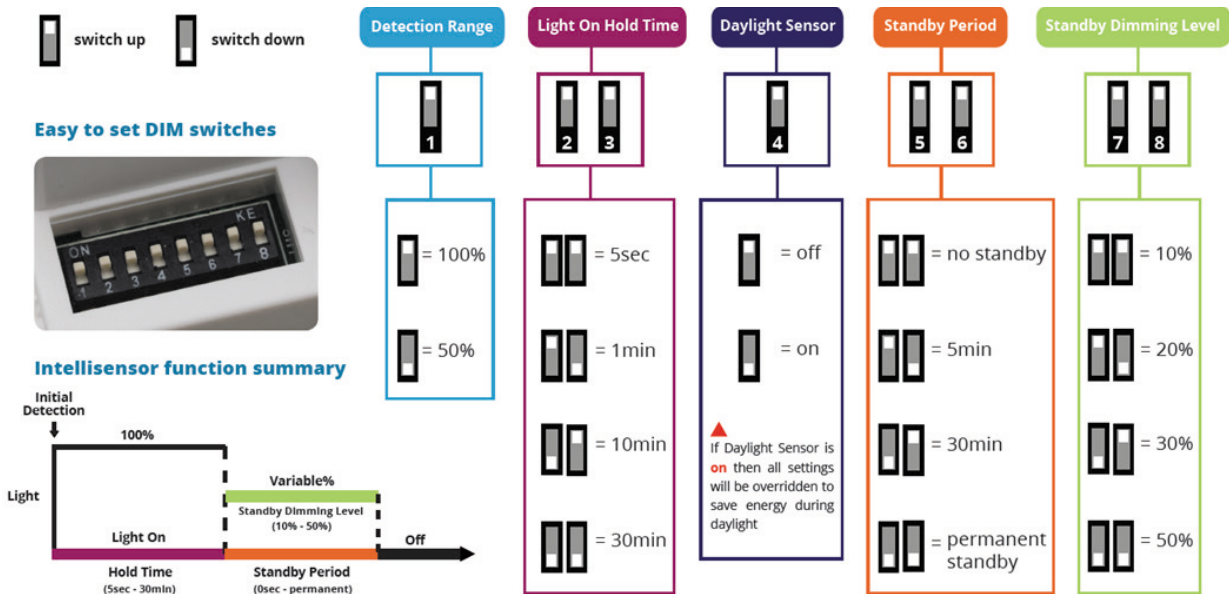

Available on **PURO / PLUTO** oyster, **VISTA / TRIPROOF** batten.

For more information and simplified setting guide, go to [www.haneco.com.au/intellisensor](http://www.haneco.com.au/intellisensor)

**RECOMMENDED INTELLISENSOR SETTINGS**

**Stairwell**

Detection Range(SW1)	100%
Light ON hold time (SW2/3)	1min at Max Output
Daylight Sensor(SW4)	Off (Disable)
Standby Period (SW5/6)	Permanent ∞
Standby Level (SW7/8)	30% of Max Output

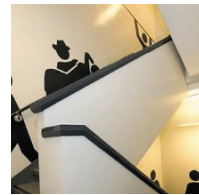
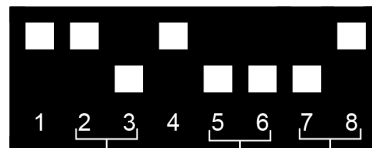

**Building Perimeter / Entry | Exit**

Detection Range(SW1)	100%
Light ON hold time (SW2/3)	10mins at Max Output
Daylight Sensor(SW4)	On (50lux)
Standby Period (SW5/6)	Permanent ∞
Standby Level (SW7/8)	10% of Max Output

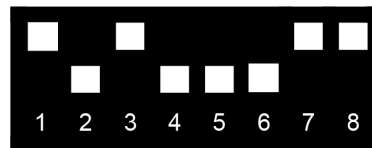

**Corridor**

Detection Range(SW1)	100%
Light ON hold time (SW2/3)	10mins at Max Output
Daylight Sensor(SW4)	Off (Disable)
Standby Period (SW5/6)	Permanent ∞
Standby Level (SW7/8)	20% of Max Output

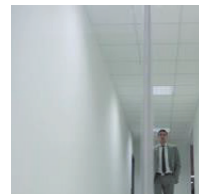
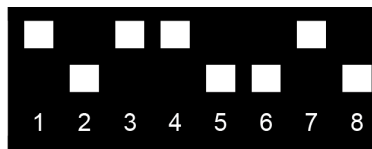

**Carpport**

Detection Range(SW1)	100%
Light ON hold time (SW2/3)	10mins at Max Output
Daylight Sensor(SW4)	Off (Disable)
Standby Period (SW5/6)	No standby
Standby Level (SW7/8)	NOT APPLICABLE

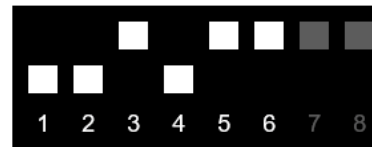

**Classroom, workshop / small factory**

Detection Range(SW1)	100%
Light ON hold time (SW2/3)	30mins at Max Output
Daylight Sensor(SW4)	Off (Disable)
Standby Period (SW5/6)	30mins
Standby Level (SW7/8)	30% of Max Output



**Office / Meeting Room**

Detection Range(SW1)	50%
Light ON hold time (SW2/3)	10mins at Max Output
Daylight Sensor(SW4)	On (50lux)
Standby Period (SW5/6)	5mins
Standby Level (SW7/8)	10% of Max Output

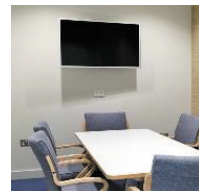
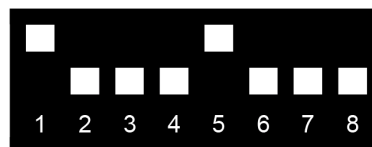

**Laundry / Patio**

Detection Range(SW1)	50%
Light ON hold time (SW2/3)	10mins at Max Output
Daylight Sensor(SW4)	Off (Disable)
Standby Period (SW5/6)	5mins
Standby Level (SW7/8)	10% of Max Output

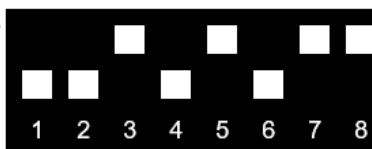



# PURO 400

## Tritone Intellisensor LED Oyster



### DESCRIPTIONS

The PURO is an ideal oyster light that is ideal for residential applications. The opal acrylic diffuser provides even light distribution to the space and large terminal block for easy installation.

### KEY FEATURES

- Selectable colour temperature - 3000K, 4200K and 5700K
- Opal acrylic diffuser
- Optional dimmable driver

### APPLICATIONS

Residential

### Standards



**TRITONE**  
colour changeable

POWER	FEATURE	LUMEN	lm/W	CCT	WEIGHT	SAP CODE	PRODUCT CODE
25W	Tritone Intellisensor	1690 lm	68 lm/W	3000K	0.80 kg	2000111	<b>CL25W400R-MUL-SS</b>
		1840 lm	74 lm/W	4200K			
		1800 lm	72 lm/W	5700K			

### EMERGENCY SPECIFICATION

FEATURE	LUMEN	lm/W	CCT	EMERGENCY CLASSIFICATION	BATTERY TYPE	WEIGHT	SAP CODE	PRODUCT CODE
Tritone Intellisensor Emergency	1690 lm	68 lm/W	3000K	C0=D32, C90=D32	LiFePO4	1.20 kg	2000110	<b>CL25W400R-MUL-EM-SS</b>
	1840 lm	74 lm/W	4200K					
	1800 lm	72 lm/W	5700K					

### Dimensions

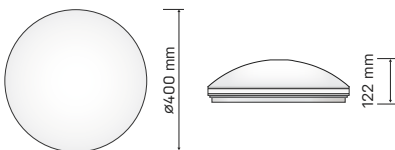

Refer **p56** for standard versions or **p164** for emergency versions.

# PLUTO

## Weatherproof Tritone Intellisensor LED Oyster



### DESCRIPTIONS

The PLUTO is an ideal oyster light that is ideal for residential and commercial applications. The opal acrylic diffuser provides even light distribution to the space and large terminal block for easy installation.

### KEY FEATURES

- Selectable colour temperature - 3000K, 4200K and 5700K
- Opal acrylic diffuser
- IP54 insect resistant design
- Intellisensor with corridor function available

### APPLICATIONS

Residential, Schools, Offices, Stairwells

### Standards



POWER	FEATURE	LUMEN	lm/W	CCT	WEIGHT	SAP CODE	PRODUCT CODE
25W	Tritone Intellisensor	1690 lm	68 lm/W	3000K	1.10 kg	2000119	<b>CL25W400WP-MUL-SS</b>
		1840 lm	74 lm/W	4200K			
		1800 lm	72 lm/W	5700K			

### EMERGENCY SPECIFICATION

POWER	FEATURE	LUMEN	lm/W	CCT	EMERGENCY CLASSIFICATION	BATTERY TYPE	WEIGHT	SAP CODE	PRODUCT CODE
25W	Tritone Intellisensor Emergency	1690 lm	68 lm/W	3000K	C0=D32, C90=D32	LiFePO4	1.50 kg	2000118	<b>CL25W400WP-MUL-EM-SS</b>
		1840 lm	74 lm/W	4200K					
		1800 lm	72 lm/W	5700K					

### Dimensions

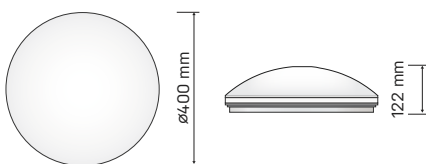

TRIPROOF20/40W12-TRI-SS

Refer **p55** for standard versions or **p165** for emergency versions.

# VISTA

## Intellisensor LED batten

LIGHTING CONTROL



### DESCRIPTIONS

The perfect LED replacement for conventional battens, VISTA offers efficiency with excellent light distributions. Intellisensor motion sensor with corridor function and dual power selection further enhance energy savings and Lithium Iron Phosphate (LiFePO4) battery version is available where emergency lighting is required.

### KEY FEATURES

- Selectable colour temperature - 4000K, 4700K and 5700K
- Dual power selection available in 1200mm length only
- Quick and easy installation
- Intellisensor motion sensor with corridor function available
- Lithium Iron Phosphate (LiFePO4) battery emergency version available

### APPLICATIONS

Residential, Schools, Offices, Retailers, Factories, Carpark, Stairwells

Standards



### NOMINAL LENGTH 1221MM

FEATURE	STANDARD MODE			LOW POWER MODE			CCT	EMERGENCY CLASSIFICATION	BATTERY TYPE	SAP CODE	PRODUCT CODE
	POWER	LUMEN	lm/W	POWER	LUMEN	lm/W					
Intellisensor	40W	4540lm	114lm/W	N/A	N/A	N/A	4000K	-	-	2001064	VISTA40W12-TRI-SS
		4880lm	122lm/W				4700K				
		4470lm	112lm/W				5700K				
Intellisensor Emergency	40W	4540lm	114lm/W	N/A	N/A	N/A	4000K	C0=D50, C90=D32	LiFePO4	2001065	VISTA40W12-TRI-SS-EM
		4880lm	122lm/W				4700K				
		4470lm	112lm/W				5700K				

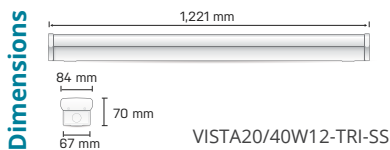

Refer p89 for standard versions or p159 for emergency versions.

# TRIPROOF

## Weatherproof Intellisensor LED Batten



### DESCRIPTIONS

The perfect LED replacement for conventional weatherproof battens, the robust TRIPROOF offers IP65 weatherproof and IK08 impact rating. Intellisensor motion sensor with corridor function and dual power selection further enhance energy savings and Lithium Iron Phosphate (LiFePO4) battery version is available where emergency lighting is required.

### KEY FEATURES

- Selectable colour temperature - 4000K, 5000K and 6500K
- Dual power selection available in 1200mm length only
- Quick and easy installation
- Intellisensor motion sensor with corridor function available
- Lithium Iron Phosphate (LiFePO4) battery emergency version available

### APPLICATIONS

Residential, Schools, Factories, Carpark, Stairwells, Public Areas

Standards



1215MM

	STANDARD MODE			LOW POWER MODE			EMERGENCY SPECIFICATION					
FEATURE	POWER	LUMEN	lm/W	POWER	LUMEN	lm/W	CCT	WEIGHT	EMERGENCY CLASSIFICATION	BATTERY TYPE	SAP CODE	PRODUCT CODE
Intellisensor	N/A	N/A	N/A	20W	2230lm	112lm/W	4000K	2.00kg	-	-	2001067	<b>TRIPROOF 40W12-TRI-SS</b>
					2250lm	113lm/W	5000K					
					1970lm	99lm/W	6500K					
Intellisensor Emergency	N/A	N/A	N/A	20W	2230lm	112lm/W	4000K	2.20kg	C0=D63, C90=D32	LiFePO4	2001068	<b>TRIPROOF 40W12-TRI-SS -EM</b>
					2250lm	113lm/W	5000K					
					1970lm	99lm/W	6500K					

Dimensions

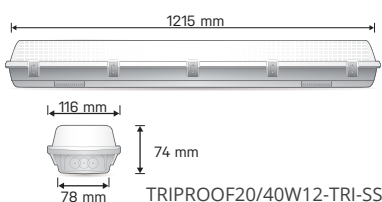

Refer p99 for standard versions or p163 for emergency versions.



KASTA TECHNOLOGIES





## ENHANCE

Using reliable Bluetooth technology, KASTA is the simplest and most affordable way to securely connect home lighting and appliances wirelessly without the need for internet, complicated programming or a degree in engineering. Just connect it to a power source and use it like a traditional switch and/or with the KASTA free mobile app. Your choice!

KASTA is a true retrofit smart home solution as there's no need for complex, time-consuming and proprietary cabling. Simply install the KASTA device, configure it within a couple of minutes with your mobile device, and presto! Now you can enjoy multi-way switching and dimming of lights from just about anywhere (up to 9-way), and with KASTA's optional battery-operated switch, even from places where traditional wall switches could not have been installed.

KASTA is also a suitable for commercial lighting control applications, simplifying the installation, configuration and control of LED highbays in industrial areas and other large spaces.





**PRODUCTS**

KASTA's mechanism dimmers and switch relays are 2-wire devices that easily retrofit onto compatible grid plates (such as Clipsal, HPM, Voltex and Trader), with no neutral required at the switch location, allowing you to easily create multi-way switching and dimming control, group control, scene control, master off control, and more, plus set up schedules and timers as well.

From smart automated solutions that add convenience into a home to expanded electrical solutions that overcome wiring limitations in commercial spaces, the suite of KASTA products applies to a wide variety of custom applications that empower tradesmen to stay ahead of the curve by future-proofing their work with an ever expanding range of modular control solutions.

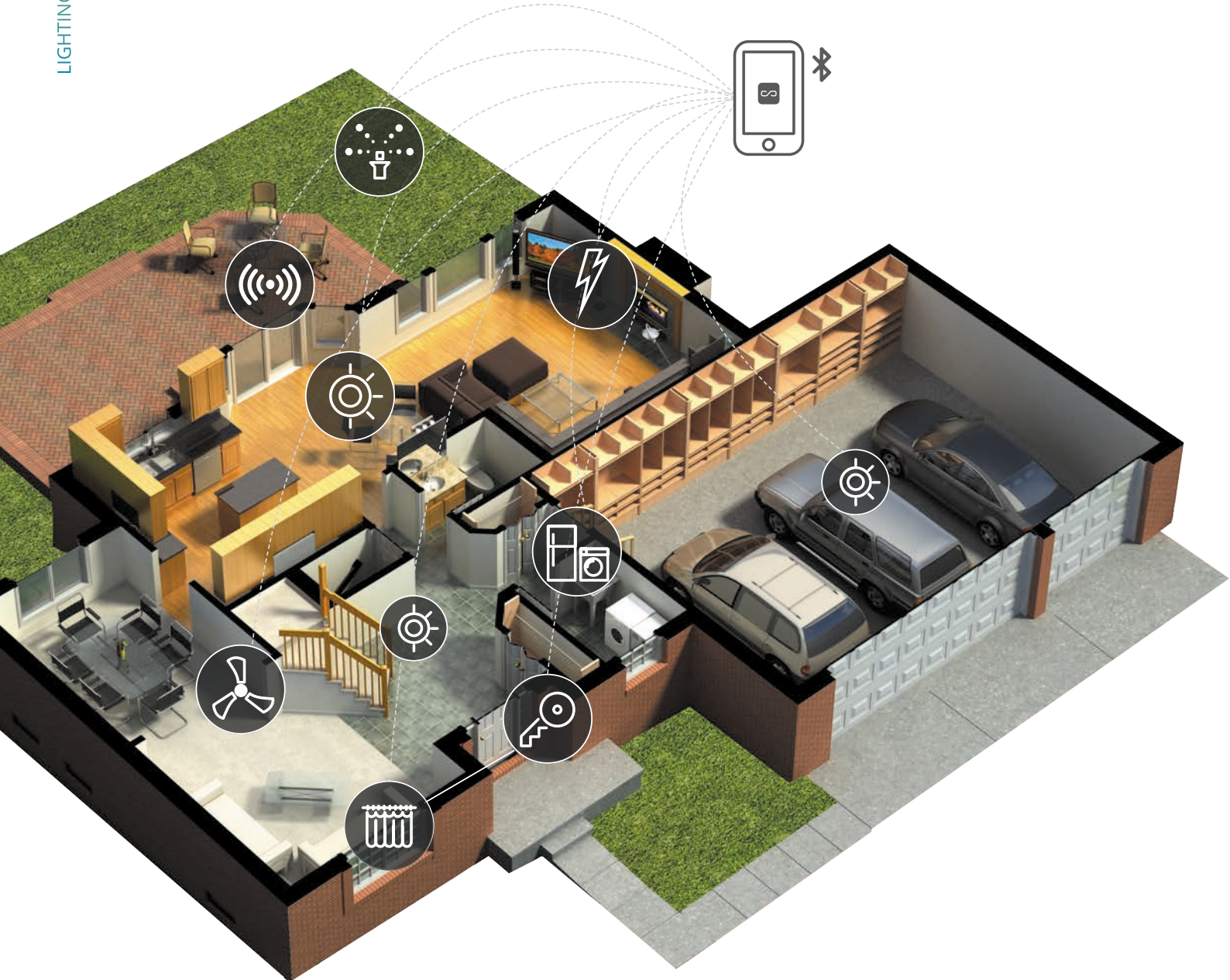

 LIGHTING

 AIR MOVEMENT/  
CLIMATE

 SENSORS

 BLINDS

 IRRIGATION

 SECURITY

 APPLIANCES

 ENERGY

	Product Code	Description	Details
	<b>KASTA-D350BH-W</b>	Dimmer Mechanism	<ul style="list-style-type: none"> <li>2-wire phase-cut Trailing Edge 350W dimmer mechanism</li> <li>Push button ON/OFF and dimming control</li> <li>Suits most Australian grid plates</li> <li>Supplied with 1 pair of White button caps (2 styles)</li> </ul>
	<b>KASTA-S350BH-W</b>	Switch Relay Mechanism	<ul style="list-style-type: none"> <li>2-wire 350W switch relay mechanism</li> <li>Push button ON/OFF control</li> <li>Suits most Australian grid plates</li> <li>Supplied with 1 pair of White button caps (2 styles)</li> </ul>
	<b>KASTA-RB02-W</b>	Battery Powered Remote Switch Mechanism	<ul style="list-style-type: none"> <li>Push button multi-way control of KASTA devices</li> <li>Trigger KASTA automation functions (scenes, groups, etc)</li> <li>Suits most Australian grid plates</li> <li>Supplied with 1 pair of White button caps (2 styles)</li> </ul>
	<b>KASTA-CAPS-B</b>	Black Button Caps	<ul style="list-style-type: none"> <li>Button caps to suit KASTA mechanism devices</li> <li>Suits KASTA dimmer, switch relay and remote switch mechanism devices</li> <li>Includes 5 pairs of black button caps (2 styles)</li> </ul>
	<b>KASTA-D300IBH</b>	Dimmer Module	<ul style="list-style-type: none"> <li>Phase cut Trailing Edge 300W dimmer module</li> <li>ON/OFF and dimming control</li> <li>5-wire connection (Power, Load &amp; Momentary Switch)</li> <li>Suits most Australian grid plates using a push button momentary action mechanism</li> </ul>
	<b>KASTA-S2400IBH</b>	Switch Relay Module	<ul style="list-style-type: none"> <li>2400W switch relay module</li> <li>ON/OFF control</li> <li>5-wire connection (Power, Load &amp; Momentary Switch)</li> <li>Suits most Australian grid plates using a push button momentary action mechanism</li> </ul>
	<b>KASTA-C300IBH</b>	Curtain Control Module	<ul style="list-style-type: none"> <li>300W curtain control module</li> <li>Control AC or DC powered curtain and blind motors – OPEN/STOP/CLOSE</li> <li>7-wire connection (Power, Motor &amp; Momentary Switch)</li> <li>Suits most Australian grid plates using a push button momentary action mechanism</li> </ul>
	<b>KASTA-RSIBH</b>	Remote Switch Input Module	<ul style="list-style-type: none"> <li>Communicate with and control other KASTA devices</li> <li>2 modes of operation – Toggle Input &amp; Momentary Switch Input</li> <li>3-wire connection (Power, Input)</li> <li>Suits most Australian grid plates using a push button momentary action mechanism</li> <li>Also suits toggle input such as the Load output from a PIR sensor</li> </ul>
	<b>KASTA-S10IBH</b>	Dry Contact Output Module	<ul style="list-style-type: none"> <li>Provides a voltage free relay output for ON/OFF control of equipment such as garage doors and motorised gates</li> <li>4 modes of operation – 1/6/9 sec Pulse ON (auto OFF) &amp; Toggle ON/OFF</li> <li>6-wire connection (Power, Load &amp; Momentary/Toggle Switch)</li> <li>Suits most Australian grid plates using a push button momentary or toggle action mechanisms</li> </ul>
	<b>KASTA-FC150A</b>	AC Ceiling Fan Controller	<ul style="list-style-type: none"> <li>3-speed control of AC ceiling sweep fans up to 150W</li> <li>Contains relay for ON/OFF control of fan light</li> <li>7-wire connection (Power, Fan, Light &amp; Momentary Switch)</li> <li>Easily installed under the fan canopy</li> </ul>
	<b>KASTA-1BMBH-W</b>	Mains Powered Remote Switch Mechanism	<ul style="list-style-type: none"> <li>Push button multi-way control of KASTA devices</li> <li>Trigger KASTA automation functions (scenes, groups, etc)</li> <li>Suits most Australian grid plates</li> <li>Supplied with 1 pair of White button caps (2 styles)</li> </ul>
	<b>SLO2AB-BH</b>	Daylight Sensor	<ul style="list-style-type: none"> <li>Mains powered ambient daylight sensor</li> <li>Used in combination with the KASTA 1-10V dimmer for daylight harvesting control of LED highbays</li> <li>Mesh one daylight sensor with multiple KASTA 1-10V dimmers for group control</li> </ul>
	<b>D1-10VIBH</b>	1-10V Dimmer	<ul style="list-style-type: none"> <li>Mains powered 1-10V dimmer</li> <li>Suits LED highbays with 1-10V input control</li> <li>Manually operated from a momentary switch or KASTA devices</li> <li>Can be used in combination with the KASTA Smart 1-10V daylight sensor for daylight harvesting control</li> </ul>

Proudly distributed in Australia by





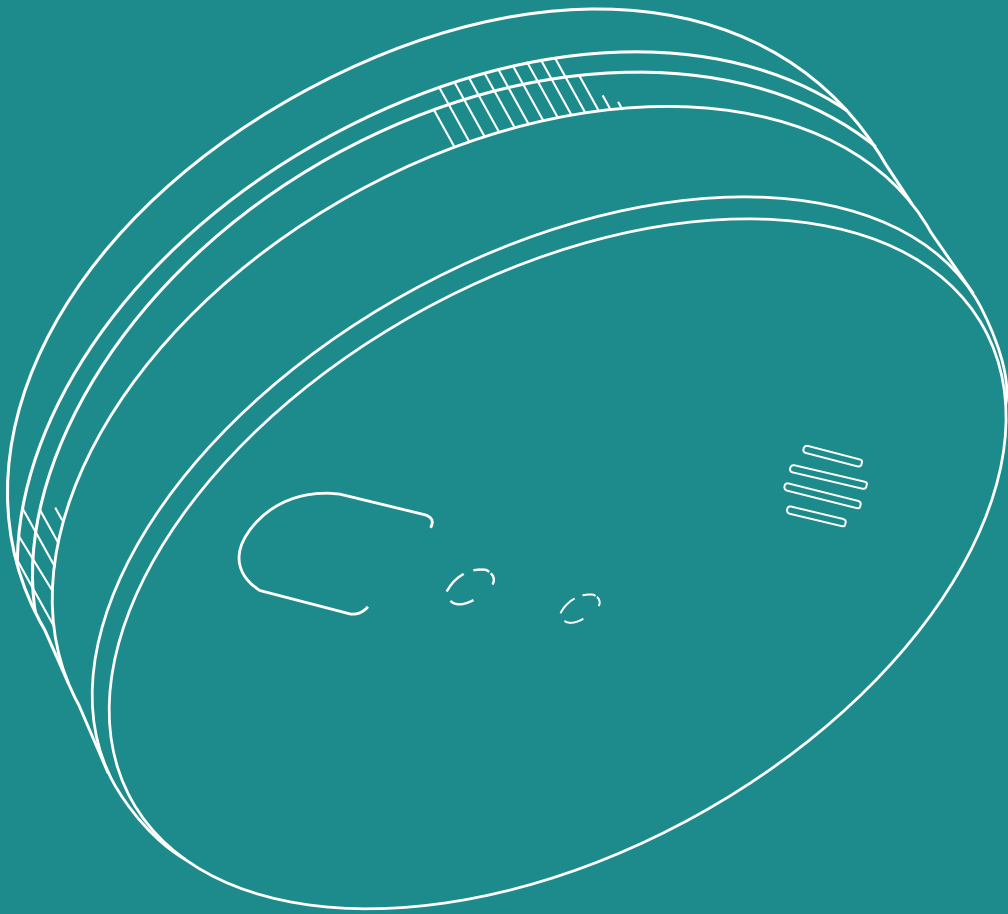

# SECURITY



SMOXE **p190**



AGILIS **p191**

# SMOXE

## Photoelectric Smoke Alarm



### DESCRIPTION

The SMOXE is a hardwired with 9V DC battery backup surface mount photoelectric smoke alarm.

### KEY FEATURES

- Surface mount
- Photoelectric technology
- 9V DC battery backup
- Robust design

Standards



FEATURE	SAP CODE	PRODUCT CODE
SMOXE smoke alarm	2001464	<b>SMOXE240V-B1YHW</b>
SMOXE connector base	2000 845	<b>SMOXE240V-518TBOX-SLEEVE</b>

# AGILIS

## Photoelectric Smoke Alarm



### DESCRIPTION

The device is a photoelectric smoke alarm with wireless. With the photoelectric technology, it is more sensitive to detecting against smouldering fires and black smoke.

### KEY FEATURES

- Wireless Interconnect-able with up to 40 detectors
- Built-in Lithium battery with 10 years battery life
- Wireless distance: >100m in clear field
- >85 dB(A) alarm with flashing red indicator
- Complies with Australian Standard 3786:2014
- Suitable for ceiling and wall mounting

Standards



FEATURE	SAP CODE	PRODUCT CODE
AGILIS smoke alarm	-	<b>AG300</b>





*Haneco have an extensive range of LED drivers  
for replacement solution.*

# ACCESSORIES

DOWNLIGHT  
DIMMABLE DRIVER  
**p194**

OYSTER  
DIMMABLE DRIVER  
**p194**

BATTEN  
DIMMABLE DRIVER  
**p194**

PANEL - NON  
DIMMABLE DRIVER  
**p195**

FLEXION LED STRIP  
DRIVER (12V & 24V)  
**p196**

FLEXION LED STRIP  
DIMMABLE DRIVER  
**p196**

# REPLACEMENT LED DRIVER

LEDs can outlast drivers. Don't throw out a perfectly good luminaire when there is a simple solution.

## DOWNLIGHT - DIMMABLE DRIVER

COMPATIBLE	SPECIFICATION	SAP CODE	PRODUCT CODE
Downlights with Remote driver	Dimmable 7.5-12W Driver Constant Current 260mA 29-46V	2000272	<b>HN-0612-260MA</b>
Downlights with Remote driver	Dimmable 9-12W Driver Constant Current 500mA 25-42V	2001060	<b>HN-1950W-0500</b>
Dimmable Downlights with Remote driver	Dimmable 1-20W Driver Constant Current 500mA 25-42V	2000628	<b>HN-1318W-0500 DIMMABLE</b>

## OYSTER - DIMMABLE DRIVER

COMPATIBLE	SPECIFICATION	SAP CODE	PRODUCT CODE
PURO 300	Dimmable 7-21W Driver Constant Current 350mA 20-60V	2001217	<b>HN-0721W-0350 DIMMABLE</b>
PURO 400 PLUTO 400	Dimmable 9-28W Driver Constant Current 600mA 21-42V	2001218	<b>HN-0928W-0600 DIMMABLE</b>

## BATTEN - DIMMABLE DRIVER

COMPATIBLE	SPECIFICATION	SAP CODE	PRODUCT CODE
VISTA 20/40W 1200mm	Dimmable 20-40W Driver Constant Current 700mA 28-58V	2000896	<b>HN-1440W-0700 DIMMABLE</b>
TRIPROOF 20/40W 1200mm"	Dimmable 20-40W Driver Constant Current 700mA 28-58V	2000896	<b>HN-1440W-0700 DIMMABLE</b>
TRIPROOF 20/40W 1200mm	Dimmable 28-42W Driver Constant Current 700mA 40-60V	2000288	<b>HN-1950W-0700</b>

# REPLACEMENT LED DRIVER

LEDs can outlast drivers. Don't throw out a perfectly good luminaire when there is a simple solution.

## PANEL - NON DIMMABLE DRIVER (FLICKER FREE)

COMPATIBLE	SPECIFICATION	SAP CODE	PRODUCT CODE
MATRIX 600 x 600mm	Flicker Free 18W Driver Constant Current Non-Dim 420mA 42V	2001390	<b>HN-1318W-0420-FF</b>
MATRIX 300 x 1200mm	Flicker Free 18W Driver Constant Current Non-Dim 420mA 42V	2001390	<b>HN-1318W-0420-FF</b>
GALAXY 300 x 1200mm	Flicker Free 18W Driver Constant Current Non-Dim 420mA 42V	2001390	<b>HN-1318W-0420-FF</b>
MATRIX 600 x 600mm	Flicker Free 28W Driver Constant Current Non-Dim 700mA 42V	2001192	<b>HN-0240W-0700-FF</b>
MATRIX 300 x 1200mm	Flicker Free 28W Driver Constant Current Non-Dim 700mA 42V	2001192	<b>HN-0240W-0700-FF</b>
GALAXY 300 x 1200mm	Flicker Free 28W Driver Constant Current Non-Dim 700mA 42V	2001192	<b>HN-0240W-0700-FF</b>
MATRIX 600 x 1200mm	Flicker Free 40W Driver Constant Current Non-Dim 1050mA 42V	2001193	<b>HN-0240W-1050-FF</b>
MATRIX 600 x 1200mm	Flicker Free 60W Driver Constant Current Non-Dim 1500mA 42V	2001391	<b>HN-5680W-1400-FF</b>

## PANEL - NON DIMMABLE DRIVER

COMPATIBLE	SPECIFICATION	SAP CODE	PRODUCT CODE
MATRIX 600 x 600mm	Dimmable 13-20W Driver Constant Current 500mA 25-42V	2000628	<b>HN-1318W-0500 DIMMABLE</b>
MATRIX 300 x 1200mm	Dimmable 13-20W Driver Constant Current 500mA 25-42V	2000628	<b>HN-1318W-0500 DIMMABLE</b>
GALAXY 300 x 1200mm	Dimmable 13-20W Driver Constant Current 500mA 25-42V	2000628	<b>HN-1318W-0500 DIMMABLE</b>
MATRIX 600 x 600mm	Dimmable 26-44W Driver Constant Current 1050mA 42V	2000285	<b>HN-1950W-1050</b>
MATRIX 300 x 1200mm	Dimmable 26-44W Driver Constant Current 1050mA 42V	2000285	<b>HN-1950W-1050</b>
MATRIX 600 x 1200mm	Dimmable 26-44W Driver Constant Current 1050mA 42V	2000285	<b>HN-1950W-1050</b>
GALAXY 300 x 1200mm	Dimmable 26-44W Driver Constant Current 1050mA 42V	2000285	<b>HN-1950W-1050</b>



# REPLACEMENT LED DRIVER

LEDs can outlast drivers. Don't throw out a perfectly good luminaire when there is a simple solution.

## FLEXION LED STRIP - 12V DRIVER

SPECIFICATION	SAP CODE	PRODUCT CODE
FLEXION 12V Driver 0-75W 12V constant voltage	2000610	<b>HN-0075-12V</b>

## FLEXION LED STRIP - 24V DRIVER

SPECIFICATION	SAP CODE	PRODUCT CODE
FLEXION 24V Driver 0-40W 24V constant voltage	2000918	<b>HN-0040-24V</b>
FLEXION 24V Driver 0-75W 24V constant voltage	2000988	<b>HN-0075-24V-IP20</b>
FLEXION 24V Driver 0-75W 24V constant voltage IP65	2000611	<b>HN-0075-24V-IP65</b>
FLEXION 24V Driver 0-100W 24V constant voltage IP67	2000613	<b>HN-0100-24V</b>
FLEXION 24V Driver 0-150W 24V constant voltage IP67	2000616	<b>HN-0150-24V</b>
FLEXION 24V Driver 0-240W 24V constant voltage IP67	2000265	<b>HN-0240-24V</b>

## FLEXION LED STRIP - 24V DIMMABLE DRIVER

SPECIFICATION	SAP CODE	PRODUCT CODE
FLEXION 24V Dimmable Driver 0-25W 24V constant voltage	2000828	<b>HD-0025-24V</b>
FLEXION 24V Dimmable Driver 0-50W 24V constant voltage	2000829	<b>HD-0050-24V</b>
FLEXION 24V Dimmable Driver 0-200W 24V constant voltage IP67	2000830	<b>HD-0200-24V</b>

# STANDARDS

## IP Rating

IP stands for Ingress Protection. It is a way of rating how well protected the device is from things that can get into it. The first number rating solid objects and dust from 1 to 6. The second figure is the water protection rating. The range is from 1 for slow dripping water from above up to 8 for a device that can be submerged.

### First number: **Solid Objects**

-  **0** Not protected
-  **1** Protected against objects larger than 50mm
-  **2** Protected against objects larger than 12.5mm
-  **3** Protected against objects larger than 2.5mm
-  **4** Protected against objects larger than 1mm
-  **5** Dust protected. Protects ingress of dust sufficient to cause harm.
-  **6** Dust tight. No ingress of dust.

### Second number: **Liquids**

-  **0** Not protected
-  **1** Protected against dripping water
-  **2** Protected against dripping water when tilted up to 15 degrees
-  **3** Protected against spraying water at an angle of up to 60 degrees
-  **4** Protected against splashing water from any direction
-  **5** Protected against jets of water from any direction
-  **6** Protected against heavy seas and powerful jets of water
-  **7** Protected against the effects of temporary immersion in water
-  **8** Protected against the effects of continuous immersion in water



## IK Rating

The IK rating refers to impact protection. It is a 1 to 10 system with a higher number indicating a more robust product able to withstand a greater impact. IK10 can withstand a 4 litre tin of paint dropped on it from just under half a metre.

IK Code	Impact Energy (J)	Equivalent Impact
IK00	(no protection)	(no test)
IK01	0.14	Drop of 200g object from 7.5cm
IK02	0.2	Drop of 200g object from 10cm
IK03	0.3.5	Drop of 200g object from 17.5cm
IK04	0.5	Drop of 200g object from 25cm
IK05	0.7	Drop of 200g object from 35cm
IK06	1	Drop of 500g object from 20cm
IK07	2	Drop of 500g object from 40cm
IK08	5	Drop of 1700g object from 29.5cm
IK09	10	Drop of 5000g object from 20cm
IK10	20	Drop of 5000g object from 40cm



## IC Rating

IC stands for 'insulation contact' and determines whether downlights can safely come into contact with potentially flammable material or with any covering that might interfere with the luminaire's cooling system.

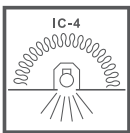

### IC-4

- Suitable for residential or commercial use
- Fitting can be covered with building insulation
- Can be used where air transfer is not permitted or not desired between living space & roof space

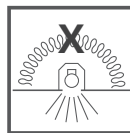

### Do not cover

- Suitable for residential or commercial use in AU.
- Fitting cannot be covered with building insulation
- Insulation must be placed as per clearance distances according to manufactures installation guide

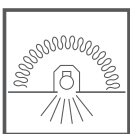

### IC

- Suitable for residential or commercial use
- Fitting can be loosely covered with building insulation
- Can be used where some air transfer is permitted or desired between living space & roof

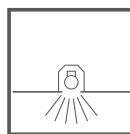

### Non-IC

- Suitable for commercial use only
- Not suitable for use in residential dwellings or other places where insulation may be installed now or in the future
- Not tested for use with building insulation

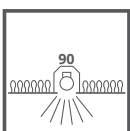

### CA 90

- Suitable for residential or commercial use
- Fitting cannot be covered with building insulation
- Insulation can be placed against the sides of the fitting



## Lumen

Lumens are a measure of the quantity of visible light emitted. The more lumens, the more light. Watts refers to the amount of energy consumed. LEDs have dramatically improved the conversion of power (watts) into visible light (lumens). A 60W LED now emits at least five times as much light as an old 60W incandescent bulb.



## HACCP

HACCP Australia is a leading food science organisation that certifies products as food safe and appropriate for use in food production and food handling areas. For the latest updates on which Haneco products are certified, visit [haneco.com.au/news/fresh-haccp-food-grade-approval/](http://haneco.com.au/news/fresh-haccp-food-grade-approval/)



## Govt. Rebates

In the interests of reducing energy consumption in Victoria, New South Wales and South Australia the installation of approved new LED lighting is subsidised. The SA scheme is called REES, Victoria's is VEET and NSW has VEU (aka ESS). This effectively reduces the cost of installing energy efficient lights. For the latest updates on which Haneco products are certified, visit [haneco.com.au/resources/government-schemes/](http://haneco.com.au/resources/government-schemes/)



# PRODUCT INDEX

DOWNLIGHTS	SAP CODE	PRODUCT CODE	PAGE
AURORA 80 7W	2000046	AURORA80A01	21
AURORA 80 7W	2000047	AURORA80A02	21
AURORA SQUARE 13W Shoplight 3000K	2000053	AURORASQ115A01	39
AURORA SQUARE 13W Shoplight 5000K	2000054	AURORASQ115A02	39
AURORA SQUARE 18W Shoplight 5000K	2000056	AURORASQ150A02	39
AURORA SQUARE 26W Shoplight 4000K	2000058	AURORASQ190A4K	39
AURORA SQUARE 26W Shoplight 5000K	2000057	AURORASQ190A02	39
AURORA SQUARE 28W Shoplight 3000K	2000059	AURORASQ220A01	39
AURORA SQUARE 28W Shoplight 4000K	2000061	AURORASQ220A4K	39
AURORA SQUARE 28W Shoplight 5000K	2000060	AURORASQ220A02	39
AURORA Tritone 12W Black Trim	2001080	AURORA12W110-N-TRI	23
AURORA Tritone 12W Nickel Trim	2001079	AURORA12W10-B-TRI	23
AURORA Tritone 12W White Trim	2000849	AURORA12W110-W-TRI	23
AURORA Tritone 9W Black Trim	2001077	AURORA9W110-B-TRI	23
AURORA Tritone 9W Nickel Trim	2001078	AURORA9W110-N-TRI	23
AURORA Tritone 9W White Trim	2000850	AURORA9W110-W-TRI	23
AURORA Tritone Adaptor Ring 130MM	2000455	TRIM-AURORAV2-130-W	23
AURORA Tritone Adaptor Ring 170MM	2000456	TRIM-AURORAV2-170-W	23
CEDAR 40W Shoplight 4000K	2000534	D40W242*150RE4K90DF	41
CEDAR 40W Shoplight 5000K	2000536	D40W242*150RE5K90DF	41
CEDAR SNORKEL 38W Shoplight 4000K	2000151	D38W195R4K60DF	36
CENTAURI 10W/15W	2001195	C10/15W150R-MULTI	33
CENTAURI 15W/25W	2001087	C15/25W190R-MULTI	33
CENTAURI 20W/30W	2000576	C20/30W230R-MULTI	33
CENTAURI Adaptor Ring 280MM	2001219	TRIM-C2030-280-W	33
DETAIL 9W Black Adjustable 3000K	2000584	D9W110R3KBKIP65	28
DETAIL 9W Black Adjustable 4000K	2000160	D9W110R4KBKIP65	28
DETAIL 9W Black Adjustable 5000K	2000585	D9W110R5KBKIP65	28
DETAIL 9W White Adjustable 3000K	2000159	D9W110R3KWIP65	28
DETAIL 9W White Adjustable 4000K	2000161	D9W110R4KWIP65	28
DETAIL 9W White Adjustable 5000K	2000164	D9W110R5KWIP65	28
DIONE 15W Black Adjustable 3000K	2000144	D15W109R3KS	29
DIONE 15W White Adjustable 3000K	2000145	D15W109R3KW	29
DULAR Adjustable 9W	2001856	DULAR-ADJ-TRI	27
DULAR Fixed 9W	2001850	DULAR-FIX-TRI	26

DOWNLIGHT (continued)	SAP CODE	PRODUCT CODE	PAGE
MARS 20W 4000k	2000336	MARS20W160R4K	34
MARS 30W 4000k	2000338	MARS30W190R4K	34
MARS 40W 4000k	2000340	MARS40W215R4K	34
STELLAR 15W Adjustable 4000K	2000434	STELLAR120A4K	35
STELLAR 20W Adjustable 4000K	2000436	STELLAR145A4K	35
STELLAR 30W Adjustable 4000K	2000438	STELLAR170A4K	35
STELLAR 40W Adjustable 4000K	2000439	STELLAR190A4K	35
STELLAR 60 3W 3000K	2000440	STELLAR60A01	25
STELLAR 60 3W 4000K	2000442	STELLAR60A4K	25
STELLAR 60 3W 6000K	2000441	STELLAR60A02	25
VIVA 115 Adaptor Ring 130MM	2001878	TRIM-VIVA-130	18, 19
VIVA 115 Adaptor Ring 170MM	2001877	TRIM-VIVA-170	18, 19
VIVA 115 Clip-on Trim Black	2001875	TRIM-VIVA-GLD	18
VIVA 115 Clip-on Trim Gold	2001874	TRIM-VIVA-BLK	18
VIVA 115 Clip-on Trim Nickel	2001876	TRIM-VIVA-NKL	18
VIVA 115 Flush 8W Downlight	2001847	VIVA-FL-TRI	18
VIVA 115 Recessed 8W	2001846	VIVA-RC-TRI	19
VIVA Multi 90 7W	2000690	VIVA90-MULTI	17
VIVA Multi 90 Clip-on Trim Black	2001058	TRB-VIVA90	17
VIVA Multi 90 Clip-on Trim Nickel	2000894	TRN-VIVA90	17
VIVA145 14W Tritone	2001103	VIVA145-TRI	20
XBOX 10W Single Head	2000520	D10W112*112RE3KW	40
XBOX 15W Single Head	2000522	D15W176*176RE3KW	40
XBOX 20W Twin Head	2000527	D20W200*112RE3KW	40
XBOX 30W Triple Head	2000529	D30W280*112RE3KW	40
XBOX 30W Twin Head	2000531	D30W320*176RE3KW	40

SURFACE MOUNT	SAP CODE	PRODUCT CODE	PAGE
DISCUS 32W	2000120	CL32W300R3K120DF	57
METEOR 15W Black 3000K 45° Beam Angle	2000330	M15W90R3K45DC-B	49
METEOR 15W Black 4000K 45° Beam Angle	2000331	M15W90R4K45DC-B	49
METEOR 15W White 3000K 45° Beam Angle	2000329	M15W90R3K45DC	49
METEOR 15W White 4000K 45° Beam Angle	2000332	M15W90R4K45DC-W	49
METEOR 15W White 4000K 60° Beam Angle	2001661	M15W160R3K60DC	49
METEOR 35W Black 3000K 60° Beam Angle	2000647	M35W160R3K60DC-B	49
METEOR 35W Black 4000K 60° Beam Angle	2000334	M35W160R4K60DC-B	49
METEOR 35W White 3000K 60° Beam Angle	2000729	M35W160R3K60DC	49
METEOR 35W White 4000K 60° Beam Angle	2000333	M35W160R4K60DC	49
PLUTO 25W Tritone	2000116	CL25W400WP-MUL	55

SURFACE MOUNT (continued)	SAP CODE	PRODUCT CODE	PAGE
PLUTO 25W Tritone Intellisensor	2000119	CL25W400WP-MUL-SS	55,181
PLUTO Tritone Emergency	2000117	CL25W400WP-MUL-EM	55,165
PLUTO Tritone Intellisensor Emergency	2000118	CL25W400WP-MUL-EM-SS	55,165,181
PURO 350 21W 4000K	2000107	CL21W350R4K120DF	56
PURO 350 21W 5000K	200108	CL21W350R5K120DF	56
PURO 400 15W Tritone	2000103	CL15W300R-MULTI	53
PURO 400 25W Tritone	2000112	CL25W400R-MULTI	53
PURO 400 25W Tritone Intellisensor	2000111	CL25W400R-MUL-SS	53, 180
PURO 400 Tritone Emergency	2000113	CL25W400R-MULTI-EM	53, 164
PURO 400 Tritone Intellisensor Emergency	2000110	CL25W400R-MUL-EM-SS	53,164,180
TRACKLIGHT & LED STRIP	SAP CODE	PRODUCT CODE	PAGE
FLEXION 50M High Intensity IP20 Cool White	2001048	FS15W1MCW-IP20x50M	69
FLEXION 50M High Intensity IP20 Neutral White	2001049	FS15W1MNW-IP20x50M	69
FLEXION 50M High Intensity IP20 Warm White	2001050	FS15W1MWW-IP20x50M	69
FLEXION 50M Medium Intensity IP20 Cool White	2001045	FS8W1MCW-IP20x50M	69
FLEXION 50M Medium Intensity IP20 Neutral White	2001046	FS8W1MNW-IP20x50M	69
FLEXION 50M Medium Intensity IP20 Warm White	2001047	FS8W1MWW-IP20x50M	69
FLEXION 50M RGB 15W IP20		FS15W5MRGB60-IP20x50M	71
FLEXION 50M RGB 8W IP20		FS8W5MRGB30-IP20x50M	71
FLEXION 5M High Intensity IP20 Cool White	2000219	FS75W5MCW-IP20	68
FLEXION 5M High Intensity IP20 Neutral White	2000221	FS75W5MNW-IP20	68
FLEXION 5M High Intensity IP20 Warm White	2000223	FS75W5MWW-IP20	68
FLEXION 5M High Intensity IP65 Cool White	2000220	FS75W5MCW-IP65	68
FLEXION 5M High Intensity IP65 Neutral White	2000222	FS75W5MNW-IP65	68
FLEXION 5M High Intensity IP65 Warm White	2000224	FS75W5MWW-IP65	68
FLEXION 5M Low Intensity IP20 Cool White	2000199	FS25W5MCW-IP20	68
FLEXION 5M Low Intensity IP20 Cool White	2001042	FS5W1MCW-IP20x50M	69
FLEXION 5M Low Intensity IP20 Neutral White	2000201	FS25W5MNW-IP20	68
FLEXION 5M Low Intensity IP20 Neutral White	2001043	FS5W1MNW-IP20x50M	69
FLEXION 5M Low Intensity IP20 Warm White	2000203	FS25W5MWW-IP20	68
FLEXION 5M Low Intensity IP20 Warm White	2001044	FS5W1MWW-IP20x50M	69
FLEXION 5M Low Intensity IP65 Cool White	2000200	FS25W5MCW-IP65	68
FLEXION 5M Low Intensity IP65 Neutral White	2000202	FS25W5MNW-IP65	68
FLEXION 5M Low Intensity IP65 Warm White	2000204	FS25W5MWW-IP65	68
FLEXION 5M Medium Intensity IP20 Cool White	2000210	FS40W5MCW-IP20	68
FLEXION 5M Medium Intensity IP20 Neutral White	2000212	FS40W5MNW-IP20	68
FLEXION 5M Medium Intensity IP20 Warm White	2000214	FS40W5MWW-IP20	68
FLEXION 5M Medium Intensity IP65 Cool White	2000211	FS40W5MCW-IP65	68
FLEXION 5M Medium Intensity IP65 Neutral White	2000213	FS40W5MNW-IP65	68

TRACKLIGHT & LED STRIP (continued)	SAP CODE	PRODUCT CODE	PAGE
FLEXION 5M Medium Intensity IP65 Warm White	2000215	FS40W5MWW-IP65	68
FLEXION 5M RGB 40W IP54	2001480	FS40W5MRGB30-IP54	70
FLEXION 5M RGB 75W IP54	2001472	FS75W5MRGB60-IP54	70
FLEXION Controller to RGB Strip Connector		FLEX-CTRL-RGB	75
FLEXION Dimmable Driver 200W IP67	2000830	HD-0200-24V	72
FLEXION Dimmable Driver 25W IP20	2000818	HD-0025-24V	72
FLEXION Dimmable Driver 50W IP20	2000829	HD-0050-24V	72
FLEXION Driver 100W IP67	2000613	HN-0100-24V	72
FLEXION Driver 150W IP67	2000616	HN-0150-240V	72
FLEXION Driver 240W IP67	2000265	HN-0240-24V	72
FLEXION Driver 40W IP20	2000918	HN-0040-24V	72
FLEXION Driver 75W IP20	2000988	HN-0074-24V	72
FLEXION Driver 75W IP65	2000611	HN-0075-24V-IP65	72
FLEXION IP20 & IP65 150MM Strip to Power Connector		FLEXS-P10MM	74
FLEXION IP20 & IP65 150MM Strip to Strip Connector		FLEXS-P10MM	74
FLEXION IP20 & IP65 5MM Strip to Power Connector		FLEXS-P5MIP20	74
FLEXION IP20 & IP65 Angle Joiner		FLEXCNR	74
FLEXION IP20 & IP65 Cable		FLEXCBL30M	74
FLEXION IP20 & IP65 Joiner		FLEXJNR	74
FLEXION IP20 & IP65 Male To		FLEXMFC	74
FLEXION IP65 Saddles		FLEXSDL	73
FLEXION IP65 Sealer		FLEXSEALER	73
FLEXION IP65 Terminal		FLEXCOVER	73
FLEXION RGB Angle Joiner		FLEXCNR-RGB	75
FLEXION RGB Joiner		FLEXJNR-RGB	75
FLEXION RGB Strip to Wire Connector		FLEX-WIRE-RGB	75
FOCI 180° Flexible Track Bracket Black	2000414	SMTCH-BK-FD	65
FOCI 180° Flexible Track Bracket White	2000419	SMTCN-WH-FD	65
FOCI 180° Simple Fit Bracket Black	2000411	SMTCN-BK-180D	64
FOCI 180° Simple Fit Bracket White	2000416	SMTCN-WH-180D	64
FOCI 240V Initial Feed Black	2000415	SMTCN-BK-INTFEED	64
FOCI 240V Initial Feed White	2000420	SMTCN-WH-INTFEED	64
FOCI 25W 3000K Black	2001335	FOCI25W-B3KTRK	63
FOCI 25W 4000K Black	2001337	FOCI25W-B4KTRK	63
FOCI 25W 3000K White	2001336	FOCI25W-W3KTRK	63
FOCI 25W 4000K White	2001338	FOCI25W-W4KTRK	63
FOCI 3 Circuit Track Black 1M	2000400	SMFWT-BK-1M	64
FOCI 3 Circuit Track Black 3M	2000401	SMFWT-BK-3M	64
FOCI 3 Circuit Track White 1M	2000402	SMFWT-WH-1M	64
FOCI 3 Circuit Track White 3M	2000403	SMFWT-WH-3M	64



TRACKLIGHT & LED STRIP (continued)	SAP CODE	PRODUCT CODE	PAGE
FOCI 90° Simple Fit Bracket Black	2000412	SMTCN-BK-90D	64
FOCI 90° Simple Fit Bracket White	2000417	SMTCN-WH-90D	64
FOCI Beam Adjustable Kit 15°	2001380	FOCI-RF15D	65
FOCI Beam Adjustable Kit 24°	2001381	FOCI-RF24D	65
FOCI End Cap Black	2000413	SMTCN-BK-ENDCAP	64
FOCI End Cap White	2000418	SMTCN-WH-ENDCAP	64
FOCI Suspension Kit Black	2000446	SUSPENSION-KIT-BK	65
FOCI Suspension Kit White	2000447	SUSPENSION-KIT-WH	65
PARALLAX 180° Wide Beam 20MM	2000999	PARALLAX20X20SQ2M	76
PARALLAX Corner 23MM Round Face	2001009	PARALLAXCNR23RD2M	77
PARALLAX Low Profile 17MM Face	2000995	PARALLAX17X8LP2M	76
PARALLAX Recessed 23MM Face	2001001	PARALLAX23REC2M	77
PARALLAX Square 17MM Face	2000997	PARALLAX17X15SQ2M	76
BATTEN	SAP CODE	PRODUCT CODE	PAGE
ATEN 1200MM	2001884	ATEN-LK12	85
ATEN 300MM		ATEN-LK03	85
ATEN 600MM	2001883	ATEN-LK06	85
ATEN 900MM		ATEN-LK09	85
BARE BATTEN Single Tube	2000375	SDB1200	93
BARE BATTEN Twin Tube	2000452	TDB1200	93
BLADE 1200MM 4K	2000075	BLADE40W12SM-4K	92
BLADE 1200mm 6K	2000076	BLADE40W12SM-6K	92
BLADE 600MM 4K	2000071	BLADE20W06SM-4K	92
BLADE 600MM 6K	2000073	BLADE20W06SM-6K	92
DURALITE 1200MM	2001498	DURALITE18/36W12	97
DURALITE 1200MM Emergency	2001499	DURALITE18/36W12-EM	97,161
DURALITE 600MM	2001496	DURALITE20W06	97
DURALITE 600MM Emergency	2001497	DURALITE20W06-EM	97,161
OXFORD 1200MM	2001885	OXFORD12	91
OXFORD 1200MM Emergency	2001886	OXFORD12-EM	91
OXFORD 1200MM Intellisensor	2001887	OXFORD12-SS	91
OXFORD 1200MM Intellisensor Emergency	2001888	OXFORD12-EM-SS	91
SENTRY 600MM	2001495	SENTRY12W06-TRI	101
TRIPROOF 1200MM	2001168	TRIPROOF20/40W12-TRI	99
TRIPROOF 1200MM Emergency	2001066	TRIPROOF20/40W12-TRI-EM	99,163
TRIPROOF 1200MM Intellisensor	2001067	TRIPROOF40W12-TRI-SS	99,183
TRIPROOF 1200MM Intellisensor Emergency	2001068	TRIPROOF40W12-TRI-SS-EM	99,163,183
TRIPROOF 1500MM	2001170	TRIPROOF60W15-TRI	100

BATTEN (continued)	SAP CODE	PRODUCT CODE	PAGE
TRIPROOF 1500MM Emergency	2001171	TRIPROOF60W15-TRI-EM	100,163
TRIPROOF 600MM	2001164	TRIPROOF20W06-TRI	99
TRIPROOF 600MM Emergency	2001165	TRIPROOF20W06-TRI-EM	99,163
VISTA 1200MM Tritone	2001161	VISTA20/40W12-TRI	89
VISTA 1200MM Tritone Emergency	2001063	VISTA20/40W12-TRI-EM	89,159
VISTA 1200MM Tritone Intellisensor	2001064	VISTA40W12-TRI-SS	89,182
VISTA 1200MM Tritone Intellisensor Emergency	2001065	VISTA40W12-TRI-SS-EM	89,159,182
VISTA 600MM Tritone	2001157	VISTA20W06-TRI	89
VISTA 600MM Tritone Emergency	2001158	VISTA20W06-TRI-EM	89,159
VISTALITE 1200MM Tritone	2001633	VSL20W40W12-TRI	87
VISTALITE 1200MM Tritone Emergency	2001635	VSL20W40W12-TRI-EM	87,160
VISTALITE 600MM Tritone	2001630	VSL20W06-TRI	87
VISTALITE 600MM TritoneEmergency	2001631	VSL20W06-TRI-EM	87,160
PANEL	SAP CODE	PRODUCT CODE	PAGE
GALAXY 18W 300 x 300 5K	2000602	GALAXY0303-5K	112
GALAXY 25W 300x x1200 4K	2001854	GALAXY25W0312-4K	112
GALAXY 25W 300x x1200 5K	2001855	GALAXY25W0312-5K	112
GALAXY Plaster Recess Frame 400 x 1200	2001091	RF0412-AF	113
GALAXY Plaster Recess Frame 595 x x1195	2000410	RF0612-AF	113
GALAXY Surface Mount Frame 300 x 300	2000404	SMPF0303	113
GALAXY Suspension Kit 1M	2001233	PSSKIT-1M-6PCS	113
GALAXY Suspension Kit 2M	2001234	PSSKIT-2M-6PCS	113
MATRIX 18W 300 x 300 4K	2001842	MATRIX18W0306-4K	108
MATRIX 18W 300 x 300 5K	2001843	MATRIX18W0306-5K	108
MATRIX 28W 300 x 1200 4K	2001862	MATRIX28W0312-4K	108
MATRIX 28W 300 x 1200 5K	2001863	MATRIX28W0312-5K	108
MATRIX 28W 600 x 600 4K	2001842	MATRIX28W0606-4K	108
MATRIX 28W 600 x 600 5K	2001843	MATRIX28W0606-5K	108
MATRIX 36W 300 x 1200 4K	2000341	MATRIX36W0312-4K	108
MATRIX 36W 300 x 1200 5K	2000342	MATRIX36W0312-5K	108
MATRIX 36W 600 x 600 4K	2000343	MATRIX36W0606-4K	108
MATRIX 36W 600 x 600 6K	2000344	MATRIX36W0606-5K	108
MATRIX 48W 600 x 1200 4K	2001851	MATRIX48W0612-4K	108
MATRIX 48W 600 x 1200 5K	2001852	MATRIX48W0612-5K	108
MATRIX Plaster Recess Frame 330 x 1230	2000358	PLRF0312	109, 113
MATRIX Plaster Recess Frame 330 x 330	2000356	PLRF0303	113
MATRIX Plaster Recess Frame 330 x 630	2000357	PLRF0306	109

PANEL (continued)	SAP CODE	PRODUCT CODE	PAGE
MATRIX Plaster Recess Frame 630 x 1230	2000360	PLRF0612	109
MATRIX Plaster Recess Frame 630 x 630	2000359	PLRF0606	109
MATRIX Single Piece Frame	2001881	SMPF0312-OP-V2	109, 113
MATRIX Surface Mount Frame 300 x 1200	2000406	SMPF0312	109
MATRIX Surface Mount Frame 300 x 600	2000405	SMPF0306	109, 113
MATRIX Surface Mount Frame 600 x 1200	2000409	SMPF0612	109
MATRIX Surface Mount Frame 600 x 600	2000408	SMPF0606	109
MATRIX Suspension Kit 0.6M - 2.6M	2001880	SUSKIT-MATRIX	109
MATRIX Vented Plaster Recess Frame 400 x 1200	2001091	PF0412-AF	109
MATRIX Vented Plaster Recess Frame 595 x 1195	2000410	PF0612-AF	109
HIGHBAY & LOWBAY	SAP CODE	PRODUCT CODE	PAGE
HOODIE	2001240	HOODIE80WS	127
KASTA 1-10v Dimmer	5000012	D1-10VIBH	122
KASTA Daylight Sensor	5000011	SL02AB-BH	122
MERIDIAN	2000990	MERID120W30X70	128
MERIDIAN	2000991	MERID120W40X130	128
MERIDIAN	2000992	MERID160W30X70	128
MERIDIAN	2000993	MERID160W40X130	128
SKYCUBE	2000380	SKYCUBE120W-IP65	131
SKYCUBE	2000381	SKYCUBE180W	131
SKYCUBE	2000656	SKYCUBE180W-OP	131
SKYPAD	2000881	SKYPAD120W-10VDIM	120
SKYPAD	2000390	SKYPAD150W-10VDIM	120
SKYPAD	2000908	SKYPAD200W-V2	120
SKYPAD Diffuser	2000350	PCD-SKYPAD	125
SKYPAD Extension Bracket	2000196	FL-SKYPADKIT	123
SKYPAD Intellisensor	2001118	MC031V	121
SKYPAD Metal Reflector	2000292	HRPAD90DB	124
SKYPAD Prismatic Reflector Enclosed	2000817	SKYPAD-PRSDIF-EN	124
SKYPAD Prismatic Reflector Open	2000396	SKYPAD-PRSDIF	124
SKYPAD Sumax Bracket	2000891	SUNMAX-BRKT	121
SKYPAD Sunmax Smart Control	2000878	SUNMAX-50MA-W-IP20	121
SKYPAD Surface Mount Kit	2000395	SKYPAD-FGSMK001	123
SKYPAD Wireguard	2000399	SKYPAD-WIREGUARD	125
SUPERNOVA	2000766	SN80WS	126

EXTERIOR LIGHTING	SAP CODE	PRODUCT CODE	PAGE
ARCHISPOT 12W Up/Down Black	2001538	ASU/D12W60-B-3K	148
ARCHISPOT 12W Up/Down Silver	2001479	ASU/D12W60-S-3K	148
ARCHISPOT 6W Adjustable Black	2001818	ASADJ6W60-B-3K	148
ARCHISPOT 6W Adjustable Silver	2001478	ASADJ6W60-S-3K	148
ARCHISPOT 6W Fixed Black	2001817	ASFIX6W60-B-3K	148
ARCHISPOT 6W Fixed Silver	2001477	ASFIX6W60-S-3K	148
CALEO 30W 5000K	2000697	CALEO30W-5K	146
CALEO 30W Microwave Motion Sensor 5000K	2000698	CALEO30W-5K-S	146
DAWN 16W Oval Tritone	2001706	DN16WOVL-TRI	145
DAWN 16W Oval Tritone Emergency		DN16WOVL-TRI-EM	145,167
DAWN 20W Round Tritone	2001699	DN20WRND-TRI	145
DAWN 20W Round Tritone Emergency		DN20WRND-TRI-EM	145,167
DAWN 30W Round Tritone	2001700	DN30WRND-TRI	145
DAWN 30w Round Tritone Emergency		DN30WRND-TRI-EM	145,167
MATITA 12W Bollard	2000542	G12W120*650R3K52DC-BK	167
PARX	2000886	PARX150W-ASYM	140
PARX	2000851	PARX200W-ASYM	140
PARX	2001092	PARX300W-ASYM	140
PARX Glare Shield		PARX-65	141
PARX Side Mount Bracket		PARX-PDLEM	141
PARX Top Mount Bracket		PARX-TENON	141
PARX Wire Guard		PARX -WG	141
PROXIMA 10W 5000K 1P	2001590	PROXIMA10W1P-B5K	147
PROXIMA 10W 5000K 2P	2001112	PROXIMA10W1P-B5K-S	147
PROXIMA 20W 5000K 1P	2001591	PROXIMA20W2P-B5K	147
PROXIMA 20W 5000K 2P	2001113	PROXIMA20W2P-B5K-S	147
STAX 100W	2001652	STAX100WB5K	138
STAX 10W	2001647	STAX10WB5K	138
STAX 10W PIR Motion Sensor	2001858	STAX10WB5K-S	139
STAX 140W	2001653	STAX140WB5K	138
STAX 180W	2001654	STAX180WB5K	138
STAX 20W	2001648	STAX20WB5K	138
STAX 20W PIR Motion Sensor	2001859	STAX20WB5K-S	139
STAX 30W	2001649	STAX30WB5K	138
STAX 30W PIR Motion Sensor	2001860	STAX30WB5K-S	139
STAX 50W	2001650	STAX50WB5K	138
STAX 50W PIR Motion Sensor	2001861	STAX50WB5K-S	139
STAX 75W	2001651	STAX75WB5K	138



EXTERIOR LIGHTING (Continued)	SAP CODE	PRODUCT CODE	PAGE
WALL WASHER 12W Black 3000K	2000549	W12W150*90RE3KB	149
WALL WASHER 12W Black 3000K	2000552	W12W150*90RE4KB	149
WALL WASHER 12W Black 4000K	2000555	W12W150*90RE6KW	149
WALL WASHER 12W Grey 3000K	2000550	W12W150*90RE3KG	149
WALL WASHER 12W Grey 4000K	2000553	W12W150*90RE4KW	149
WALL WASHER 12W White 3000K	2000551	W12W150*90RE3KW	149
WALL WASHER 12W White 4000K	2000554	W12W150*90RE6KB	149
EMERGENCY LIGHTING	SAP CODE	PRODUCT CODE	PAGE
DAWN 16W Oval Tritone Emergency		DN16WOVL-TR-EM	129
DAWN 20W Round Tritone Emergency		DN20WRND-TRI-EM	129
DAWN 30W Round Tritone Emergency		DN30WRND-TRI-EM	129
DURALITE 1200MM Emergency	2001499	DURALITE18/36W12-EM	97, 123
DURALITE 600MM Emergency	2001497	DURALITE20W06-EM	97, 123
LUME Recessed Black D63	2001872	LUME3WD63-BK	119
LUME Recessed White D32	2001059	LUME1W110EM2HR	119
LUME Recessed White D63	2001853	LUME3WD63	119
LUME Surface Mount Black D63	2001873	LUME3WD63-SM-BK	119
LUME Surface Mount Kit	2001870	SM-ENC-DL	119
LUME Surface Mount White D63	2001869	LUME3WD60-SM	119
LUME Suspension Kit	2001871	SM-ENC-SUSKIT	119
PLUTO Tritone Emergency	2000117	CL25W-400WP-MUL-EM	127
PLUTO Tritone Intellisensor Emergency	2000118	CL25W-400WP-MUL-EM-SS	127
PURO 400 Tritone Emergency	2000113	CL25W400WP-MUL-EM	125
PURO 400 Tritone Intellisensor Emergency	2000110	CL25W400WP-MUL-EM-SS	124
TRIPROOF 1200MM Emergency	2001066	TRIPROOF20/40W12-TRI-EM	125
TRIPROOF 1200MM Intellisensor Emergency	2001068	TRIPROOF40W12-TRI-SS-EM	125
TRIPROOF 1500MM Emergency	2001171	TRIPROOF60W15-TRI-EM	125
TRIPROOF 600MM Emergency	2001165	TRIPROOF20W06-TRI-EM	125
VISTA 1200MM Emergency	2001063	VISTA20/40W12-TRI-EM	89, 121
VISTA 1200MM Intellisensor Emergency	2001065	VISTA40W12-TRI-SS-EM	89, 121
VISTA 600MM Emergency	2001158	VISTA20W06-TRI-EM	89, 121
VISTALITE 1200MM Emergency	2001635	VSL20W40W12-TRI-EM	87, 122
VISTALITE 600MM Emergency	2001631	VSL20W06-TRI-EM	87, 122
RETRO FIT	SAP CODE	PRODUCT CODE	PAGE
LED TUBE 7W 600MM 6500K	2001135	LEDTUBE7W06-6K	173
LED TUBE 11W 1200MM 4000K		LEDTUBE10W12-4K	173
LED TUBE 11W 1200MM 6500K		LEDTUBE10W12-6K	173
PAR 38 E27 5000K	2000821	PAR15W38-5K	172

RETRO FIT (continued)	SAP CODE	PRODUCT CODE	PAGE
RETRO 7W KIT 3K	2000890	RETRO7WRF-3K	170
RETRO 7W KIT 5K	2000747	RETRO7WRF-5K	170
RETRO 7W KIT Trim Round Chrome	2000260	HHG108A	170
RETRO 7W KIT Trim Round White	2000261	HHG108B	170
RETRO 7W KIT Trim Square Silver	2000259	HHG100SQB	170
RETRO A60 B22 3000K	2000066	B9W60R3KB22	171
RETRO A60 B22 6500K	2000068	B9W60R6KB22	171
RETRO A60 E27 3000K	2000067	B9W60R3KE27	171
RETRO A60 E27 6500K	2000069	B9W60R6KE27	171
LIGHTING CONTROL	SAP CODE	PRODUCT CODE	PAGE
DUO 350 Dimmer	2001203	DUO350W-W	176
DUO 350 Black Knob	2001214	DUO-KNOB-BK	176
SENTURA	2001528	SENTURA-SMPIR360	177
PURO 400 25W Tritone Intellisensor	2000111	CL25W400R-MUL-SS	53, 180
PURO 400 Tritone Intellisensor Emergency	2000110	CL25W400R-MUL-EM-SS	53,164,180
PLUTO 25W Tritone Intellisensor	2000119	CL25W400WP-MUL-SS	55,181
PLUTO Tritone Intellisensor Emergency	2000118	CL25W400WP-MUL-EM-SS	55,165,181
VISTA 1200MM Tritone Intellisensor	2001064	VISTA40W12-TRI-SS	89,182
VISTA 1200MM Tritone Intellisensor Emergency	2001065	VISTA40W12-TRI-SS-EM	89,159,182
TRIPROOF 1200MM Intellisensor	2001067	TRIPROOF40W12-TRI-SS	99,183
TRIPROOF 1200MM Intellisensor Emergency	2001068	TRIPROOF40W12-TRI-SS-EM	99,163,183
SECURITY	SAP CODE	PRODUCT CODE	PAGE
AGILIS		AG300	191
SMOXE	2001464	SMOXE240V-B1YHW	190
SMOXE Connector Base	2000845	SMOXE240V-518TBOX-SLEEVE	190

Haneco Lighting is constantly developing and improving its products. All descriptions, illustrations, drawings and specifications in this publication present only general particulars and shall not form part of any contract. The right is reserved to change specifications without prior notification or public announcement. All goods supplied by the company are supplied subject to the company's General Conditions of Sale, a copy of which is available on request. All measurements are in millimetres and weights in kilograms unless otherwise stated.

## **South Australia (Head Office)**

262 Marion Road  
Netley, SA 5037  
Ph: (08) 8297 6373  
Fax: (08) 8297 6769

## **New South Wales & ACT**

Unit 3, 40 Brodie Street  
Rydalmere, NSW 2116  
Ph: 02 8999 1377

## **Queensland**

72 Crockford St  
Northgate, QLD 4013  
Ph: 07 3123 5008  
Fax: 07 3319 6170

## **Victoria & Tasmania**

Building 8, 163-179 Forster Road  
Mount Waverley, VIC 3149  
Ph: 03 9008 6109  
Fax: 03 8524 3095

## **Western Australia**

4/8 Tomlinson Road  
Welshpool, WA 6106  
Ph: 08 9436 6666  
\* Pick up only

## **GENERAL ENQUIRIES**

info@haneco.com.au  
Ph: (08) 8297 6373

**1300 001 LED (533)**  
**www.haneco.com.au**

#hanecolighting  
@hanecolighting





Australia's LED Lighting Specialist.



