

HESPERUS™ Series

Unison™
Powerpoint

H1PPH



Double horizontal powerpoint

FEATURES

- Slim (9.8mm plate depth), contemporary, glass-look design
- UV stabilised to avoid discolouring
- Fits standard first fix mounting accessories (e.g. C-clips, nail brackets, wall boxes)
- Flush mounting centres (not recessed) for quicker installation
- Deep guided cable terminals allow for fast fitment of cables
- Multiple mounting facilities at both 84mm and 100mm, along with corner fixing points
- Colour coded terminals for ease of identification
- Suitable for loads that use plugs with two or three flat pins
- 5 year warranty

CONNECTION

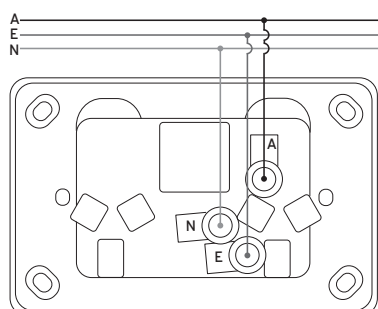

SPECIFICATIONS

Power Supply	220-240V a.c.
Operating Ambient Temperature	-20 to 40°C
IP Rating	IP20
Current Rating	10A
Plate Depth	9.8mm
Terminal Size	16mm ² (accommodates 4x2.5mm ² cables)
Terminal Screw Type	Combination Flat/Philips head
Mounting Points	84mm / 100mm and Corners
Mounting Screw Type	Combination Flat/Philips head
Frame Colour (Finish)	Black (Gloss)
Plate Colour (Finish)	White / Black (Transparent)
Housing Material	Acrylic / Polycarbonate (PC)
Standards Complied	AS/NZS 3112, AS/NZS 3100

ORDERING CODE

H1PPH-WH
 (plate finish)
 WH - White
 BK - Black

COLOURS



DIMENSIONS

