

# HANECO LIGHTING LED INSTALLATION GUIDE

## VIVA145-TRI

PRODUCT CODE: VIVA145-TRI

Product should be installed by a qualified electrician.  
Prior to installation ensure power is off at fuse box to prevent electrical shock.

### Contents

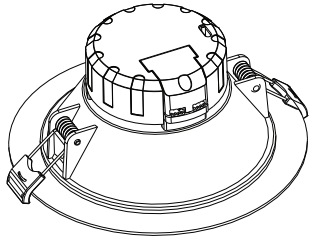

1

**Cut 125mm diameter hole. Ensure adequate clearance as described below.**

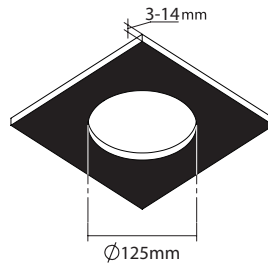

2

**Select desired colour temperature**

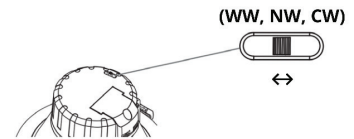

3

**Insert plug into socket**

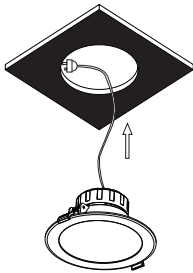

4

**Hold mounting clips up to sides of down light and insert into cut-out so that springs retract onto rear surface of ceiling**

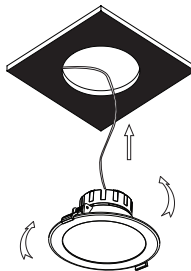

5

**Complete**

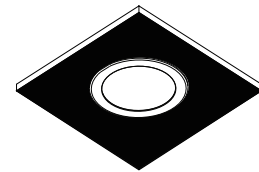

### Clearance Guidelines

Haneco lighting LED down light requires the minimum clearance around heat sink, including thermal insulation and building structural members to be at a minimum of 50mm. This clearance is based on maximum ambient temperature of 70°C.

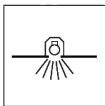

#### NON-IC

a recessed luminaire that can be used where normally flammable materials, including building insulation, are or maybe present, but cannot be abutted against any material and cannot be covered in normal use

Dimension	Clearance
A – Clearance above luminaire	150 mm
B – Side clearance to combustible building element	0 mm
C – Side clearance to bulk thermal insulation	50 mm

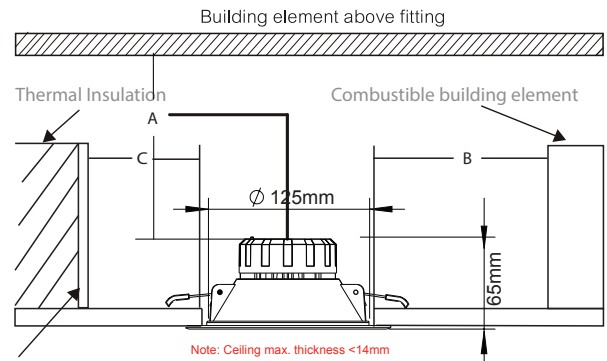

Fixed guard required where:  
-insulation materials are not secured in position  
-Loose materials are present

