

SKYPAD150W-SUN

QUICK FACTS

Input power	150W
Power Factor	≥0.9
IP Rating	67
Dimming	1-10V
Lumen output	21000lm
CCT	5000K
CRI	>80
Beam Angle	110°
Fascia Colour	Black
Installation	Suspended & Surface Mounted
Warranty	5 years

PRODUCT SPECIFICATIONS

Supply Voltage	240-265V
Supply Frequency	50-60Hz
Cable	2.5M Flex&Plug
Body	Aluminium
Diffuser	PC
Driver	Fixed Remote
Weight	G.W : 5.1kgs N.W : 4kgs
Ambient Temp	0°C - 45°C
Avg. lifetime	≥60,000 hrs@ ta 55°C

Accessory
Metal Reflector, Wire Guard, Frosted Diffuser, Prismatic Reflector

Option:
Intellisensor

PHOTO



PHOTOMETRIC DIAGRAM

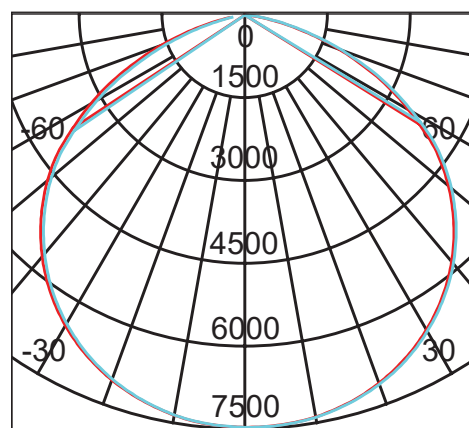

UNIT: cd

— C0/180 114.6deg

— C90/270 114.4deg

DIMENSIONS

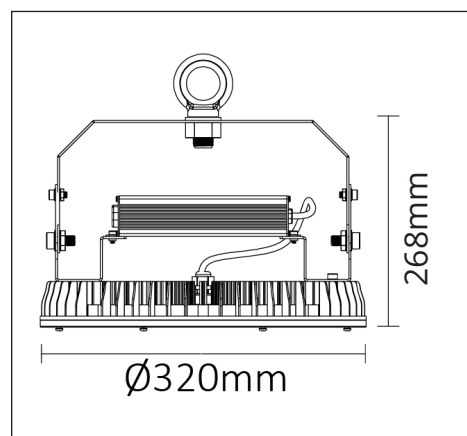

Subject to change without notice, errors and omission excepted. Always make sure to use the most recent release.

SKYPAD150W-SUN

QUICK FACTS

- Provides an energy saving without sacrificing visual comfort.
- Ambient light dependent control.
- Directly connected to 1-10V interface.
- Simple setting of target light level by means of potentiometer.

SPECIFICATIONS

Dimming Range	10-100%
Detection Angle	90°
Operating Temperature	0-45°C
IP Rating	IP20

Daylight sensor



The luminaire operates on 100% illumination or dims to maintain the preset illumination level against ambient light.

The lamp dims to minimum light level but won't switch off even if there is sufficient ambient light.

Users can switch off the light manually.

PHOTO

SKYPAD MOUNT



SURFACE MOUNT



TYPICAL WIRING DIAGRAM

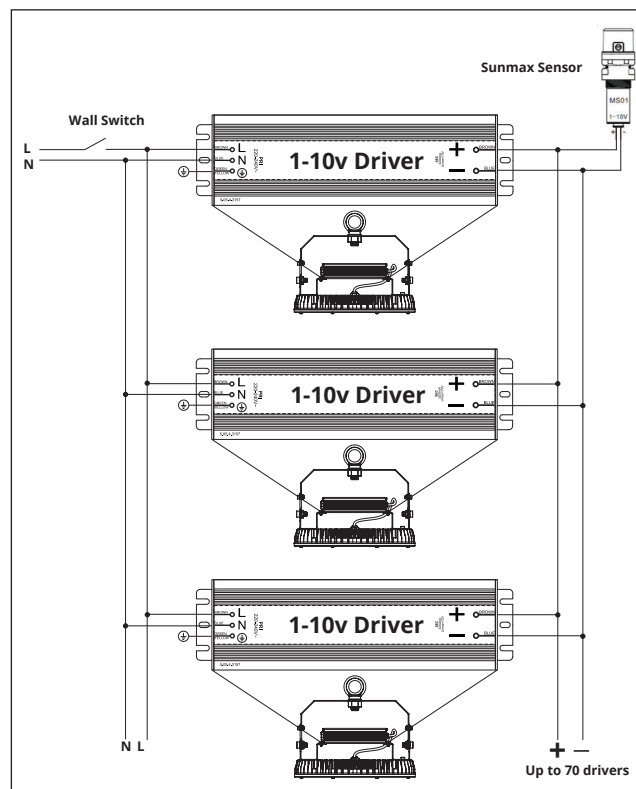

Subject to change without notice, errors and omission excepted. Always make sure to use the most recent release.