

LED LAMPS

A60	190
T40	192
GU10	194
MR16	196











Covers a diverse range of applications

Extensive model range

Provides the choice of light hues from a single luminaire

5CCT colour selectable*

Utilise existing enclosure to reduce energy consumption

LED retrofit design

Adjustable brightness to improve comfort

Dimmable driver*

A60

The perfect replacement.

Designed with versatility in mind, our A60 lamps seamlessly fit into any standard light fixture, making them the perfect choice for your existing lighting setup. Whether it's a living room, bedroom, office, or restaurant, our lamps effortlessly blend in and elevate the atmosphere of any space. With a wide range of colour temperatures and dimming options available, our A60 lamps allow you to create the perfect lighting mood for any occasion.

*Model dependent



TRITONE
Colour Selectable



IP20
Ingress Protection Rating



INSTALL
Easy Installation



1yr
Warranty

PRODUCT RANGE



Product Code	B4W60R-B22	B4W60R-E27	B8W60R-B22	B8W60R-E27
SAP Code	2002238	2002239	2002240	2002241
Power	4 W	4 W	8 W	8 W
Lumen Output	400 lm	400 lm	800 lm	800 lm
Efficacy	100±10% lm/W	100±10% lm/W	100±10% lm/W	100±10% lm/W
CCT	2700 / 3000 / 4000 / 5000 / 6000 K	2700 / 3000 / 4000 / 5000 / 6000 K	2700 / 3000 / 4000 / 5000 / 6000 K	2700 / 3000 / 4000 / 5000 / 6000 K
Connection Type	B22 Bayonet	E27 Edison Screw	B22 Bayonet	E27 Edison Screw
Dimensions	Ø60 x 115 mm	Ø60 x 115 mm	Ø60 x 115 mm	Ø60 x 115 mm
Weight	0.038 kg	0.038 kg	0.038 kg	0.038 kg
Beam Angle	180°	180°	180°	180°
Product Colour	White	White	White	White
Dimmable	Non-Dimmable	Non-Dimmable	Non-Dimmable	Non-Dimmable



Product Code	B10W60R-B22	B10W60R-E27	B12WD60R-B22	B12WD60R-E27
SAP Code	2002242	2002243	2002244	2002245
Power	10 W	10 W	12 W	12 W
Lumen Output	1000 lm	1000 lm	1200 lm	1200 lm
Efficacy	100±10% lm/W	100±10% lm/W	100±10% lm/W	100±10% lm/W
CCT	2700 / 3000 / 4000 / 5000 / 6000 K	2700 / 3000 / 4000 / 5000 / 6000 K	3000 / 4000 / 6000 K	3000 / 4000 / 6000 K
Connection Type	B22 Bayonet	E27 Edison Screw	B22 Bayonet	E27 Edison Screw
Dimensions	Ø60 x 115 mm	Ø60 x 115 mm	Ø60 x 109 mm	Ø60 x 109 mm
Weight	0.038 kg	0.038 kg	0.055 kg	0.055 kg
Beam Angle	180°	180°	150°	150°
Product Colour	White	White	White	White
Dimmable	Non-Dimmable	Non-Dimmable	Phase-Cut Dimmable (Trailing Edge, 10-100%)	Phase-Cut Dimmable (Trailing Edge, 10-100%)

COMMON SPECIFICATIONS

Body Material	Plastic and Aluminium
Diffuser Material	Polycarbonate (Opal)
IP Rating	IP20
CRI	> 80
SDCM	< 7
Driver	Linear
Input Voltage	220-240Vac, 50/60Hz

Electrical Classification	Class II
Power Factor	≥ 0.55
Protection	Overload / Short Circuit
Projected Lifespan	> 15,000hrs @Ta25°C
Operating Ambient Temperature	Ta25°C

APPLICATIONS

Bedrooms
Lounge Room
Dining Area
Kitchen / Food Prep
Butler Pantry
Hallways
Entrance
Staircase
Ensuite
Bathrooms
Walk-in Wardrobes

DIMENSIONS

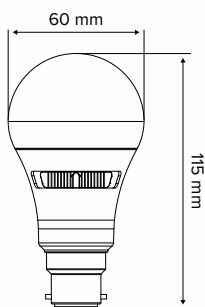

B4W60R-B22 /
B8W60R-B22 /
B10W60R-B22

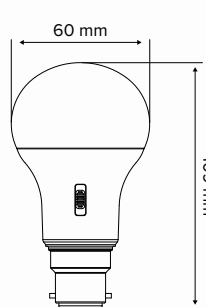

B12WD60R-B22

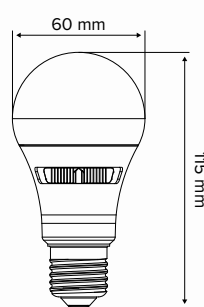

B4W60R-E27 /
B8W60R-E27 /
B10W60R-E27

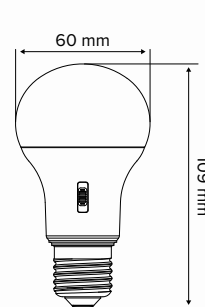

B12WD60R-E27

Find out more



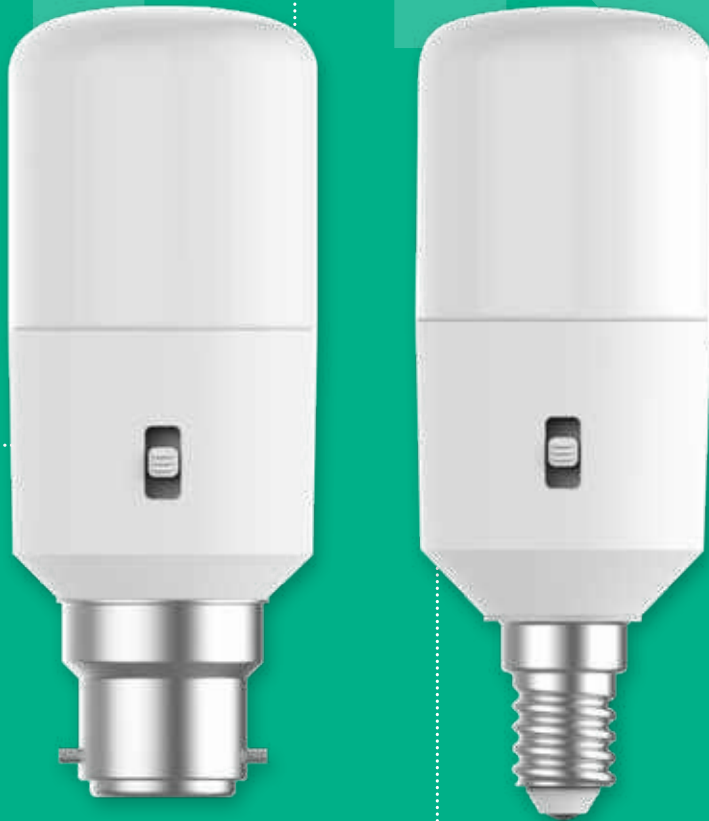

Covers a diverse range of applications

Extensive model range

Provides the choice of light hues from a single luminaire

Tritone colour selectable*

Utilise existing enclosure to reduce energy consumption

LED retrofit design

Adjustable brightness to improve comfort

Dimmable driver*

T40

The perfect replacement.

Designed with versatility in mind, our T40 tubular lamps seamlessly fit into any standard light fixture, making them the perfect choice for your existing lighting setup. Whether it's a living room, bedroom, office, or restaurant, our lamps effortlessly blend in and elevate the atmosphere of any space. With a wide range of colour temperatures and dimming options available, our T40 tubular lamps allow you to create the perfect lighting mood for any occasion.

*Model dependent



PRODUCT RANGE



Product Code	B7W40T-B15	B7W40T-E14	B9W40T-B22	B9W40T-E27
SAP Code	2002292	2002293	2002294	2002295
Power	7 W	7 W	9 W	9 W
Lumen Output	700 lm	700 lm	900 lm	900 lm
Efficacy	100±10% lm/W	100±10% lm/W	100±10% lm/W	100±10% lm/W
CCT	3000 / 4000 / 6000 K	3000 / 4000 / 6000 K	3000 / 4000 / 6000 K	3000 / 4000 / 6000 K
Connection Type	B15 Bayonet	E14 Edison Screw	B22 Bayonet	E27 Edison Screw
Dimensions	Ø40 x 110 mm	Ø40 x 110 mm	Ø40 x 107 mm	Ø40 x 107 mm
Weight	0.038 kg	0.038 kg	0.038 kg	0.038 kg
Beam Angle	170°	170°	170°	170°
Product Colour	White	White	White	White
Dimmable	Non-Dimmable	Non-Dimmable	Non-Dimmable	Non-Dimmable



Product Code	B9WD40T-B22	B9WD40T-E27
SAP Code	2002296	2002297
Power	9 W	9 W
Lumen Output	900 lm	900 lm
Efficacy	100±10% lm/W	100±10% lm/W
CCT	3000 / 4000 / 6000 K	3000 / 4000 / 6000 K
Connection Type	B22 Bayonet	E27 Edison Screw
Dimensions	Ø40 x 107 mm	Ø40 x 107 mm
Weight	0.045 kg	0.045 kg
Beam Angle	170°	170°
Product Colour	White	White
Dimmable	Phase-Cut Dimmable (Trailing Edge, 10-100%)	Phase-Cut Dimmable (Trailing Edge, 10-100%)

COMMON SPECIFICATIONS

Body Material	Plastic and Aluminium
Diffuser Material	Polycarbonate (Opal)
IP Rating	IP20
CRI	> 80
SDCM	< 7
Driver	Linear
Input Voltage	220-240Vac, 50/60Hz

Electrical Classification	Class II
Power Factor	≥ 0.55
Protection	Overload / Short Circuit
Projected Lifespan	> 15,000hrs @Ta25°C
Operating Ambient Temperature	Ta25°C

APPLICATIONS

Bedrooms
Lounge Room
Dining Area
Kitchen / Food Prep
Butler Pantry
Hallways
Entrance
Staircase
Ensuite
Bathrooms
Walk-in Wardrobes

DIMENSIONS

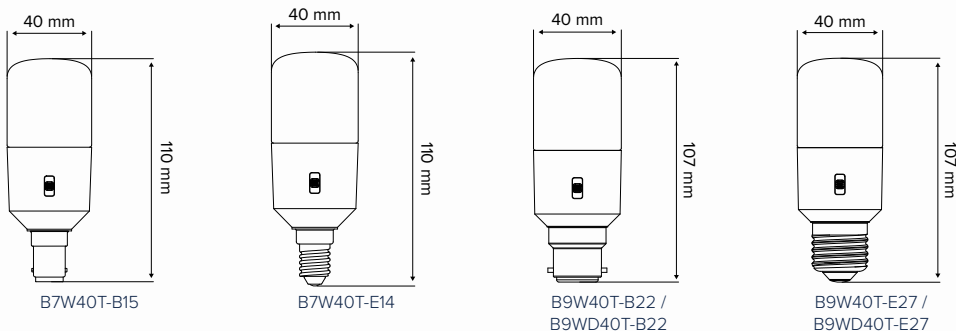

Find out more



GU10

Provides the choice of light hues from a single luminaire

Tritone colour selectable



Utilise existing enclosure to reduce energy consumption

LED retrofit design

Quick easy installation requiring no tools

Plug and Play

GU10

The perfect replacement.

Upgrade your space to energy-efficient LED lighting with our GU10 retrofit lamp! This all-in-one lamp seamlessly replaces your old halogen lamps, offering a choice of 3 colour temperatures and two wattages to suit any room. Enjoy significant energy savings and a brighter, cooler lighting experience without the hassle of replacing fixtures.



PRODUCT RANGE



Product Code	B4WTRI-GU10	B6WTRI-GU10
SAP Code	2002405	2002406
Power	4 W	6 W
Lumen Output	390 lm	570 lm
Efficacy	100 lm/W	95 lm/W
CCT	3000 / 4000 / 6500 K	3000 / 4000 / 6500 K
Connection Type	GU10 Pin	GU10 Pin
Dimensions	Ø50 x 60 mm	Ø50 x 60 mm
Weight	0.03 kg	0.03 kg
Beam Angle	50°	50°
Product Colour	White	White
Dimmable	Non-Dimmable	Non-Dimmable

COMMON SPECIFICATIONS

Body Material	Plastic and Aluminum	Electrical Classification	Class II
Diffuser Material	Polycarbonate (Clear)	Power Factor	> 0.5
IP Rating	IP20	Protection	Overload / Short Circuit
CRI	> 80	Projected Lifespan	> 15,000hrs @Ta25°C
SDCM	< 5	Operating Ambient Temperature	Ta 25°C
Driver	Linear		
Input Voltage	220-240V, 50/60Hz		

APPLICATIONS

Bedrooms
Lounge Room
Dining Area
Kitchen / Food Prep
Butler Pantry
Hallways
Entrance
Staircase
Ensuite
Bathrooms
Walk-in Wardrobes

DIMENSIONS

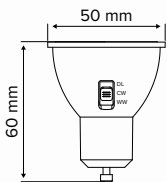

B4WTRI-GU10 / B6WTRI-GU10

Find out more



MR16



**Quick easy installation
requiring no tools**

Plug and Play

**Utilise existing
enclosure to reduce
energy consumption**

LED retrofit design

**Provides the choice of light
hues from a single luminaire**

Tritone colour selectable

MR16

The perfect replacement.

Upgrade your space to energy-efficient LED lighting with our MR16 Retrofit Lamp! This all-in-one lamp seamlessly replaces your old halogen lamps, offering a choice of 3 colour temperatures and two wattages to suit any room. Enjoy significant energy savings and a brighter, cooler lighting experience without the hassle of replacing fixtures.

TRITONE
Colour
Selectable

INSTALL
Easy
Installation

IP20
Ingress
Protection
Rating

1yr
Warranty

PRODUCT RANGE



Product Code	B4WTRI-MR16	B6WTRI-MR16
SAP Code	2002403	2002404
Power	4 W	6 W
Lumen Output	460 lm	640 lm
Efficacy	115 lm/W	106 lm/W
CCT	3000 / 4000 / 6500 K	3000 / 4000 / 6500 K
Connection Type	MR16 GU3.5 Pin	MR16 GU3.5 Pin
Dimensions	Ø50 x 56 mm	Ø50 x 56 mm
Weight	0.03 kg	0.03 kg
Beam Angle	50°	50°
Product Colour	White	White
Dimmable	Non-Dimmable	Non-Dimmable

COMMON SPECIFICATIONS

Body Material	Plastic and Aluminum	Electrical Classification	Class II
Diffuser Material	Polycarbonate (Clear)	Protection	Overload / Short Circuit
IP Rating	IP20	Projected Lifespan	> 15,000hrs @Ta25°C
CRI	> 80	Operating Ambient Temperature	Ta 25°C
SDCM	< 5		
Driver	Linear		
Input Voltage	12V DC		

APPLICATIONS

Bedrooms
Lounge Room
Dining Area
Kitchen / Food Prep
Butler Pantry
Hallways
Entrance
Staircase
Ensuite
Bathrooms
Walk-in Wardrobes

DIMENSIONS

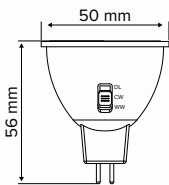

B4WTRI-MR16 / B6WTRI-MR16

Find out more

