

LIGHTING CONTROL AND AUTOMATION



DUO ^{G2}	258
SOLO	260
GENIE	262
SMART DIMMER MECHANISM	264
SMART SWITCH MECHANISMS	266
SMART REMOTE SWITCH MECHANISMS	268
MECHANISM BUTTON CAPS	270
PICTOGRAM BUTTON CAPS	271
HESPERUS™ MULTIVUE	274
HESPERUS™ PUSH	276
SMART POWERPOINTS	278
SMART SURFACE SOCKETS	282
SMART MODULES	284
CLOUD CONNECT GATEWAY	288
PLEXY GATEWAY	290
SMART HANDHELD REMOTE	292
SENTURA	294
ACCESSORIES	296
MOTION SENSOR RANGE	298



Saint Moritz, St Kilda VIC



Adelaide Marriott Hotel, SA

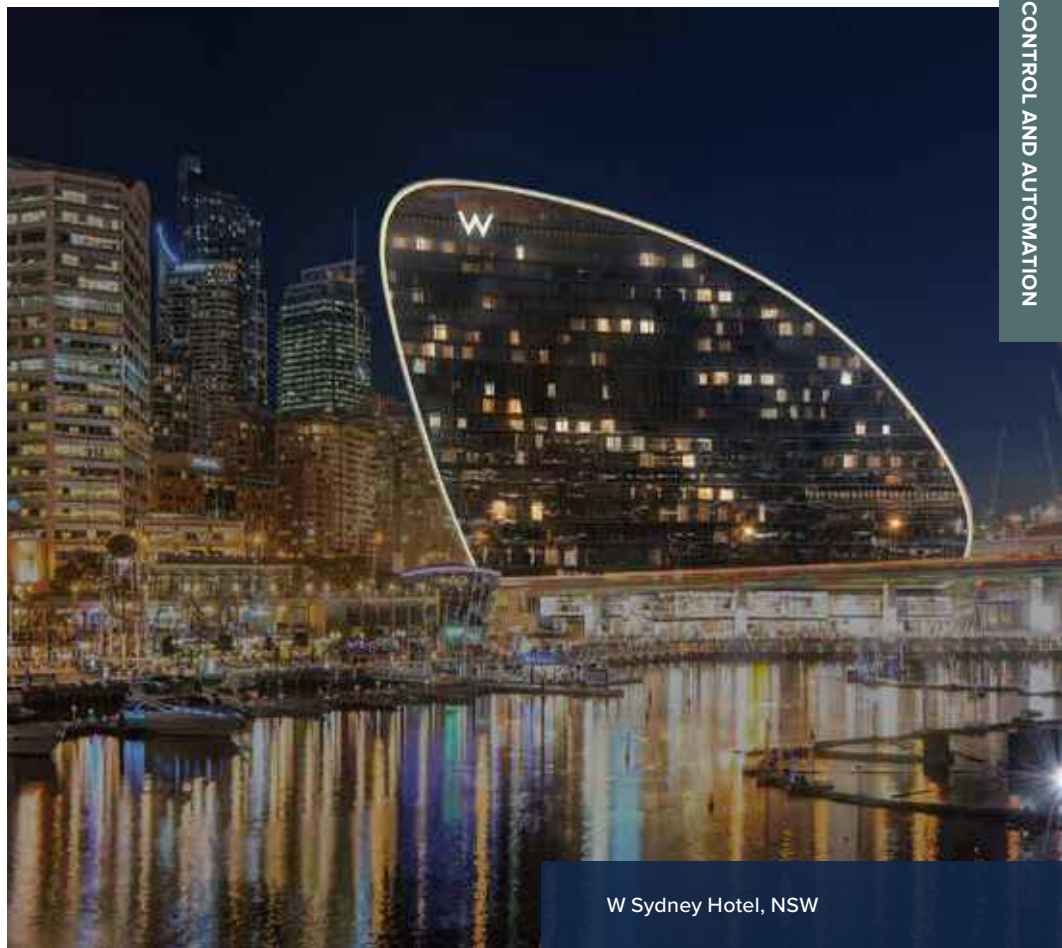

W Sydney Hotel, NSW

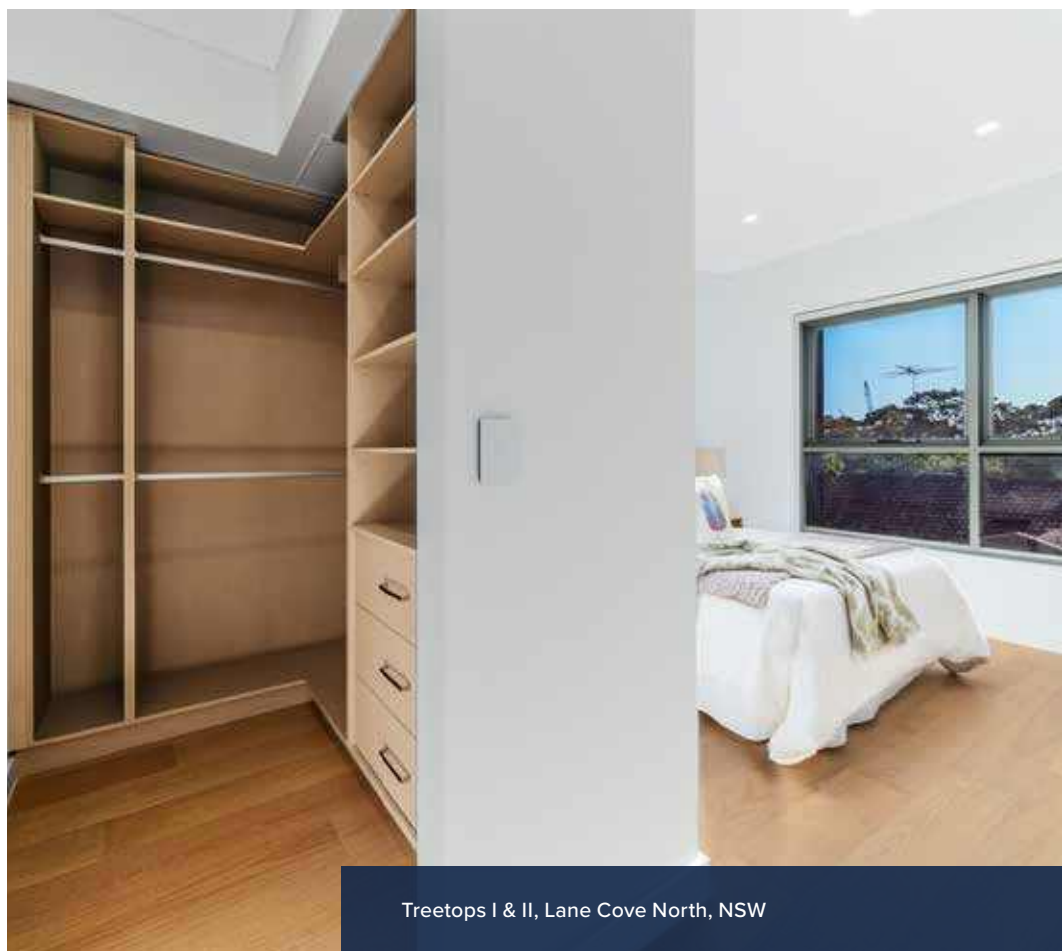

Treetops I & II, Lane Cove North, NSW

Combines a rotary dimmer with a push-on/off switch for simple control

2-in-1 control functionality

Provides low-light visibility for easier finding in the dark (optional)

Subtle blue backlight

Specifically designed for smooth dimming of Haneco LED luminaires

LED compatibility

Can be used in multi-switch configurations with additional switches

Multi-gang compatibility



Delivers smooth and flicker-free dimming performance for an enhanced user experience

Advanced dimming technology

Convenient load correction for confident compatibility

Load bypass capacitor included

DUO^{G2}

Need a dimmer + switch? Use the perfect DUO^{G2}.

The DUO G2 LED Dimmer Switch has been designed specifically to dim Haneco's dimmable luminaires so you can be sure it will work as required for complete ambience control. Load bypass capacitor included.



Phase Cut Dimming



Ingress Protection Rating



Multiple Control Methods



Easy Installation



3yr Warranty

PRODUCT RANGE



Product Code	DUO350WG2
SAP Code	2002378
Dimming Method	Phase-Cut Dimming (TE)
Dimming Range	2 % to 100 %
Dimensions	24 x 24 x 53 mm
Product Colour	White
Weight	25 g

QUICK FACTS

- Trailing edge dimmer suitable for compatible Haneco fittings
- Maximum load 350W (e.g. over twenty LED downlights)
- Compatible with standard wall plates and apertures
- Easy adjustment of minimum or maximum dimming
- Integrated switch and dimmer knob
- On/off switch can be disabled
- Easy to locate in the dark with subtle blue backlighting
- Simple 2 wire design for easy installation
- Smooth dimming to off over 30 mins
- Smooth dimming to maximum brightness over 30 mins
- Load bypass capacitor included

COMMON SPECIFICATIONS

Supply Voltage	220-240 V, 50 / 60 Hz	Overvoltage Protection	Yes
Maximum Load Wattage	350 W	Overtemperature Protection	Yes
Operating Ambient Temperature	0 to 50 °C	Noise Immunity	Yes
Thermal Derating	25 to 50 °C	Retain Dimmer Setting	Yes
Set/Reset Max. Brightness	Push Button (5 Clicks)	Mechanical Stop (set min/max brightness)	Yes
Max. Compatibility	Push Button (6 Clicks)	Overvoltage Protection	Yes
Optimised Dimming	Push Button (7 Clicks)	Overtemperature Protection	Yes
Reset to Factory Settings	Push Button (9 Clicks)	Connection Type	110mm Flying Leads
Overcurrent Protection	Yes	Housing	Polycarbonate (PC)
		Warranty	3 yrs

APPLICATIONS

Function Areas
 Bedrooms
 Offices
 Lounge Room
 Hotel Rooms
 Dining Area
 Boardroom / Meeting Rooms

DIMENSIONS

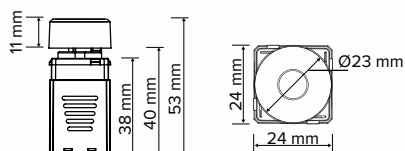

DUO350WG2

CONNECTION

ONE WAY CONNECTION
(ON/OFF ENABLED)

UNSWITCHED ACTIVE

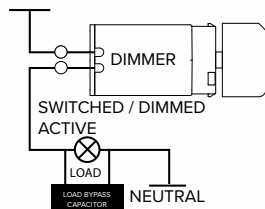

TWO WAY CONNECTION
(ON/OFF DISABLED)

ACTIVE

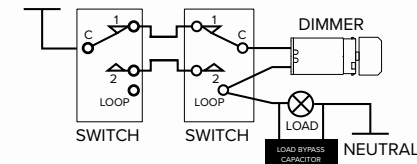

ACCESSORIES

Load Control Accessories



Load Bypass Capacitor 0.33uF/305Vac
 Capacitance Value
LCC25UF
 (included)



2 Wire Load Correction Device
LCDEV
 (SAP 2002542)

Rotary Dimmer Knobs



White Dimmer Knob
DUOG2-KNOB-WH
 (SAP 2002363)



Black Dimmer Knob
DUOG2-KNOB-BK
 (SAP 2002364)

DERATING LEVELS		
Multigang Derating	Max Load (at 25 °C)	Min Load (at 50 °C)
1	350 W	175 W
2	300 W	150 W
3	250 W	125 W
4	200 W	100 W

Find out more



Delivers precise control from low to high brightness

Smooth dimming

Specifically designed for smooth dimming of Haneco LED luminaires

LED compatibility



Convenient load correction for confident compatibility

Load bypass capacitor included

SOLO

Switch sorted? Dim it down with SOLO.

The SOLO LED Dimmer features advanced phase-cut dimming technology and an optimised dimming range for reliable, smooth and precise control of Haneco's dimmable luminaires. Load bypass capacitor included.



DIM

Phase Cut Dimming



IP20

Ingress Protection Rating



INSTALL

Easy Installation



3yr

Warranty

PRODUCT RANGE



Product Code	SOLO350W
SAP Code	2002358
Dimming Method	Phase-Cut Dimming (TE)
Dimming Range	2 % to 100 %
Dimensions	24 x 24 x 53 mm
Product Colour	White
Weight	25 g

QUICK FACTS

- Trailing edge dimmer suitable for compatible Haneco fittings
- Maximum load 350W (e.g. over twenty LED downlights)
- Compatible with standard wall plates and apertures
- Simple 2 wire design for easy installation
- Load bypass capacitor included

COMMON SPECIFICATIONS

Supply Voltage	220-240 V, 50/60 Hz	Overtemperature Protection	Yes
Maximum Load Wattage	350 W	Noise Immunity	Yes
Operating Ambient Temperature	0 to 40 °C	Retain Dimmer Setting	Yes
Thermal Derating	-20 to 70 °C	Mechanical Stop	No
Overcurrent Protection	Yes	Connection Type	110mm Flying Leads
Overvoltage Protection	Yes	Housing	Polycarbonate (PC)
		Warranty	3 yrs

APPLICATIONS

Function Areas
 Bedrooms
 Offices
 Lounge Room
 Hotel Rooms
 Dining Area
 Boardroom / Meeting Rooms

DIMENSIONS

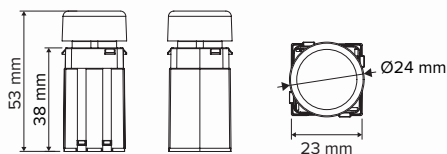

SOLO350W

CONNECTION

ONE WAY CONNECTION

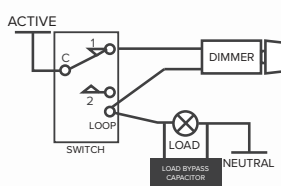

TWO WAY CONNECTION

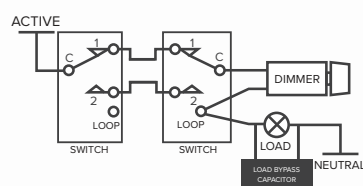

ACCESSORIES

Load Control Accessories



Load Bypass Capacitor 0.33uF/305Vac
 Capacitance Value
LCC25UF
 (included)



2 Wire Load Correction Device
LCDEV
 (SAP 2002542)

Rotary Dimmer Knobs



White Dimmer Knob
SOLO-KNOB-WH
 (SAP 2002360)



Black Dimmer Knob
SOLO-KNOB-BK
 (SAP 2002361)

DERATING LEVELS		
Multigang Derating	Max Load (at 25 °C)	Min Load (at 50 °C)
1	350 W	175 W
2	300 W	150 W
3	250 W	125 W
4	200 W	100 W

Find out more



Delivers precise control from low to high brightness

Smooth 1-10V dimming

Suits new or retrofit installs

Suits most Australian wall plates

Fits shallow wall cavities and most mounting accessories

Compact mechanism housing

Precise control

Set minimum dimming level



GENIE

Smooth dimming control.

1-10V rotary dimmer mechanism for the smooth dimming control of commercial and industrial lighting products. Specifically used for dimming luminaires that have a 1-10V analogue dimmable driver.



PRODUCT RANGE



Product Code	GN10VDIM-W
SAP Code	2001827
Dimming Method	1-10V dimming
Dimensions	23 x 23 x 48 mm
Product Colour	White
Weight	19 g

QUICK FACTS

- Smooth 1-10V dimming
- Suits most Australian wall plates
- Compact mechanism housing
- Set minimum dimming level

COMMON SPECIFICATIONS

Output	1-10V Signal	Retain Dimmer Setting	Yes
Maximum Input Current	40mA	Mechanical Stop	Yes
Operating Ambient Temperature	0°C - 50°C	Connection Type	Terminals
Suggested Maximum Number of Drivers Connected to Dimmer	30	Housing	Polycarbonate (PC)
		Warranty	3 yrs

APPLICATIONS

Manufacturing Facilities
Warehouses
Theatre Rooms
Showrooms

DIMENSIONS

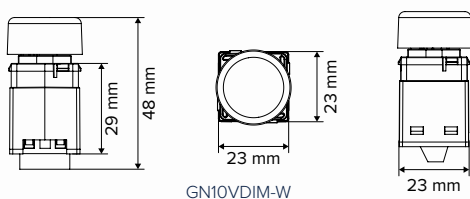

GN10VDIM-W

CONNECTION

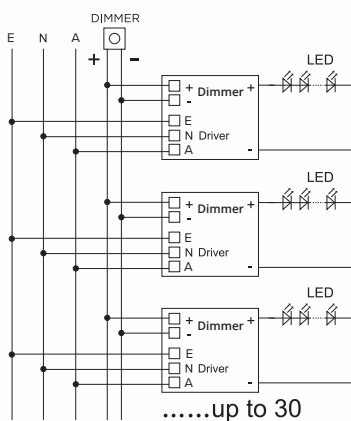

Find out more



Combines a push button dimmer with a push on/off switch for simple control

2-in-1 control functionality

Delivers precise control from low to high brightness

Smooth dimming

Fits up to 6 in a standard wall plate

Compact design



Simple wiring for quick installation

Easy wiring setup

 KASTA

DIMMER MECHANISM

Smart push button control.

The KASTA Smart Dimmer features a slim design, soft touch, push button control, and offers wireless control from any smart device. Enjoy simple setup and operation through the KASTA app.



BT

Bluetooth 5.0
Mesh Network
Connectivity



DIM

Phase Cut
Dimming



IP20

Ingress
Protection
Rating



INSTALL CONTROL

Easy
Installation



CONTROL

Multiple
Control
Methods



3yr

Warranty

PRODUCT RANGE



Product Code	KASTA-DM300BH-W
SAP Code	5000063
Wattage	300 W
Dimension	23 x 23 x 42 mm
Product Colour	White

QUICK FACTS

- Integrated switch
- Smooth dimming
- Subtle blue backlight
- Easy installation
- Capacity & flexibility
- Load bypass capacitor included

COMMON SPECIFICATIONS

Power Supply	220-240V a.c. 50Hz	Multi-gang Derating	2-270W, 3-240W, 4-200W, 5-150W, 6-100W @ 25°C
Operating Ambient Temperature	-20 to 40°C	Housing Material	Polycarbonate (PC)
IP Rating	IP20	Standards Complied	AS/NZS 60669.2.1, AS/NZS 60669.1, AS/NZS CISPR 15, AS/NZS 4268
Thermal Derating	25 to 40°C (300W-100W)	Dimming Range	2-100%
Physical Connection Type	Fly leads	Dimming Method	Phase-Cut Dimmable (Trailing Edge, 1-100%)
Wiring Connections	Active & Load		
LED Load Wattage	3W* - 300W**		
LED Indicators	Blue		

APPLICATIONS

Residential
Hospitality
Commercial

ACCESSORIES

KASTA Mechanism Button Caps



Button Caps
KMCAP-CS-TR
(SAP 5000084)



Button Caps
KMCAP-CT-W
(SAP 5000080)



Button Caps
KMCAP-CT-BK
(SAP 5000082)



Button Caps
KMCAP-CT-MBK
(SAP 5000466)



Button Caps
KMCAP-HL-W
(SAP 5000081)



Button Caps
KMCAP-HL-BK
(SAP 5000083)

Load Correction Accessories



Button Caps
KMCAP-LE-WH
(SAP 5000085)



Button Caps
KASTA-CAPS-B
(SAP 5000003)



Pictogram Button Caps
see page 271



2 Wire Load Correction Device
LCDEV
(SAP 2002542)

DIMENSIONS

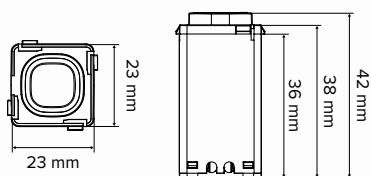

KASTA-DM300BH-W

CONNECTION

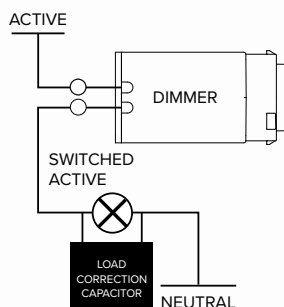

Find out more



Simple, modern
functionality

Push button on/off control

Fits up to 6 in a standard
wall plate

Compact design

Can be used in multi-
switch configurations with
additional remote switches

Multi-gang compatibility

Simple wiring for quick
installation

Easy wiring setup

Peace of mind

3 year warranty



 KASTA

SWITCH RELAY MECHANISMS

Smart switch solution.

KASTA Switch Relay Mechanisms provide push button on/off control of non-dimmable luminaires. Enjoy simple setup and operation through the KASTA app.



BT

Bluetooth 5.0
Mesh Network
Connectivity



IP20

Ingress
Protection
Rating



INSTALL

Easy
Installation



3yr

Warranty

PRODUCT RANGE



Product Code	KASTA-RM1440BH-W	KASTA-S350BH-W
SAP Code	5000194	5000002
Wattage	1440 W	350 W
Dimension	23 x 23 x 42 mm	22 x 40 x 43 mm
Product Colour	White	White
Thermal Derating	25 to 40°C (1440W-475W)	25 to 40°C (350W-190W)
Wiring Connections	Active, Load & Neutral	Active & Load
LED Load Wattage	15W - 1440W*, M.5	15W - 350W*
Multi-gang Derating	2-1300W, 3-1150W, 4-950W, 5-720W, 6-475W @ 25°C	2-260W, 3-190W @ 25°C

COMMON SPECIFICATIONS

Power Supply	220-240V a.c. 50Hz	Housing Material	Polycarbonate (PC)
Operating Ambient Temperature	-20 to 40°C	LED Indicators	Blue
IP Rating	IP20	Standards Complied	CoS SAA 183650, AS/NZS 60669.2.1, AS/NZS 60669.1, AS/NZS CISPR 15, AS/NZS 4268
Physical Connection Type	Fly leads		

APPLICATIONS

Residential
Hospitality
Commercial

ACCESSORIES

KASTA Mechanism Button Caps



Button Caps
KMCAP-CS-TR
(SAP 5000084)



Button Caps
KMCAP-CT-W
(SAP 5000080)



Button Caps
KMCAP-CT-BK
(SAP 5000082)



Button Caps
KMCAP-CT-MBK
(SAP 5000466)



Button Caps
KMCAP-HL-W
(SAP 5000081)



Button Caps
KMCAP-HL-BK
(SAP 5000083)



Button Caps
KMCAP-LE-WH
(SAP 5000085)



Button Caps
KASTA-CAPS-B
(SAP 5000003)



Pictogram Button Caps
see page 271

DIMENSIONS

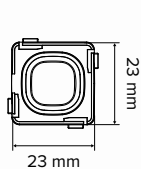

KASTA-RM1440BH-W

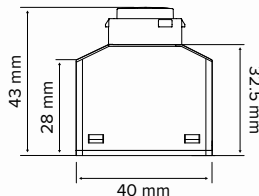
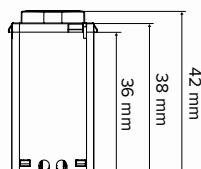

KASTA-S350BH-W



CONNECTION

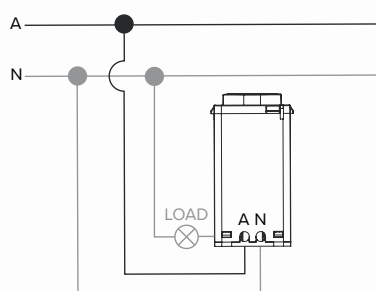

KASTA-RM1440BH-W

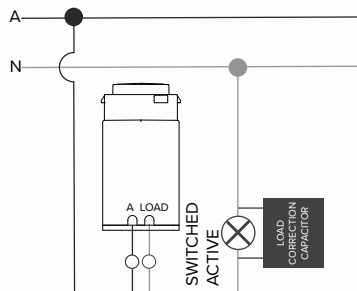

KASTA-S350BH-W

Find out more



Control individual lights, set scenes & receive feedback for optimized lighting

2-way communication

Fits limited spaces easily

Compact design

Simple installation and adjustability

Easily adjustable

Dim, adjust colour and more to create dynamic lighting environments

Multi-function control

Peace of mind

3 year warranty



 KASTA

REMOTE SWITCH MECHANISMS

Smart wireless control.

KASTA 1-Button Remote Switch Mechanisms, incl. 2 White button caps (2 styles). Control individual lights and scenes without the need for cabling between the mechanism and the device.



BT

Bluetooth 5.0
Mesh Network
Connectivity



IP20

Ingress
Protection
Rating



INSTALL

Easy
Installation



3yr

Warranty

PRODUCT RANGE



Product Code	KASTA-1BMBH-W	KASTA-RB02-W
SAP Code	5000018	5000006
Dimension	23 x 23 x 42 mm	45 x 24.5 x 9.5 mm
Product Colour	White	White
Power Supply	220-240V a.c. 50Hz	CR2032 Lithium Battery x2 + an additional 2 x CR2032 are included
Battery Life	N/A	Up to 2 years (approx. 50,000 presses)

QUICK FACTS

- Wireless control
- Easy installation

COMMON SPECIFICATIONS

Operating Ambient Temperature	-20 to 40°C	LED Indicators	Blue
IP Rating	IP20	Standards Complied	AS/NZS 60950.1, AS/NZS CISPR 15, AS/NZS 4268
Housing Material	Polycarbonate (PC)		

APPLICATIONS

Residential
Hotels
Commercial

ACCESSORIES

KASTA Mechanism Button Caps



Button Caps
KMCAP-CS-TR
(SAP 5000084)



Button Caps
KMCAP-CT-W
(SAP 5000080)



Button Caps
KMCAP-CT-BK
(SAP 5000082)



Button Caps
KMCAP-CT-MBK
(SAP 5000466)



Button Caps
KMCAP-HL-W
(SAP 5000081)



Button Caps
KMCAP-HL-BK
(SAP 5000083)



Button Caps
KMCAP-LE-WH
(SAP 5000085)



Button Caps
KASTA-CAPS-B
(SAP 5000003)



Pictogram Button Caps
see page 271

DIMENSIONS

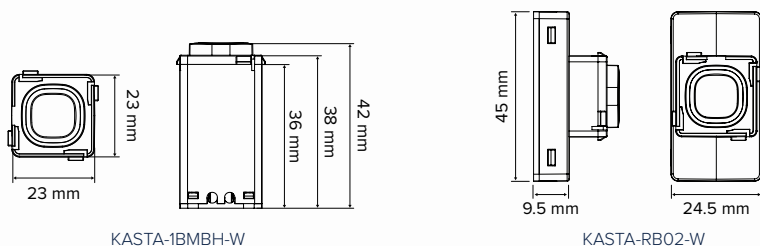

CONNECTION

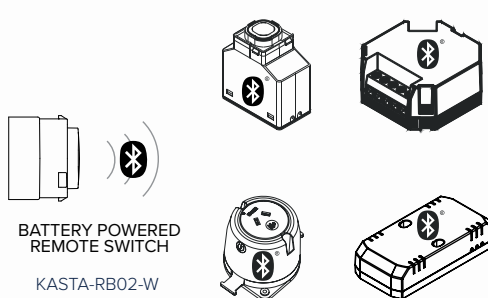
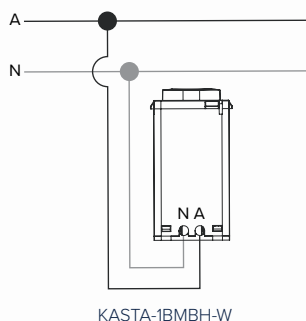

Find out more



MECHANISM BUTTON CAPS

Flexible options for maximum compatibility.

KASTA Mechanism Button Caps allow KASTA Mechanisms to interface to a multitude of plate series available in Australia.



Features

- Adaptable mounting possibilities
- Choice of colour finishes
- New and retrofit

Benefits

- Choose which mounting option best suits the application
- Blend fitting into the existing environment seamlessly
- Suitable for new install, retrofit and upgrade applications



Product Code	KMCAP-CS-TR	KMCAP-CT-W	KMCAP-CT-BK	KMCAP-CT-MBK	KMCAP-HL-W
SAP Code	5000084	5000080	5000082	5000466	5000081
Dimension	12 x 15 x 8 mm	16 x 16 x 8 mm	16 x 16 x 8 mm	16 x 16 x 8 mm	16 x 16 x 8 mm
Product Colour	Transparent	White	Black	Matte Black	White
Suit	Clipsal Saturn/ Clipsal Saturn Zen	Trader	Trader	Trader	HPM/Legrand Linea, Excel, Standard



Product Code	KMCAP-HL-BK	KMCAP-LE-WH	KASTA-CAPS-B
SAP Code	5000083	5000085	5000003
Dimension	16 x 16 x 8 mm	16 x 16 x 8 mm	16 x 16 x 8 mm
Product Colour	Black	Black	Black
Suit	HPM/Legrand Linea, Excel, Standard	Legrand Excel Life	Trader HPM/Legrand Linea, Excel, Standard

The Clipsal, Saturn and Saturn Zen brands are trademarks of Schneider Electric (Australia) Pty Ltd. Legrand, HPM, Linea, Excel and Excel Life brands are trademarks of Legrand Australia Pty Ltd. Trader is a trademark of GSM Electrical (Australia) Pty Ltd.

Find out more



PICTOGRAM MECHANISM BUTTON CAPS

Customised switch labelling.

A range of pictogram button caps that clip onto KASTA push button mechanisms for easy identification and a customised experience.



Features

- Adaptable mounting possibilities
- Aesthetic appeal
- Durable UV stabilised polycarbonate
- Extensive model range

Benefits

- Choose which mounting option best suits the application
- Complement architectural and design concepts
- Long lasting quality to avoid discoloration
- Covers a diverse range of applications

SUITABLE FOR EDGY + HESPERUS SERIES SWITCH GRID PLATES + COVERS



Product Code	KMCAP-CTP01-W	KMCAP-CTP02-W	KMCAP-CTP03-W	KMCAP-CTP04-W	KMCAP-CTP05-W
SAP Code	5000138	5000139	5000140	5000141	5000142
Dimension	23 x 23 x 6 mm	23 x 23 x 6 mm	23 x 23 x 6 mm	23 x 23 x 6 mm	23 x 23 x 6 mm
Product Colour	White	White	White	White	White



Product Code	KMCAP-CTP06-W	KMCAP-CTP07-W	KMCAP-CTP08-W	KMCAP-CTP09-W	KMCAP-CTP10-W
SAP Code	5000143	5000144	5000145	5000146	5000147
Dimension	23 x 23 x 6 mm	23 x 23 x 6 mm	23 x 23 x 6 mm	23 x 23 x 6 mm	23 x 23 x 6 mm
Product Colour	White	White	White	White	White



Product Code	KMCAP-CTP11-W	KMCAP-CTP12-W	KMCAP-CTP13-W	KMCAP-CTP14-W	KMCAP-CTP15-W
SAP Code	5000148	5000149	5000150	5000151	5000152
Dimension	23 x 23 x 6 mm	23 x 23 x 6 mm	23 x 23 x 6 mm	23 x 23 x 6 mm	23 x 23 x 6 mm
Product Colour	White	White	White	White	White



Product Code	KMCAP-CTP16-W	KMCAP-CTP17-W	KMCAP-CTP18-W	KMCAP-CTP19-W	KMCAP-CTP20-W
SAP Code	5000153	5000154	5000155	5000156	5000157
Dimension	23 x 23 x 6 mm	23 x 23 x 6 mm	23 x 23 x 6 mm	23 x 23 x 6 mm	23 x 23 x 6 mm
Product Colour	White	White	White	White	White

Find out more





Product Code	KMCAP-CTP21-W	KMCAP-CTP22-W	KMCAP-CTP23-W	KMCAP-CTP24-W	KMCAP-CTP25-W
SAP Code	5000158	5000159	5000160	5000161	5000162
Dimension	23 x 23 x 6 mm	23 x 23 x 6 mm	23 x 23 x 6 mm	23 x 23 x 6 mm	23 x 23 x 6 mm
Product Colour	White	White	White	White	White



Product Code	KMCAP-CTP26-W	KMCAP-CTP27-W	KMCAP-CTP28-W	KMCAP-CTP29-W	KMCAP-CTP30-W
SAP Code	5000163	5000164	5000165	5000166	5000167
Dimension	23 x 23 x 6 mm	23 x 23 x 6 mm	23 x 23 x 6 mm	23 x 23 x 6 mm	23 x 23 x 6 mm
Product Colour	White	White	White	White	White



Product Code	KMCAP-CTP31-W	KMCAP-CTP32-W
SAP Code	5000168	5000169
Dimension	23 x 23 x 6 mm	23 x 23 x 6 mm
Product Colour	White	White

SUITABLE FOR HESPERUS SERIES PUSH REMOTE SWITCHES ONLY



Product Code	KMCAP-HP01-W	KMCAP-HP02-W	KMCAP-HP03-W	KMCAP-HP04-W	KMCAP-HP05-W
SAP Code	5000381	5000382	5000383	5000384	5000385
Dimension	16 x 16 x 9 mm	16 x 16 x 9 mm	16 x 16 x 9 mm	16 x 16 x 9 mm	16 x 16 x 9 mm
Product Colour	White	White	White	White	White



Product Code	KMCAP-HP06-W	KMCAP-HP07-W	KMCAP-HP08-W	KMCAP-HP09-W	KMCAP-HP10-W
SAP Code	5000386	5000387	5000388	5000389	5000390
Dimension	16 x 16 x 9 mm	16 x 16 x 9 mm	16 x 16 x 9 mm	16 x 16 x 9 mm	16 x 16 x 9 mm
Product Colour	White	White	White	White	White



Product Code	KMCAP-HP11-W	KMCAP-HP12-W	KMCAP-HP13-W	KMCAP-HP14-W	KMCAP-HP15-W
SAP Code	5000391	5000392	5000393	5000394	5000395
Dimension	16 x 16 x 9 mm	16 x 16 x 9 mm	16 x 16 x 9 mm	16 x 16 x 9 mm	16 x 16 x 9 mm
Product Colour	White	White	White	White	White



Product Code	KMCAP-HP16-W	KMCAP-HP17-W	KMCAP-HP18-W	KMCAP-HP19-W	KMCAP-HP20-W
SAP Code	5000396	5000397	5000398	5000399	5000400
Dimension	16 x 16 x 9 mm	16 x 16 x 9 mm	16 x 16 x 9 mm	16 x 16 x 9 mm	16 x 16 x 9 mm
Product Colour	White	White	White	White	White



Product Code	KMCAP-HP21-W	KMCAP-HP22-W	KMCAP-HP23-W	KMCAP-HP24-W	KMCAP-HP25-W
SAP Code	5000401	5000402	5000403	5000404	5000405
Dimension	16 x 16 x 9 mm	16 x 16 x 9 mm	16 x 16 x 9 mm	16 x 16 x 9 mm	16 x 16 x 9 mm
Product Colour	White	White	White	White	White



Product Code	KMCAP-HP26-W	KMCAP-HP27-W	KMCAP-HP28-W	KMCAP-HP29-W	KMCAP-HP30-W
SAP Code	5000406	5000407	5000408	5000409	5000410
Dimension	16 x 16 x 9 mm	16 x 16 x 9 mm	16 x 16 x 9 mm	16 x 16 x 9 mm	16 x 16 x 9 mm
Product Colour	White	White	White	White	White



Product Code	KMCAP-HP31-W	KMCAP-HP32-W	KMCAP-HP33-W
SAP Code	5000411	5000412	5000430
Dimension	16 x 16 x 9 mm	16 x 16 x 9 mm	16 x 16 x 9 mm
Product Colour	White	White	White

Find out more



Simple setup and operation

iOS and Android app
commissioning and control

Avoids discolouring

Durable UV stabilised
polycarbonate

Energy saving

Proximity sensor for
screen display

**Reliable and robust
wireless connectivity**

KASTA Bluetooth® mesh
network connectivity

**Flexible, customised
control**

Up to 20 reprogrammable
buttons



HESPERUS™ MULTIVUE

Unparalleled flexibility and control.

KASTA Hesperus™ Multivue is a 5-button remote switch interface with an LCD display for multiple page view. With the capability to control up to twenty KASTA devices, groups or scenes, Hesperus™ Multivue is most flexible wall switch control solution.



BT

Bluetooth 5.0
Mesh Network
Connectivity



IP20

Ingress
Protection
Rating



INSTALL

Easy
Installation



CONTROL

Multiple
Control
Methods



3yr

Warranty

PRODUCT RANGE



Product Code	H5MSMB-WH	H5MSMB-BK
SAP Code	5000192	5000193
Dimension	121 x 80 x 42 mm	121 x 80 x 42 mm
Product Colour	White	Black

QUICK FACTS

- 5-button control with multiple LCD screen pages allows users to dynamically manage and monitor groups, scenes and individual devices (up to 20 devices/scenes or rooms)
- Clear digital icons for easy identification of device to be controlled
- Proximity sensor activates the device for use
- Ambient temperature indicator (in-built sensor)
- Language options: English / Mandarin (simplified)

COMMON SPECIFICATIONS

Power Supply	220-240V a.c. 50Hz	Mounting Screw Type	Combination Flat / Philips Head Screws
Operating Ambient Temperature	-20 to 40°C	Frame Colour (Finish)	Black (Matte)
Wi-Fi Connectivity	Wi-Fi 802.11 g/b/n, 2.4Ghz	Plate Colour (Finish)	White / Black (Transparent / Gloss)
IP Rating	IP20	Housing Material	Acrylic / Polycarbonate (PC)
Plate Depth	13 mm	LED Indicators	Blue, White, Green, OFF (selectable through the KASTA app)
Terminal Size	16 mm ² (accommodates 4 x 2.5 mm ² cables)	Standards Complied	AS/NZS 62368.1, AS/NZS 4268, AS/NZS CISPR 32
Terminal Screw Type	Flat Terminal Screw		
Mounting Points	84mm / 100mm and Corners		

APPLICATIONS

Residential
Hotels
Commercial

DIMENSIONS

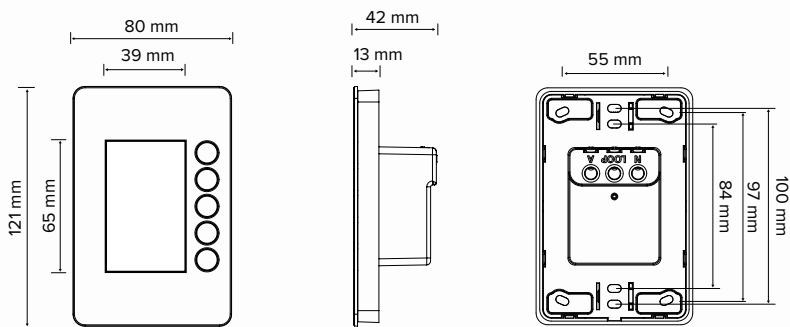

H5MSMB-WH / H5MSMB-BK

CONNECTION

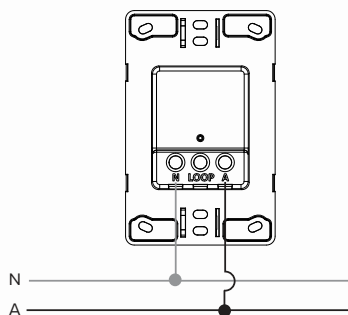

Find out more



Simple setup and operation

iOS and Android app
commissioning and control

Avoids discolouring

Durable UV stabilised
polycarbonate

Energy saving

Proximity sensor for
button LED indicators

**Reliable and robust
wireless connectivity**

KASTA Bluetooth® mesh
network connectivity

Flexible installation

Available in 1-6 button
configurations

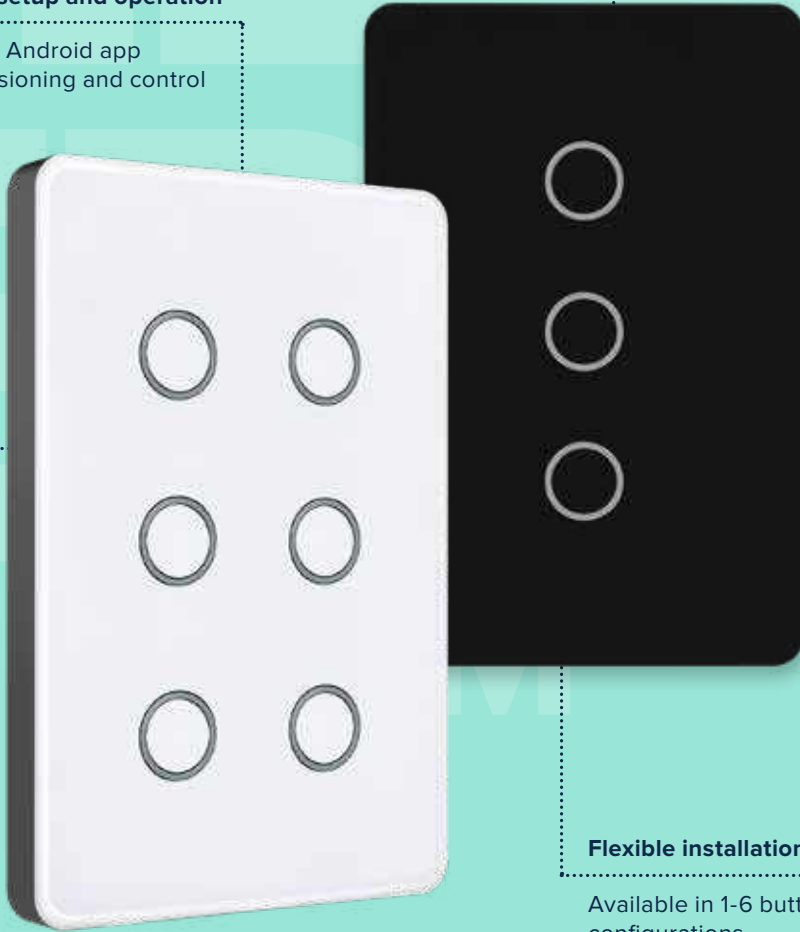

HESPERUS™ PUSH

Multifunctional, flexible.

KASTA Hesperus Push Remote Switches are available in 1-6 button configurations and feature soft push button control of KASTA devices, groups or scenes.



BT

Bluetooth 5.0
Mesh Network
Connectivity



IP20

Ingress
Protection
Rating



INSTALL

Easy
Installation



CONTROL

Multiple
Control
Methods



3yr

Warranty

PRODUCT RANGE

				
Product Code	H1RSMB-WH	H1RSMB-BK	H2RSMB-WH	H2RSMB-BK
SAP Code	5000226	5000227	5000228	5000229
Product Colour	White (Gloss)	Black (Gloss)	White (Gloss)	Black (Gloss)
				
Product Code	H3RSMB-WH	H3RSMB-BK	H4RSMB-WH	H4RSMB-BK
SAP Code	5000230	5000231	5000232	5000233
Product Colour	White (Gloss)	Black (Gloss)	White (Gloss)	Black (Gloss)
				
Product Code	H5RSMB-WH	H5RSMB-BK	H6RSMB-WH	H6RSMB-BK
SAP Code	5000234	5000235	5000236	5000237
Product Colour	White (Gloss)	Black (Gloss)	White (Gloss)	Black (Gloss)

COMMON SPECIFICATIONS

Power Supply	220-240V a.c. 50Hz	Dimension	121 x 80 x 42 mm
Operating Ambient Temperature	-20 to 40°C	Feedback	Audio (selectable through the KASTA app)
IP Rating	IP20	Frame Colour (Finish)	Black (Matte)
Plate Depth	11 mm	Plate Colour (Finish)	White / Black (Transparent / Gloss)
Terminal Size	16mm ² (accommodates 4x2.5mm ² cables)	Housing Material	Acrylic / Polycarbonate (PC)
Terminal Screw Type	Flat Terminal Screw	LED Indicators	Blue, White, Green (selectable through the KASTA app)
Mounting Points	84 mm / 100 mm and Corners	Standards Complied	AS/NZS 62368.1, AS/NZS 4268, AS/NZS CISPR 32
Mounting Screw Type	Combination Flat / Philips Head Screws		
Weight	0.11 kg		

APPLICATIONS

Bathrooms
Bedrooms
Boardroom / Meeting Rooms
Cocktail Lounges
Dining Area
Entrances
Function Areas
Games Rooms
Hallways
Hotel Common Areas
Hotel Rooms
Indoor Recreation
Kitchen / Food Prep
Lounge Room
Restaurants / Cafes
Retail Spaces
Showrooms
Staircase
Theatre Rooms
Walk-in Wardrobes

DIMENSIONS

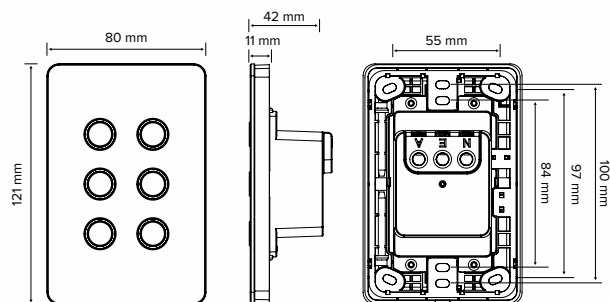

H6RSMB-WH / H6RSMB-BK

CONNECTION

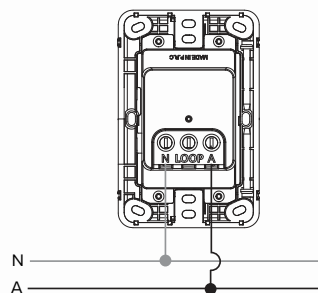

ACCESSORIES

Button Caps



Pictogram Button Caps
see page 271

Find out more



Enhanced energy savings and customised power management

Individual socket control

Enhanced safety feature

Child lock

Blend fitting into the existing environment seamlessly

Choice of colour finishes



Take control of your energy usage

Energy monitoring

Complement architectural and design concepts

Aesthetic appeal

 KASTA

SMART POWERPOINTS

Smart, energy efficient power.

KASTA Smart Powerpoints feature a range of contemporary designs with a choice of finishes that operate harmoniously in today's modern environments, décor and lifestyles. Each socket outlet can be individually controlled and monitored for energy consumption.



BT

Bluetooth 5.0
Mesh Network
Connectivity



IP20

Ingress
Protection
Rating



INSTALL

Easy
Installation



RANGE

Extensive
Product
Range



3yr

Warranty

PRODUCT RANGE - EDGY SERIES



Product Code	KE2PPHB-WH	KE2PPHB-BK
SAP Code	5000175	5000176
Dimension	120 x 80 x 42 mm	120 x 80 x 42 mm
Fascia Colour	White (Gloss)	Black (Matte)
Plate Depth	7.8 mm	7.8 mm

PRODUCT RANGE - HESPERUS SERIES



Product Code	H2PPHB-WH	H2PPHB-BK	H2PPHB-GY	H2PPHB-BU
SAP Code	5000040	4500094	4500096	4500097
Dimension	121 x 80 x 44 mm	121 x 80 x 44 mm	121 x 80 x 44 mm	121 x 80 x 44 mm
Product Colour	White (Gloss)	Black (Gloss)	Grey (Gloss)	Blue (Gloss)
Weight	0.16 kg	0.16 kg	0.16 kg	0.16 kg
Plate Depth	10 mm	10 mm	10 mm	10 mm



Product Code	H2PPHB-RD	H2PPHB-AL
SAP Code	4500099	4500103
Dimension	121 x 80 x 44 mm	121 x 80 x 44 mm
Product Colour	Red (Gloss)	Almond (Gloss)
Weight	0.16 kg	0.16 kg
Plate Depth	10 mm	10 mm

COMMON SPECIFICATIONS

Power Supply	220-240V a.c. 50Hz	Terminal Screw Type	Combination Flat/ Phillips head
Operating Ambient Temperature	-20 to 40°C	Current Rating	10A
IP Rating	IP20	Mounting Screw Type	Combination Flat/Phillips head
Energy Monitor	0.01A to 10A	Housing Material	Acrylic / Polycarbonate (PC)
Terminal Size	16mm ² (accommodates 4x2.5 mm ² cables)	LED Indicators	Blue (ON) / Green (Child Lock)
Mounting Points	84 mm / 100 mm and Corners	Standards Complied	CoS SAA 183650, AS/NZS 60669.2.1, AS/NZS 60669.1, AS/NZS CISPR 15, AS/NZS 4268

APPLICATIONS

Bedrooms
Boardroom / Meeting Rooms
Cocktail Lounges
Dining Area
Ensuite
Entrances
Function Areas
Games Rooms
Hallways
Hotel Common Areas
Hotel Rooms
Laundry
Kitchen / Food Prep
Lounge Room
Retail Spaces
Restaurants / Cafes
Showrooms
Theatre Rooms

Find out more



DIMENSIONS

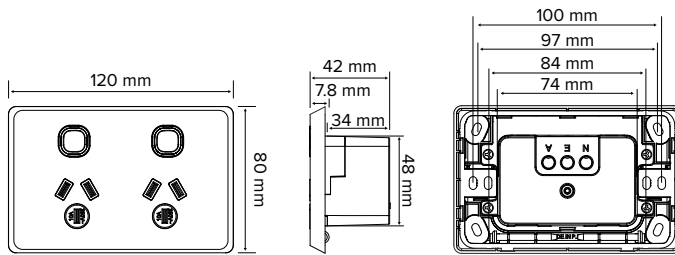

KE2PPHB-WH / KE2PPHB-BK

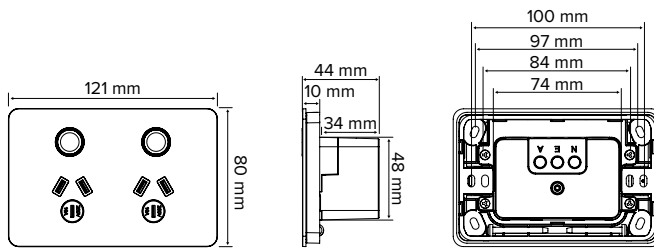

H2PPHB-WH / H2PPHB-BK / H2PPHB-GY / H2PPHB-BU /
H2PPHB-RD / H2PPHB-AL

CONNECTION

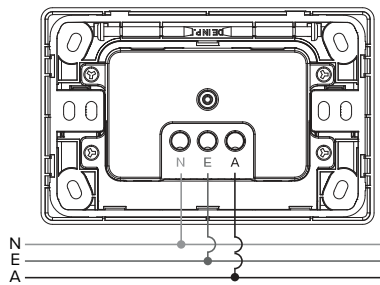

KE2PPHB-WH / KE2PPHB-BK

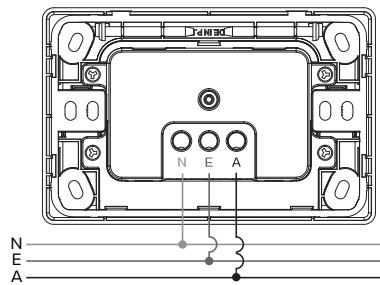

H2PPHB-WH / H2PPHB-BK /
H2PPHB-GY / H2PPHB-BU /
H2PPHB-RD / H2PPHB-AL



High visibility and easy identification in roof cavities

Striking product colour

Simple setup and operation

iOS and Android app commissioning and control

Innovative and industry leading smart control

Australian Product Patents



Convenient and simplified installation

Can connect up to multiple circuits within rated power

Reliable and robust wireless connectivity

KASTA Bluetooth® mesh network connectivity

 KASTA

SMART SURFACE SOCKETS

Industry leading Australian patented products.

Smart dimmer and relay socket plug bases that can be ceiling or surface mounted. Reliable Bluetooth® mesh network connectivity to all KASTA devices to support core KASTA smart functionality - control devices, groups, scenes, timers and scheduling.



BT

Bluetooth 5.0
Mesh Network
Connectivity



IP20

Ingress
Protection
Rating



INSTALL

Easy
Installation



3yr

Warranty

PRODUCT RANGE



Product Code	KBSKTD350	KBSKTR2400
SAP Code	5000039	5000176
Hole Cutout Size	Ø90 mm	Ø90 mm
Dimension	95 x 65 x 66.5 mm	95 x 65 x 66.5 mm
Product Colour	Yellow	Yellow
Thermal Derating	40 to 60°C (350W-250W)	40 to 60°C (2400W-1200W)
LED Load Wattage	350W, 1.4A*	2400W, 10A*, M.40
Dimming Method	Phase Cut Trailing Edge	N/A
Dimming Range	2-100%	N/A

QUICK FACTS

- Suits 3 pin plug
- Reliable Bluetooth® mesh network connectivity to all KASTA devices
- Can connect up to multiple circuits (within rated power rating)
- LED status indicator
- Reset button
- IPA stud provision for circuit identification
- Supports core KASTA functionality - control devices, groups, scenes, timers and scheduling
- Striking colour for easy identification in roof space
- Transparent nail plate for easy inspection of connections
- Multiple fixing points including external tabs for cable ties, clouts and screws
- Combination Flat & Philips terminal head screws
- Terminals to accept up to 4 x 2.5mm² cables
- iOS and Android app setup and control
- 3 year warranty

COMMON SPECIFICATIONS

Power Supply	220-240V a.c. 50Hz	Housing Material	Polycarbonate (PC)
Operating Ambient Temperature	-20 to 40°C		AS/NZS 3112, AS/NZS 3100,
IP Rating	IP20	Standards Complied	AS/NZS 60669.2.1, AS/NZS 60669.1, AS/NZS CISPR 15
Terminal Size	16mm ² (accommodates 4x2.5 mm ² cables)		
Terminal Screw Type	Combination Flat/Philips head		

APPLICATIONS

Residential
Commercial
Hospitality

DIMENSIONS

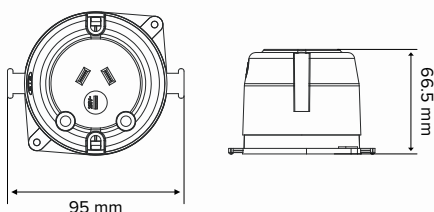

KBSKTD350 / KBSKTR2400

CONNECTION

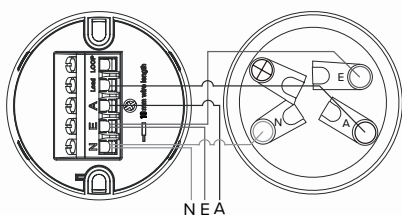

KBSKTD350 / KBSKTR2400

Find out more



SMART MODULES



Bluetooth 5.0
Mesh Network
Connectivity



Extensive
Product
Range



3yr
Warranty

Smart modules for the control of third party equipment.

KASTA offers a range of smart modules that can be connected to third party equipment for wireless control of air movement devices, window furnishing, doors and gates, irrigation and much more. Suitable for use in residential and commercial projects, offering wireless control benefits across a variety of applications.

Features

- KASTA Bluetooth® mesh network connectivity
- iOS and Android app commissioning and control
- Over-current / over-voltage protection
- Multiple installation options

Benefits

- Reliable and robust wireless connectivity
- Simple setup and operation
- Increased safety
- Quick and easy installation, suitable for retrofitting

Switch Relay Module

Smart switch relay module that connects to a momentary push button mechanism.



PRODUCT CODE	SAP CODE
KASTA-S2400IBH	5000005

SPECIFICATIONS	
Dimensions:	45 x 45 x 22mm
Power Supply:	220-240V a.c. 50Hz
IP Rating:	IP20
Operating Ambient Temperature:	-20 to 40°C
Thermal Derating:	25 to 40°C (2400W-1200W)
Multi-gang Derating:	2-1800W, 3-1320W @ 25°C
Physical Connection:	Terminals
Wiring Connections:	Active, Neutral, Load & Momentary Mechanism
Momentary Input (T1/T2):	Local signal input only (not 240V a.c.). Maximum wiring length between T1/T2 and momentary mechanism is 30m.
LED Load Wattage:	2W - 2400W
Housing Material:	Polycarbonate
Standards Complied:	CoS SAA 183649, AS/NZS 60669.2.1, AS/NZS 60669.1, AS/NZS CISPR 15, AS/NZS 4268

Dimmer Module

Smart dimmer module (phase cut trailing edge) that connects to a momentary push button mechanism.



PRODUCT CODE	SAP CODE
KASTA-D300IBH	5000004

SPECIFICATIONS	
Dimensions:	45 x 45 x 22mm
Power Supply:	220-240V a.c. 50Hz
IP Rating:	IP20
Operating Ambient Temperature:	-20 to 40°C
Thermal Derating:	25 to 40°C (300W-165W)
Multi-gang Derating:	2-225W, 3-165W @ 25°C
Physical Connection:	Terminals
Wiring Connections:	Active, Neutral, Load & Momentary Mechanism
Momentary Input (T1/T2):	Local signal input only (not 240V a.c.). Maximum wiring length between T1/T2 and momentary mechanism is 30m.
LED Load Wattage:	2W - 300W
Dimming Range:	2-100%
Housing Material:	Polycarbonate
Standards Complied:	CoS SAA 183649, AS/NZS 60669.2.1, AS/NZS 60669.1, AS/NZS CISPR 15, AS/NZS 4268

Dry Contact Output Module

Smart dry contact output module that connects to a momentary push button mechanism.

PRODUCT CODE

KASTA-S10IBH

SAP CODE

5000016

SPECIFICATIONS

Dimensions:	52 x 47 x 22.5mm
Power Supply:	220-240V a.c. 50Hz
IP Rating:	IP20
Operating Ambient Temperature:	-20 to 50°C
Physical Connection:	Terminals
Wiring Connections:	Active, Neutral, Load & Switch Mechanisms
Load Output Maximum:	2400W (10A)
Load Compatibility:	0 to 240V a.c. / 0 to 30V d.c.
Housing Material:	Polycarbonate
Standards Complied:	AS/NZS 60669.2.1, AS/NZS 60669.1, AS/NZS 60950.1, AS/NZS CISPR 15, AS/NZS 4268

Remote Switch 5-Input Module

Smart remote switch input module for the wireless control of KASTA devices from a wall switch with up to five individual mechanisms or a traditional 240V a.c. motion sensor.

PRODUCT CODE

KASTA-5RSIBH

SAP CODE

5000036

SPECIFICATIONS

Dimensions:	52 x 47 x 22.5mm
Power Supply:	220-240V a.c. 50Hz
IP Rating:	IP20
Operating Ambient Temperature:	-20 to 50°C
Physical Connection:	Terminals
Wiring Connections:	Active, Neutral, Momentary Mechanism or Sensor Load Output
Input Voltage:	240V a.c.
Housing Material:	Polycarbonate
Standards Complied:	AS/NZS 60950.1, AS/NZS CISPR 15, AS/NZS 4268

AC Ceiling Fan Controller

Smart AC ceiling fan controller providing capacitor switched 3-speed control of a fan plus ON/OFF lighting control.

PRODUCT CODE

KASTA-FC150A

SAP CODE

5000017

SPECIFICATIONS

Dimensions:	104 x 50 x 25 mm
Power Supply:	220-240V a.c. 50Hz
IP Rating:	IP20
Operating Ambient Temperature:	-20 to 40°C
Physical Connection:	Fly Leads
Wiring Connections:	Active, Neutral, Fan Motor, Fan Light, Momentary Mechanisms
Load Output Maximum:	Fan: 150W (0.6A), Light: 300W (1.2A)
Load Compatibility:	3-speed capacitor switched 240V a.c. ceiling sweep fan motor*, with or without inbuilt light
Housing Material:	Polycarbonate
Standards Complied:	AS/NZS 60669.2.1, AS/NZS 60669.1, AS/NZS CISPR 14.1, AS/NZS CISPR 15, AS/NZS 4268

Find out more



Curtain Control Module

Smart curtain control module that controls AC powered motors (4-wire switched motor) or DC powered motors (Class I or II) and connects to a momentary push button mechanism.



PRODUCT CODE	SAP CODE
KASTA-C300IBH	5000014

SPECIFICATIONS	
Dimensions:	52 x 47 x 22.5mm
Power Supply:	220-240V a.c. 50Hz
IP Rating:	IP20
Operating Ambient Temperature:	-20 to 40°C
Physical Connection:	Terminals
Wiring Connections:	Active, Neutral, Motor (Open/Close), Momentary Mechanisms
Load Output (Inductive) Maximum:	300W (1.2A)
Load Compatibility:	AC Motor: Standard bidirectional 4-wire 240VAC single phase motor with internal limit switches (2 Active, 1 Neutral, 1 Earth) DC Motor: Class I or Class II equipment only, up to 24VDC (max.) with internal limit switches
Momentary Input (S1/S2):	Local signal input only (not 240V a.c.) Max. wiring length between S1/S2 and momentary mechanism is 10m
Housing Material:	Polycarbonate
Standards Complied:	AS/NZS 60669.2.1, AS/NZS 60669.1, AS/NZS 60950.1, AS/NZS CISPR 15, AS/NZS 4268

0-10V Dimmer Module

Smart 0-10V dimmer for control of LED 0-10V dimmable lighting.



PRODUCT CODE	SAP CODE
DH1-10VIB	5000350

SPECIFICATIONS	
Dimensions:	45 x 45 x 22 mm
Power Supply:	220-240V a.c. 50/60Hz
IP Rating:	IP20
Operating Ambient Temperature:	-20 to 50°C
No Load Standby Power	<1W
Physical Connection:	Terminals
Wiring Connections:	Active, Neutral, 1-10V Dimmer Output & Momentary Mechanism
Momentary Input (T1/T2):	Local signal input only (not 240V a.c.)
Maximum Output Current:	40mA
Maximum Number of Drivers:	30
Dimming Method:	0-10V Dimming
Dimming Range:	0-100%
Housing Material:	Polycarbonate
Standards Complied:	AS/NZS 60669.2.1, AS/NZS 60669.1, AS/NZS CISPR 15, AS/NZS 4268

Warehouse Lighting Control Options

KASTA smart Daylight Sensor and 0-10V Dimmer are used together to achieve daylight harvesting control of LED highbay lighting.

Additionally, the 0-10V Dimmer can be used for wall switch dimming control, multiway and group control, plus automation functions such as setting schedules, timers and custom lighting scenes.

0-10V Dimmer KASTA-D1-10VIBH 5000012



Daylight Sensor KASTA-SL02AB-BH 5000011



SPECIFICATIONS		
Power Supply:	220-240V a.c. 50/60Hz	220-240V a.c. 50/60Hz
Operating Ambient Temperature:	-20 to 50°C	-20 to 50°C
IP Rating:	IP65	IP65
Physical Connection:	3-Pin Plug, Fly Leads	3-Pin Plug
Wiring Connections:	Active, Neutral, Earth (3-Pin Plug), 0-10V Dimmer Output & Momentary Mechanism	Active, Neutral, Earth (3-Pin Plug)
No Load Standby Power:	<1W	<1W
Momentary Input (T1/T2):	Local signal input only (not 240V a.c.)	N/A
Maximum Output Current:	40mA	5mA
Max. Number of:	Drivers = 30	Paired KASTA 0-10V Dimmers = 10
Housing Material:	Polycarbonate	Polycarbonate
Standards Complied:	AS/NZS 60669.2.1, AS/NZS 60669.1, AS/NZS CISPR 15, AS/NZS 4268	AS/NZS 60669.2.1, AS/NZS 60669.1, AS/NZS CISPR 15, AS/NZS 4268



Reliable and robust wireless connectivity

KASTA Bluetooth® mesh network connectivity

Remotely control KASTA devices

Provides remote access to KASTA network

Hands-free control of KASTA devices

Provides voice control functionality via smart speakers



Simple setup and operation

iOS and Android app commissioning and control



CLOUD CONNECT GATEWAY

Easy to set-up. Seamless in integration.

KASTA Cloud Connect Gateway allows remote access of a KASTA network and voice control when used in conjunction with a voice assistant. Utilising multi-protocols to connect, monitor and control KASTA devices, the gateway is the feature-packed upgrade every residential application should include.

PRODUCT RANGE



Product Code	KASTA-CCGW
SAP Code	5000172
Dimension	62 x 62 x 15 mm
Product Colour	White

CONNECTION

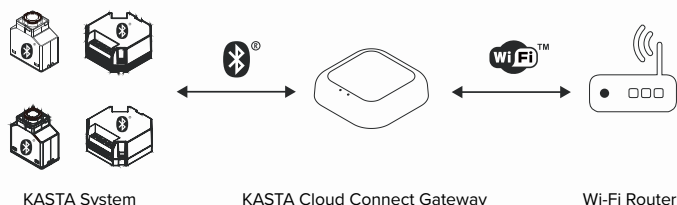

COMMON SPECIFICATIONS

Power Supply	5V d.c. 1A (240V a.c. adaptor included)
Operating Ambient Temperature	-10 to 55°C
IP Rating	IP20
Bluetooth® Connectivity	Qualcomm®, Bluetooth®, CSRmesh™
Wi-Fi Connectivity	Wi-Fi 802.11 g/b/n, 2.4Ghz
No. of supported KASTA systems	1

Connection	Packaged with USB power adaptor and 1m micro-USB cable
Smart Speaker Support	Amazon Echo, Google Home
Scheduling Support	Maintains schedule settings synchronisation
Housing Material	Acylic / Polycarbonate (PC)
LED Indicators	Blue, Red
Standards Complied	AS/NZS 62368.1, AS/NZS 4268, AS/NZS CISPR 32

APPLICATIONS

- Office
- Residential
- Retail Spaces

DIMENSIONS

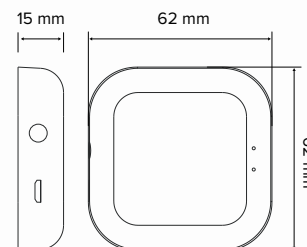

KASTA-CCGW

KASTA App

A simple, intuitive interface allows dynamic live control of all KASTA devices.



Living Enhanced starts at your fingertips - just one touch can take control of your whole home ecosystem.

Compatible on both iOS and Android platforms across all smart phones and tablet devices.

Designed to work seamlessly throughout your home environment, connecting to your smart devices and creating limitless possibilities to personalise and control your space in one simple, intuitive app.

Control and personalise your whole home; opening the garage door, turning lights on, opening curtains, controlling TV power, switching on irrigation, controlling air movement and temperature, and much more.

Find out more



Suitable for use in TS35 DIN
Rails

Flexible Installation



Provides reliable connectivity
and control at the edge of IoT
networks

Seamless Connectivity

Sleep mode and efficient
processor

Low power consumption

 KASTA

PLEXY GATEWAY

A powerful gateway to integrate KASTA with third-party control systems.

KASTA Plexy Gateway provides integration with other third-party automation systems including Control 4, Crestron Home, Rti and Savant.

PRODUCT RANGE



Product Code	KASTA-PGW
SAP Code	5000375
Dimension	133 x 84.5 x 35 mm
Product Colour	Black

COMMON SPECIFICATIONS

Power Supply	12V d.c., 15W Terminals or Barrel Connector	Radio Expansion Socket	XBee socket (SPI and UART)
Operating Ambient Temperature	-10 to 55°C	Ethernet	100BT
Bluetooth® Connectivity	Qualcomm®, Bluetooth® Low Energy 5.0, CSRmesh™	2 Type A Host Ports (USB2.0)	USB type micro-B (CP2102 serial driver)
Wi-Fi Connectivity	Wi-Fi 802.11 a/b/g/n, 2.4 and 5 Ghz	Low Power Modes	15mA "Eco mode", 250uA sleep with RTC wakeup
Processor	Cortex-A53 (ARMv8) 64-bit @ 1.2GHz	Security Controller	OPTIGA™ TPM SLM 9670 - Secure Key Store
Flash	16GB	Battery Backed RTC	Yes, >10 year estimated battery life
RAM	1GB	No. of supported KASTA systems	1
OS/Distribution	Linux / Raspbian (default), Ubuntu, etc.	IP Rating	IP20
LoWPAN Radio 1 (2.4GHz)	MGM13P on-board, software-defined radio - can also support proprietary protocols	Housing Material	Aluminium, Polycarbonate (PC)
		LED Indicators	Blue, Green, Red
		Standards Complied	AS/NZS 4268, AS/NZS CISPR 32

APPLICATIONS

Residential
Multi-Residential

DIMENSIONS

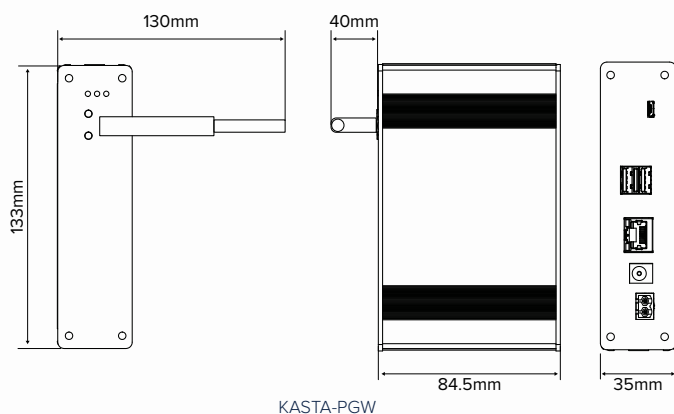

CONNECTION

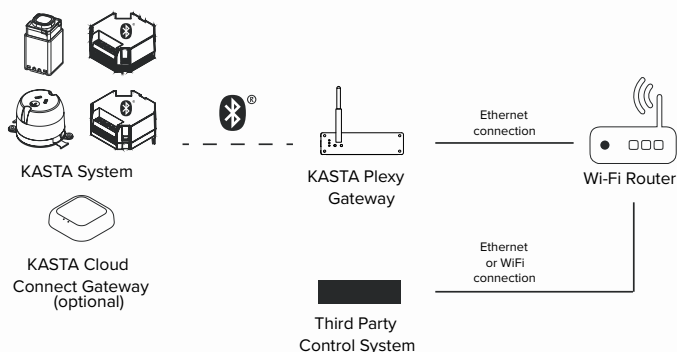

Find out more



**Ultimate flexibility for control
on the move and wherever
you need it**

Portable device

**Dim, adjust colour and more
to create dynamic lighting
environments**

Multi-function control

Convenient mounting option

Magnetic base

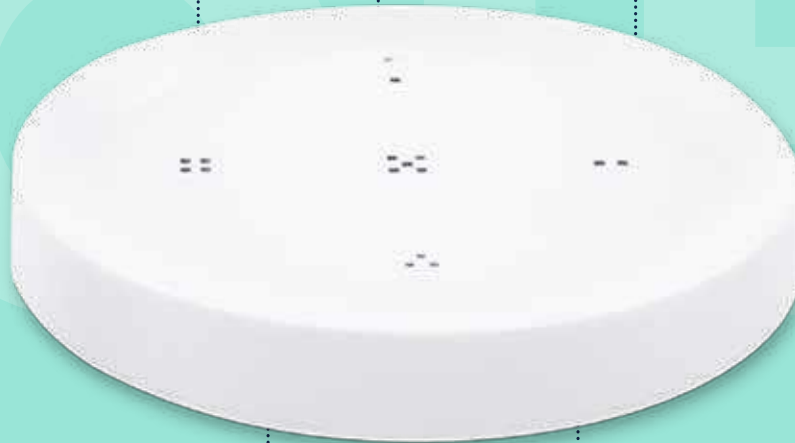

**Provides high end
appearance**

Modernised design

**Customisable control to
adapt to changing needs**

5 re-programmable
buttons

 KASTA

SMART HANDHELD REMOTE

Handheld convenience.

KASTA Battery Powered 5-Button Controller is a portable remote control with a convenient magnetic base, providing flexible mounting and use. Enjoy simple setup and operation through the KASTA app.



BT

Bluetooth 5.0
Mesh Network
Connectivity



IP20

Ingress
Protection
Rating



3yr

Warranty

PRODUCT RANGE



Product Code	KASTA-5BCBH-W
SAP Code	5000064
Dimension	79 x 79 x 13 mm
Product Colour	White

COMMON SPECIFICATIONS

Power Supply	CR2032 Lithium Battery x2 + an additional 2 x CR2032 are included	Mounting	Built-in magnetic base for mounting to metal surfaces
Battery Life	Up to 1 year (approx. 50,000 presses)	Housing Material	Polycarbonate (PC)
Operating Ambient Temperature	0 to 40°C	LED Indicators	Blue (activates on button push)
IP Rating	IP20	Standards Complied	AS/NZS 4268, AS/NZS CISPR 15, AS/NZS 60598.1 (part thereof)

APPLICATIONS

Residential
Commercial
Hospitality

DIMENSIONS

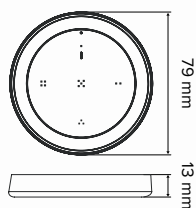

KASTA-5BCBH-W



Find out more





Peace of mind

5 year warranty

Simple installation

3 wire input design

Detects motion over a large area

360° PIR motion detection

Ideal for outdoor applications

IP65 rating

Long lasting body for outdoor installations

Durable UV stabilised polycarbonate

SENTURA

Motion detection.

SENTURA is a ceiling mounted 360° PIR sensor that can pick up movements over a large area with detection range up to 20m. It is ideal for applications such as corridors and carports.



PRODUCT RANGE



Product Code	SENTURA-SMPIR360
SAP Code	2001528
Installation	Ceiling Mount
Dimension	102.5 x 102.5 x 60 mm
Product Colour	White

QUICK FACTS

- Passive Infrared motion sensor
- 3-wire input design for easy installation
- 360° detection
- 10s to 30min time setting
- 3 to 2000lux level setting
- Maximum load: 2000W (Incandescent)
- 1000W (Fluorescent & LED)
- IP65 ingress protection
- 5 year warranty

COMMON SPECIFICATIONS

Installation	Ceiling mount	IP Rating	IP65
Maximum Mounting Height	6 m	Operating Ambient Temperature	-20 to 40°C
Detection Range	Maximum 20m (<24°)	Input Voltage	220-240V, 50/60Hz
Detection Angle	360°	Connection Type	Terminal Block
Time Delay	Minimum 10 seconds (±3 seconds)	Total Weight	0.16 kg
	Maximum 30 minutes (±2 minutes)	Body Material	Polycarbonate
Ambient Light Threshold	<3 to 2000 Lux	Body Colour	White
Maximum Load Wattage	2000W (Incandescent)	Warranty	5yrs
	1000W (Fluorescent & LED)		

APPLICATIONS

- Hallways
- Entrance
- Staircase
- Shed
- Butler Pantry
- Walk-in Wardrobes
- Storage Rooms
- Public Facilities
- Carport

DIMENSIONS

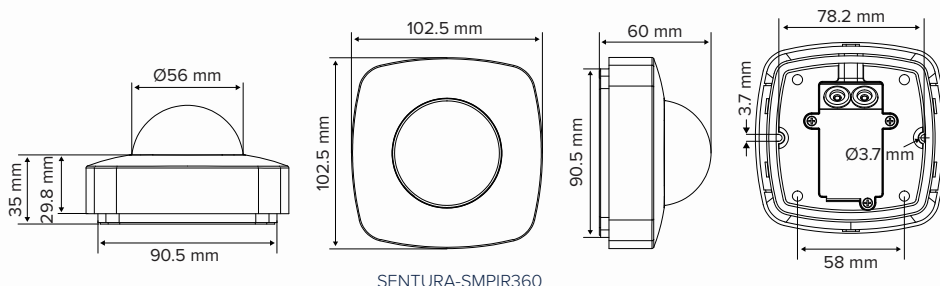

SENSOR DIAGRAM

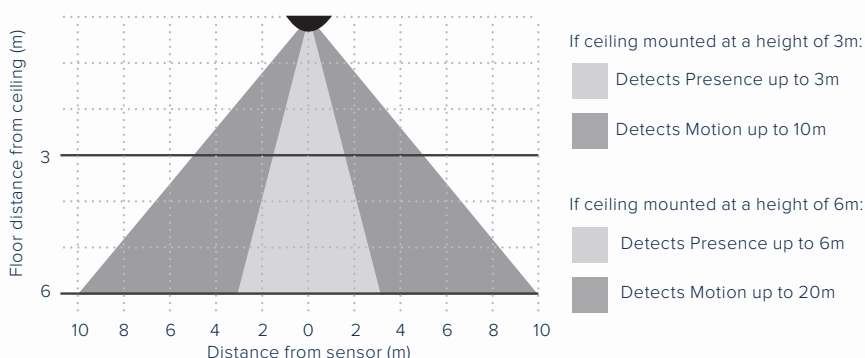

Find out more



Accessories

WHITE AND BLACK COVERS



Product Code	H1RSMB-WH-C	H1RSMB-BK-C
SAP Code	4500537	4500533
Type	KASTA Smart 1-Button Remote Switch, Hesperus, WH-BLANK COVER	KASTA Smart 1-Button Remote Switch, Hesperus, BK-BLANK COVER
Compatible With	H1RSMB-WH	H1RSMB-BK
Product Colour	White	Black



Product Code	H2RSMB-WH-C	H2RSMB-BK-C
SAP Code	4500538	4500534
Type	KASTA Smart 2-Button Remote Switch, Hesperus, WH-BLANK COVER	KASTA Smart 2-Button Remote Switch, Hesperus, BK-BLANK COVER
Compatible With	H2RSMB-WH	H2RSMB-BK
Product Colour	White	Black



Product Code	H3RSMB-WH-C	H3RSMB-BK-C
SAP Code	4500539	4500535
Type	KASTA Smart 3-Button Remote Switch, Hesperus, WH-BLANK COVER	KASTA Smart 3-Button Remote Switch, Hesperus, BK-BLANK COVER
Compatible With	H3RSMB-WH	H3RSMB-BK
Product Colour	White	Black



Product Code	H4RSMB-WH-C	H4RSMB-BK-C
SAP Code	4500540	4500313
Type	KASTA Smart 4-Button Remote Switch, Hesperus, WH-BLANK COVER	KASTA Smart 4-Button Remote Switch, Hesperus, BK-BLANK COVER
Compatible With	H4RSMB-WH	H4RSMB-BK
Product Colour	White	Black



Product Code	H5RSMB-WH-C	H5RSMB-BK-C
SAP Code	4500588	4500314
Type	KASTA Smart 5-Button Remote Switch, Hesperus, WH-BLANK COVER	KASTA Smart 5-Button Remote Switch, Hesperus, BK-BLANK COVER
Compatible With	H5RSMB-WH	H5RSMB-BK
Product Colour	White	Black



Product Code	H6RSMB-WH-C	H6RSMB-BK-C
SAP Code	4500541	4500536
Type	KASTA Smart 6-Button Remote Switch, Hesperus, WH-BLANK COVER	KASTA Smart 6-Button Remote Switch, Hesperus, BK-BLANK COVER
Compatible With	H6RSMB-WH	H6RSMB-BK
Product Colour	White	Black



Motion Sensor Range

VIVA^{SEN}

Motion controlled lighting

PRODUCT CODE	SAP	WATT	DETECTION ANGLE	DETECTION RADIUS	MOUNTING HEIGHT	CUTOUT
VIVA-SEN	2002398	9 W	360°	3 m	3 m	Ø90 mm

MATRIX LG SENSOR

Low glare microprisms

PRODUCT CODE	SAP	WATT	DETECTION ANGLE	DETECTION RADIUS	MOUNTING HEIGHT	LENGTH
MTRX0312-25-LG-S	2002449	25 W	360°	Ceiling Mounting @ 3m = 5 m	2.4 - 3.6 m	1195 mm

VISTA^{MS}

Simple, efficient and flexible

PRODUCT CODE	SAP	WATT	DETECTION ANGLE	DETECTION RADIUS	MOUNTING HEIGHT	LENGTH
VISTA12-SS	2002232	18 / 36 W	360°	Ceiling Mounting @ 3m = 5-7m	3-6 m	1221 mm

VISTA^{HERO MS}

Conventional and elegant

PRODUCT CODE	SAP	WATT	DETECTION ANGLE	DETECTION RADIUS	MOUNTING HEIGHT	LENGTH
VISTA-HR12-MS	2001942	20 / 40 W	360°	Ceiling Mounting @ 3m = 5 m	3-6 m	1165 mm
VISTA-HR12-EM-MS	2001943	20 / 40 W	360°	Ceiling Mounting @ 3m = 5 m	3-6 m	1165 mm

VISTA^{EVO MS}

Well rounded LED batten

PRODUCT CODE	SAP	WATT	DETECTION ANGLE	DETECTION RADIUS	MOUNTING HEIGHT	LENGTH
VISTA-EV12-MS	2002350	20 / 40 W	360°	Ceiling Mounting @3m = 4m	3-6 m	1205 mm
VISTA-EV12-MS-BK	2002356	20 / 40 W	360°	Ceiling Mounting @3m = 4m	3-6 m	1205 mm
VISTA-EV12-EM-MS	2002351	20 / 40 W	360°	Ceiling Mounting @3m = 4m	3-6 m	1205 mm
VISTA-EV12-EM-MS-BK	2002357	20 / 40 W	360°	Ceiling Mounting @3m = 4m	3-6 m	1205 mm

OXFORD^{MS}

Aesthetically pleasing, wide-body batten

PRODUCT CODE	SAP	WATT	DETECTION ANGLE	DETECTION RADIUS	MOUNTING HEIGHT	LENGTH
OXFORD12-MS	2001887	40 W	360°	Ceiling Mounting @ 3m = 5 m	3-6 m	1165 mm
OXFORD12-EM-MS	2001888	40 W	360°	Ceiling Mounting @ 3m = 5 m	3-6 m	1165 mm

DURA^{MS}

Robust construction for harsh environments

PRODUCT CODE	SAP	WATT	DETECTION ANGLE	DETECTION RADIUS	MOUNTING HEIGHT	LENGTH
DURA-06-MS	2002140	10 / 13 / 15 / 18 W	360°	Ceiling Mounting @ 3m = 3 m	3-6 m	655 mm
DURA-06-EM-MS	2002141	10 / 13 / 15 / 18 W	360°	Ceiling Mounting @ 3m = 3 m	3-6 m	655 mm
DURA-12-MS	2002144	18 / 25 / 30 / 36 W	360°	Ceiling Mounting @ 3m = 3 m	3-6 m	1220 mm
DURA-12-EM-MS	2002145	18 / 25 / 30 / 36 W	360°	Ceiling Mounting @ 3m = 3 m	3-6 m	1220 mm

TRIPROOF^{G2 MS}

Tried and trusted design

PRODUCT CODE	SAP	WATT	DETECTION ANGLE	DETECTION RADIUS	MOUNTING HEIGHT	LENGTH
TRIPROOF12-MS	2002553	18 / 24 / 32 / 38 W	360°	4 m @3 m height Ceiling mount	3-6 m	1220 mm
TRIPROOF12-MS-EM	2002555	18 / 24 / 32 / 38 W	360°	4 m @3 m height Ceiling mount	3-6 m	1220 mm

PURO^{G4 MS}

General purpose oyster lighting

PRODUCT CODE	SAP	WATT	DETECTION ANGLE	DETECTION RADIUS	MOUNTING HEIGHT	DIAMETER
PURO14W-300R-MS	2002373	8 / 10 / 11 / 15 W	360°	Ceiling Mounting @ 3m = 3.5-5m	3-4 m	Ø300 mm
PURO18W-350R-MS	2002375	9 / 12 / 18 W	360°	Ceiling Mounting @ 3m = 3.5-5m	3-4 m	Ø350 mm
PURO24W-400R-MS	2002377	11 / 15 / 23 W	360°	Ceiling Mounting @ 3m = 3.5-5m	3-4 m	Ø400 mm
PURO25W-EM-MS	2001991	25 W	360°	Ceiling Mounting @ 3m = 3.5-5m	3-4 m	Ø400 mm

Motion Sensor Range

DISCUS^{MS}

Super slim profile

PRODUCT CODE	SAP	WATT	DETECTION ANGLE	DETECTION RADIUS	MOUNTING HEIGHT	DIAMETER
DISC25W300R-MS	2001937	25 W	360°	Ceiling Mounting @ 3m = 5m	3-6 m	Ø300 mm
DISC25W-EM-MS	2001938	25 W	360°	Ceiling Mounting @ 3m = 5m	3-6 m	Ø300 mm

DAWN^{MS}

Contemporary and versatile

PRODUCT CODE	SAP	WATT	DETECTION ANGLE	DETECTION RADIUS	MOUNTING HEIGHT	DIAMETER
DN16WOVL-TRI-MS	2001909	16 W	360°	Ceiling Mounting @ 3m = 6 -8m Wall Mounting @ 2m = 7 - 9m	3-6 m	280 mm
DN20WRND-TRI-MS	2001910	20 W	360°	Ceiling Mounting @ 3m = 6 -8m Wall Mounting @ 2m = 7 - 9m	3-6 m	Ø275 mm
DN20WRND-TRI-MS-EM	2001912	20 W	360°	Ceiling Mounting @ 3m = 6 -8m Wall Mounting @ 2m = 7 - 9m	3-6 m	Ø275 mm
DN30WRND-TRI-MS	2001913	30 W	360°	Ceiling Mounting @ 3m = 6 -8m Wall Mounting @ 2m = 7 - 9m	3-6 m	Ø350 mm
DN30WRND-TRI-MS-EM	2001915	30 W	360°	Ceiling Mounting @ 3m = 6 -8m Wall Mounting @ 2m = 7 - 9m	3-6 m	Ø350 mm

DAWN^{HERO MS}

Sleek, beautiful and tough

PRODUCT CODE	SAP	WATT	DETECTION ANGLE	DETECTION RADIUS	MOUNTING HEIGHT	DIAMETER
DN13WHR-MS	2002288	10 / 14 W	360°	Ceiling Mounting @ 3m = 3.5 -5m Wall Mounting @ 2m = 7 - 9m	3-6 m	Ø300
DN13WHR-MS-EM	2002290	12 / 16 W	360°	Ceiling Mounting @ 3m = 3.5 -5m Wall Mounting @ 2m = 7 - 9m	3-6 m	Ø300

