

SURFACE SOCKET .....	306
QIKFIT <sup>G2</sup> .....	308
HESPERUS™ UNISON SWITCHES .....	310
HESPERUS™ UNISON POWERPOINTS .....	314
EDGY™ UNISON SWITCHES .....	316
EDGY™ UNISON POWERPOINTS .....	320
UNISON MECHANISMS .....	322
ROCKER SWITCH MECHANISMS .....	322
USB MECHANISMS .....	323
DATA & COMMS MECHANISMS .....	323
ATMOS™ UNISON SWITCHES .....	324
ATMOS™ UNISON POWERPOINTS .....	325



# SWITCHES AND SOCKETS



GPO Marriott Adelaide



GPO Marriott Adelaide

**Suits common plugs**

Flat 2 pin or 3 pin compatible

**Easy viewing of connections**

Clear nail plate



**Conventional wiring**

Large A, N, E, LOOP terminals

**Multi-directional installation**

Clean precision break-out for TPS cabling

## SURFACE SOCKET

**Compact and reliable.**

A compact white Single Surface Socket rated at 10A, 250V a.c. It can accept standard two or three pin flat plugs that are commonly attached to popular downlights or lighting loads.



## PRODUCT RANGE



Product Code	<b>SS310-WH</b>
SAP Code	2001933
Dimensions	90 x 65 x 54 mm
Product Colour	White

## COMMON SPECIFICATIONS

<b>Maximum Load Wattage</b>	2400 W	<b>Cable Size</b>	Terminals to accept up to 4 x 2.5mm cables
<b>Nail Plate Colour</b>	Transparent	<b>Mounting Type</b>	Inline and end of line
<b>Diameter</b>	66 mm	<b>Cutout</b>	Suits Ø90mm cutout
<b>Current Rating</b>	10A	<b>Connection Type</b>	Terminals
<b>Input Voltage</b>	10A, 250V a.c. 3-pins	<b>Fixing Points</b>	External tabs for cable ties, clouts and screws
<b>IP Rating</b>	IP20	<b>Connection Type</b>	Terminals
<b>Operating Ambient Temperature</b>	-20 to 50°C	<b>Warranty</b>	5 yrs

## APPLICATIONS

Bedrooms  
Lounge Room  
Dining Area  
Hallways  
Ensuite  
Entrance  
Kitchen / Food Prem  
Garage  
Storage Facilities  
Boardroom / Meeting Rooms  
Medical Facilities  
Restaurants / Cafes  
Retail Spaces  
Hotel Common Areas  
Hotel Rooms

## DIMENSIONS

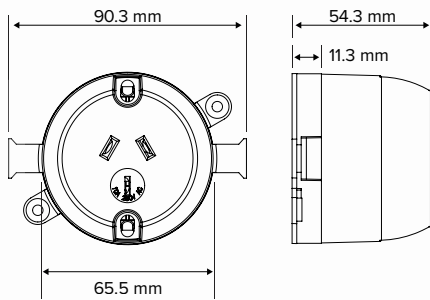

SS310-WH

## CONNECTION

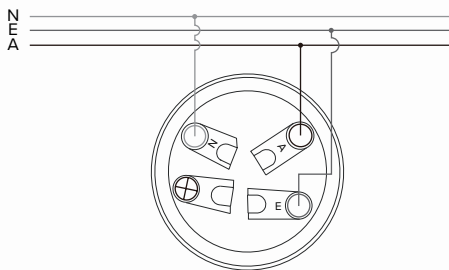

Find out more



Suits common plugs

3-pin socket



Rapid install

Quick connection method

Assist plug insertion in ceiling space

Earth pin divet

G2

## QIKFIT<sup>G2</sup>

Quick connect.

The QIKFIT G2 Surface Socket stands out for its quick connect feature, which significantly simplifies and speeds up the installation process. It also accommodates a wide conductor range and can terminate up to two sets of Active, Neutral and Earth Conductors.



## PRODUCT RANGE



Product Code	<b>QIKFIT2.0</b>
SAP Code	2002359
Dimensions	69 x 48 x 45 mm (suits 70 mm cutout - no plug)
Product Colour	Off-White
Weight	0.05 kg

## COMMON SPECIFICATIONS

Maximum Load Wattage	2400 W	Operating Ambient Temperature	-20 to 50°C
IP Rating	IP20	Input Voltage	10A, 250V a.c. 3-pins
Cable Size	1.0 mm <sup>2</sup> to 2.5 mm <sup>2</sup> TPS	Fixing Points	External tabs for cable ties, clouts and screws
Mounting Type	Inline and end of line	Warranty	3 yrs
Cutout	Suits Ø70mm cutout		
Finish	Matte		

## APPLICATIONS

Bedrooms  
Lounge Room  
Dining Area  
Hallways  
Ensuite  
Entrance  
Kitchen / Food Prem  
Garage  
Storage Facilities  
Boardroom / Meeting Rooms  
Medical Facilities  
Restaurants / Cafes  
Retail Spaces  
Hotel Common Areas  
Hotel Rooms

## DIMENSIONS

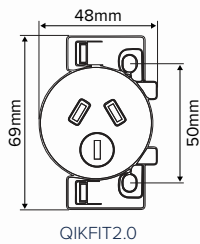

## CONNECTION

### INLINE CONNECTION

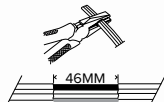
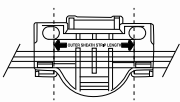

### END OF LINE CONNECTION

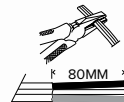

1. Measure and strip the cable 46mm for an inline connection or 80mm for an end of line connection. Conductor Range 1.0mm<sup>2</sup> to 2.5mm<sup>2</sup> solid/stranded to AS/NZS5000. DO NOT use for conductors outside this range.

### INLINE CONNECTION

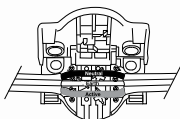

### END OF LINE CONNECTION

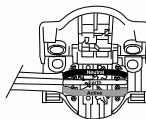

2. Put the cables into the slots according to the indicated colours as shown to ensure correct polarity.  
Note: When completing an end of line connection, place tails into individual cavities.

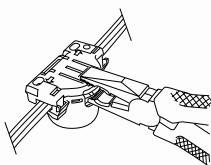

3. Tightly squeeze the cover with pliers as shown until both clips latch.

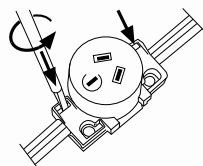

4. If required, re-open by inserting flat blade screwdriver and twist to release both clips.  
Note: To ensure adequate connection, do not reinstall in the same position on the cable.

Find out more





**Premium luxury finish**

Slim (9.8mm plate depth)  
glass-look design

**Avoid plate discolouration**

UV stabilised

**Fast installation**

Flush mounting centres  
(not recessed)

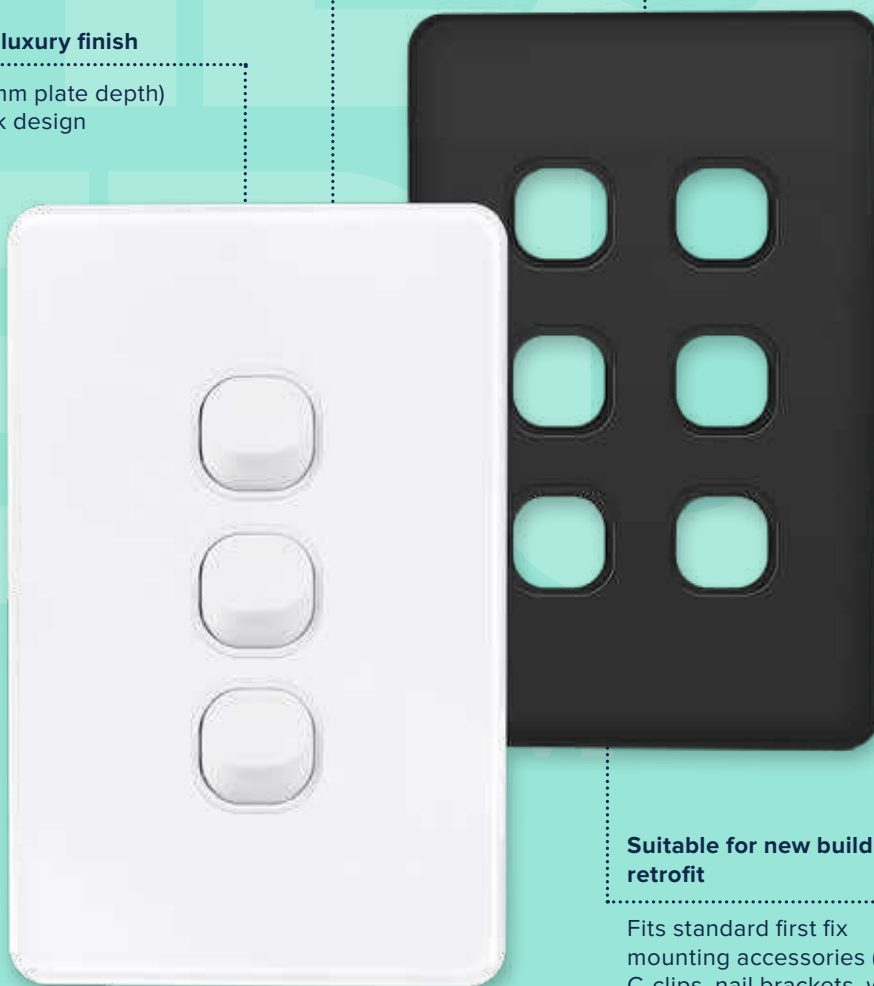

**Suitable for new build or retrofit**

Fits standard first fix  
mounting accessories (e.g.  
C-clips, nail brackets, wall  
boxes)

**Maximum compatibility**

Switch apertures  
acceptive of KASTA  
mechanisms

# HESPERUS™ UNISON SWITCHES

A range of premium luxury switches and powerpoints.

The Hesperus™ Series of Unison™ switches feature a modern, slim design with a luxury glass-look finish. These switches will instantly upgrade interior spaces and have the option of being simply retrofit to existing wall mount accessories.



IP20  
Ingress  
Protection  
Rating



INSTALL  
Easy  
Installation



RANGE  
Extensive  
Product  
Range



5yr  
Warranty

**PRODUCT RANGE**

## Hesperus™ Unison

### Grid Plates and Covers

1 to 6-button grid plates and covers for use with KASTA mechanisms.



A wide range of Pictogram Button Caps are available to choose from to suit KASTA smart mechanisms that fit into Hesperus™ and Edgy™ Series grid plate and covers.

SPECIFICATIONS	
Dimensions	120 x 80 x 9.8mm
Plate Depth	9.8mm
IP Rating	IP20
Terminal Size	4.1mm bore (accommodates 4x1.5mm <sup>2</sup> cables)
Terminal Screw Type	Flat Terminal Screw
Mounting Points	84mm / 103mm and Corners
Mounting Screw Type	Combination Flat / Philips Head Screws
Frame Colour (Finish)	Black (Gloss)
Plate Colour (Finish)	White / Black (Gloss)
Housing Material	Acrylic / Polycarbonate

PLATE COLOUR	PRODUCT CODE	SAP CODE
White	H1SVH-WH	5000359
Black	H1SVH-BK	5000365
White	H2SVH-WH	5000360
Black	H2SVH-BK	5000366
White	H3SVH-WH	5000361
Black	H3SVH-BK	5000367
White	H4SVH-WH	5000362
Black	H4SVH-BK	5000368
White	H5SVH-WH	5000363
Black	H5SVH-BK	5000369
White	H6SVH-WH	5000364
Black	H6SVH-BK	5000370

## Hesperus™ Unison

### Assembled Switches

1 to 6-button vertical assembled switches.



SPECIFICATIONS	
Dimensions	120 x 80 x 27.4mm
Plate Depth	9.8mm
Power Supply	220-240V a.c.
IP Rating	IP20
Current Rating	10A
Operating Ambient Temperature	-20 to 40°C
Terminal Size	4.1mm bore (accommodates 4x1.5mm <sup>2</sup> cables)
Terminal Screw Type	Flat Terminal Screw
Mounting Points	84mm / 103mm and Corners
Mounting Screw Type	Combination Flat / Philips Head Screws
Frame Colour (Finish)	Black (Gloss)
Plate Colour (Finish)	White / Black (Gloss)
Housing Material	Acrylic / Polycarbonate
Standards Complied	AS/NZS 3100, AS/NZS 3133

PLATE COLOUR	PRODUCT TYPE	PRODUCT CODE	SAP CODE
White	Vertical	H1ASV-WH	5000198
Black	Vertical	H1ASV-BK	5000199
White	Vertical	H2ASV-WH	5000201
Black	Vertical	H2ASV-BK	5000202
White	Vertical	H3ASV-WH	5000204
Black	Vertical	H3ASV-BK	5000205
White	Vertical	H4ASV-WH	5000207
Black	Vertical	H4ASV-BK	5000208
White	Vertical	H5ASV-WH	5000210
Black	Vertical	H5ASV-BK	5000211
White	Vertical	H6ASV-WH	5000213
Black	Vertical	H6ASV-BK	5000214

Find out more



**PRODUCT RANGE**

**Hesperus™ Unison™**  
Assembled Switches

1 to 6-button horizontal assembled switches.



**SPECIFICATIONS**

Dimensions	120 x 80 x 27.4mm
Plate Depth	9.8mm
Power Supply	220-240V a.c.
IP Rating	IP20
Current Rating	10A
Operating Ambient Temperature	-20 to 40°C
Terminal Size	4.1mm bore (accommodates 4x1.5mm <sup>2</sup> cables)
Terminal Screw Type	Flat Terminal Screw
Mounting Points	84mm / 103mm and Corners
Mounting Screw Type	Combination Flat / Philips Head Screws
Frame Colour (Finish)	Black (Gloss)
Plate Colour (Finish)	White / Black (Gloss)
Housing Material	Acrylic / Polycarbonate
Standards Complied	AS/NZS 3100, AS/NZS 3133

PLATE COLOUR	PRODUCT TYPE	PRODUCT CODE	SAP CODE
White	Horizontal	H1ASH-WH	7500133
Black	Horizontal	H1ASH-BK	7500134
White	Horizontal	H2ASH-WH	7500136
Black	Horizontal	H2ASH-BK	7500135
White	Horizontal	H3ASH-WH	7500138
Black	Horizontal	H3ASH-BK	7500137
White	Horizontal	H4ASH-WH	7500140
Black	Horizontal	H4ASH-BK	7500139
White	Horizontal	H5ASH-WH	7500142
Black	Horizontal	H5ASH-BK	7500141
White	Horizontal	H6ASH-WH	7500144
Black	Horizontal	H6ASH-BK	7500143





**Avoid plate discolouration**

UV stabilised

**Fast installation**

Flush mounting centres  
(not recessed)

**Premium luxury finish**

Slim (9.8mm plate depth)  
glass-look design

**Suitable for new build or retrofit**

Fits standard first fix mounting  
accessories (e.g. C-clips, nail  
brackets, wall boxes)

**Maximum compatibility**

Switch apertures acceptive  
of KASTA mechanisms

# HESPERUS™ UNISON POWERPOINTS

A range of premium luxury switches and powerpoints.

The Hesperus™ Series of Unison™ 10A powerpoints also feature a modern, slim design with a luxury glass-look finish that's completed with complementary gloss-finish sockets. These powerpoints are offered in a range of configurations and include many design features to enhance aesthetics, ease of installation and ensure safety.



PRODUCT RANGE

# Hesperus™ Unson Powerpoints

A complementary range of 240V powerpoints to suit a wide variety of power outlet and data input requirements.

Choose from single or double configurations and horizontal or vertical orientations, a variety of extra aperture options, and white or black plate colours.



SPECIFICATIONS	
Dimensions	121 x 80 x 44mm
Plate Depth	9.8mm
Power Supply	220-240V a.c. 50Hz
Operating Ambient Temperature	-20 to 40°C
IP Rating	IP20
Current Rating	10A
Energy Monitor	0.01A to 10A
Terminal Size	16mm <sup>2</sup> (accommodates 4x2.5mm <sup>2</sup> cables)
Terminal Screw Type	Combination Flat / Philips Head Screws
Mounting Points	84mm / 100mm and Corners
Mounting Screw Type	Combination Flat / Philips Head Screws
Frame Colour (Finish)	Black (Gloss)
Plate Colour (Finish)	White / Black (Gloss)
Housing Material	Acrylic / Polycarbonate
Standards Complied	CoS SAA 183650, AS/NZS 60669.2.1, AS/NZS 60669.1, AS/NZS CISPR 15, AS/NZS 4268

PLATE COLOUR	PRODUCT TYPE	PRODUCT CODE	SAP CODE
White	Horizontal	H1PPH-WH	5000078
Black	Horizontal	H1PPH-BK	5000217
White	Horizontal	H2PPH-WH	5000219
Black	Horizontal	H2PPH-BK	5000220
White	Horizontal	H2PPHXA-WH	5000373
Black	Horizontal	H2PPHXA-BK	5000374
White	Horizontal	H2PPHX-WH	5000371
Black	Horizontal	H2PPHX-BK	5000372
White	Horizontal	H2PPHU2AC-WH	7500148
Black	Horizontal	H2PPHU2AC-BK	7500149

Find out more



**Contemporary design based on traditional classic shape**

Modern, slim (7.8mm plate depth)

**For quicker installation**

Flush mounting centres (not recessed)

**Avoid plate discolouration**

UV stabilised

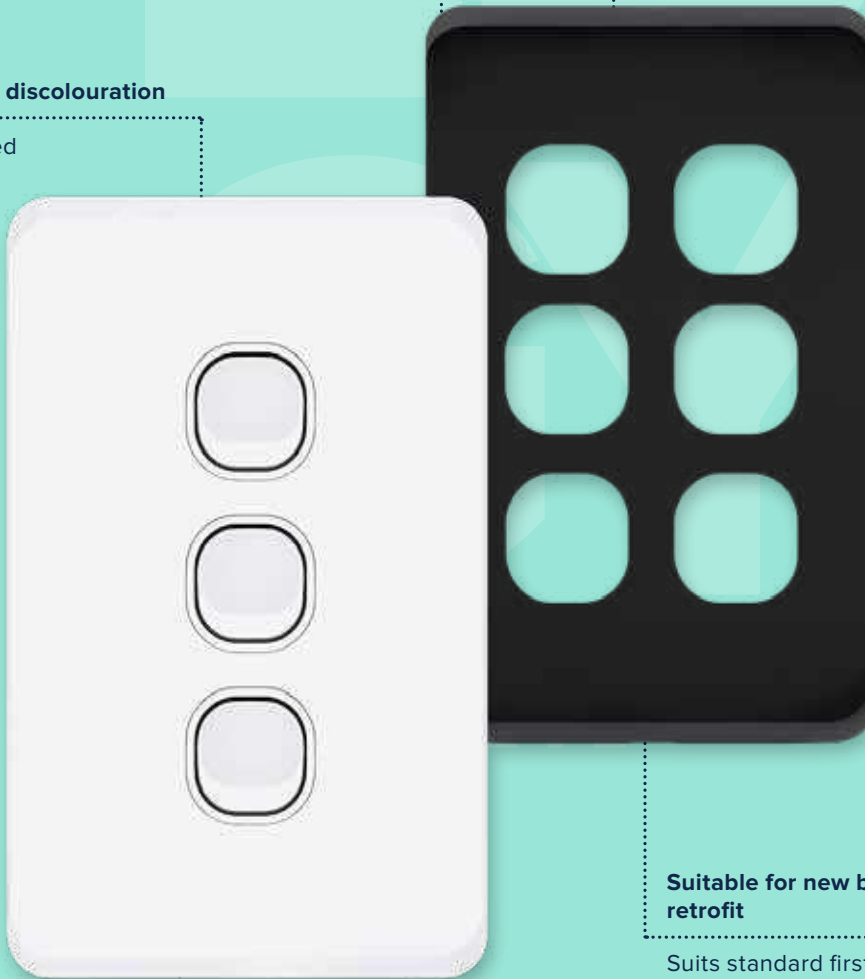

**Flexible, modular installations**

Switch apertures acceptive of KASTA mechanisms and traditional 30 Series\* mechanism designs

**Suitable for new build or retrofit**

Suits standard first fix mounting accessories (e.g. C-clips, nail brackets, wall boxes)



# EDGY™ UNISON SWITCHES

A range of contemporary switches and powerpoints.

Edgy™ Series of switches features a slim, clean design with modern bevelled edges that easily blends into today's modern environments, décor and lifestyles.



**PRODUCT RANGE**

**Edgy™ Unison**  
Grid Plates and Covers

1 to 6-button grid plates and covers for use with KASTA mechanisms.

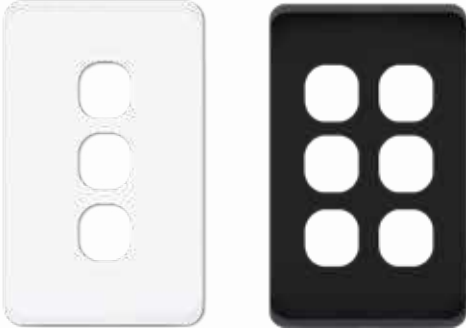

A wide range of Pictogram Button Caps are available to choose from to suit KASTA smart mechanisms that fit into Hesperus™ and Edgy™ Series grid plate and covers.

SPECIFICATIONS	
Dimensions	120 x 78 x 7.8mm
Plate Depth	7.8mm
IP Rating	IP20
Terminal Size	4.1mm bore (accommodates 4x1.5mm <sup>2</sup> cables)
Terminal Screw Type	Flat Terminal Screw
Mounting Points	84mm / 103mm and Corners
Mounting Screw Type	Combination Flat / Philips Head Screws
Plate Colour (Finish)	White (Gloss) / Black (Matte)
Housing Material	Polycarbonate

PLATE COLOUR	PRODUCT CODE	SAP CODE
White	EG1V-WH	5000279
Black	EG1V-MBK	5000280
White	EG1SVH-WH	5000111
Black	EG1SVH-MBK	5000281
White	EG2SVH-WH	5000112
Black	EG2SVH-MBK	5000282
White	EG3SVH-WH	5000113
Black	EG3SVH-MBK	5000283
White	EG4SVH-WH	5000114
Black	EG4SVH-MBK	5000284
White	EG5SVH-WH	5000115
Black	EG5SVH-MBK	5000285
White	EG6SVH-WH	5000116
Black	EG6SVH-MBK	5000286

**Edgy™ Unison**  
Assembled Switches

1 to 6-button vertical assembled switches.



SPECIFICATIONS	
Dimensions	120 x 80 x 27mm
Plate Depth	7.8mm
Power Supply	220-240V a.c.
IP Rating	IP20
Current Rating	10A
Operating Ambient Temperature	-20 to 40°C
Terminal Size	4.1mm bore (accommodates 4x1.5mm <sup>2</sup> cables)
Terminal Screw Type	Flat Terminal Screw
Mounting Points	84mm / 103mm and Corners
Mounting Screw Type	Combination Flat / Philips Head Screws
Plate Colour (Finish)	White (Gloss) / Black (Matte)
Housing Material	Polycarbonate
Standards Complied	AS/NZS 3100, AS/NZS 3133

PLATE COLOUR	PRODUCT TYPE	PRODUCT CODE	SAP CODE
White	Vertical	EG1ASV-WH	5000117
Black	Vertical	EG1ASV-MBK	5000273
White	Vertical	EG2ASV-WH	5000118
Black	Vertical	EG2ASV-MBK	5000274
White	Vertical	EG3ASV-WH	5000119
Black	Vertical	EG3ASV-MBK	5000275
White	Vertical	EG4ASV-WH	5000120
Black	Vertical	EG4ASV-MBK	5000276
White	Vertical	EG5ASV-WH	5000121
Black	Vertical	EG5ASV-MBK	5000277
White	Vertical	EG6ASV-WH	5000122
Black	Vertical	EG6ASV-MBK	5000278

Find out more





**PRODUCT RANGE**

**Edgy™ Unison**  
Assembled Switches

1 to 6-button horizontal assembled switches.



**SPECIFICATIONS**

Dimensions	120 x 80 x 27mm
Plate Depth	7.8mm
Power Supply	220-240V a.c.
IP Rating	IP20
Current Rating	10A
Operating Ambient Temperature	-20 to 40°C
Terminal Size	4.1mm bore (accommodates 4x1.5mm <sup>2</sup> cables)
Terminal Screw Type	Flat Terminal Screw
Mounting Points	84mm / 103mm and Corners
Mounting Screw Type	Combination Flat / Philips Head Screws
Plate Colour (Finish)	White (Gloss) / Black (Matte)
Housing Material	Polycarbonate
Standards Complied	AS/NZS 3100, AS/NZS 3133

PLATE COLOUR	PRODUCT TYPE	PRODUCT CODE	SAP CODE
White	Horizontal	EG1ASH-WH	5000287
Black	Horizontal	EG1ASH-MBK	5000288
White	Horizontal	EG2ASH-WH	5000289
Black	Horizontal	EG2ASH-MBK	5000290
White	Horizontal	EG3ASH-WH	5000291
Black	Horizontal	EG3ASH-MBK	5000292
White	Horizontal	EG4ASH-WH	5000293
Black	Horizontal	EG4ASH-MBK	5000294
White	Horizontal	EG5ASH-WH	5000295
Black	Horizontal	EG5ASH-MBK	5000296
White	Horizontal	EG6ASH-WH	5000297
Black	Horizontal	EG6ASH-MBK	5000298



**Contemporary design based on traditional classic shape**

Modern, slim (7.8mm plate depth)

**For quicker installation**

Flush mounting centres (not recessed)

**Avoid plate discolouration**

UV stabilised



**Flexible, modular installations**

Switch apertures acceptive of KASTA mechanisms and traditional 30 Series\* mechanism designs

**Suitable for new build or retrofit**

Suits standard first fix mounting accessories (e.g. C-clips, nail brackets, wall boxes)



# EDGY™ UNISON POWERPOINTS

A range of contemporary switches and powerpoints.

Edgy™ Series of powerpoints feature a slim, clean design with modern bevelled edges that easily blends into today's modern environments, décor and lifestyles.



## PRODUCT RANGE

# Edgy™ Unison Powerpoints

A complementary range of 240V powerpoints to suit a wide variety of power outlet and data input requirements.

Choose from single or double configurations, 10A or 15A power supply, horizontal or vertical orientations, a variety of extra aperture options, and white or matte black plate colours.



### SPECIFICATIONS

Dimensions	121 x 80 x 44mm
Plate Depth	7.8mm
Power Supply	220-240V a.c. 50Hz
Operating Ambient Temperature	-20 to 40°C
IP Rating	IP20
Current Rating	10 / 15A
Energy Monitor	0.01A to 10A
Terminal Size	16mm <sup>2</sup> (accommodates 4x2.5mm <sup>2</sup> cables)
Terminal Screw Type	Combination Flat / Philips Head Screws
Mounting Points	84mm / 100mm and Corners
Mounting Screw Type	Combination Flat / Philips Head Screws
Plate Colour (Finish)	White (Gloss) / Black (Matte)
Housing Material	Polycarbonate
Standards Complied	CoS SAA 183650, AS/NZS 60669.2.1, AS/NZS 60669.1, AS/NZS CISPR 15, AS/NZS 4268

PLATE COLOUR	PRODUCT TYPE	PRODUCT CODE	SAP CODE
White	Vertical	EG1PPV-WH	5000313
Black	Vertical	EG1PPV-MBK	5000314
White	Vertical	EG2PPV-WH	5000315
Black	Vertical	EG2PPV-MBK	5000316
White	Horizontal	EG1PPH-WH	5000123
Black	Horizontal	EG1PPH-MBK	5000299
White	Horizontal	EG1PPHXA-WH	5000300
Black	Horizontal	EG1PPHXA-MBK	5000301
White	Horizontal	EG1PP15H-WH	5000302
Black	Horizontal	EG1PP15H-MBK	5000303
White	Horizontal	EG2PPH-WH	5000124
Black	Horizontal	EG2PPH-MBK	5000304
White	Horizontal	EG2PPHXA-WH	5000126
Black	Horizontal	EG2PPHXA-MBK	5000308
White	Horizontal	EG2PPHX-WH	5000125
Black	Horizontal	EG2PPHX-MBK	5000307
White	Horizontal	EG2PPHU2AC-WH	7500146
Black	Horizontal	EG2PPHU2AC-MBK	7500147

Find out more



# MECHANISMS

Unison™, Data and Communications



## Unison™ mechanisms to complement KASTA's smart range.

KASTA offers a range of Unison™ mechanisms that clip into a standard wall switch plate for complete installation flexibility. Suitable for use in residential and commercial projects. The range includes push button, rocker switch mechanisms as well as a wide range of data and communication mechanisms. Suits both Hesperus™ and Edgy™ Series plates.

These products fit into KASTA's range of Unison™ grid plate and covers. See page 311 for Hesperus™ Unison™ Data Grid Plate and Covers or page 317 for Edgy™ Unison™ Grid Plate and Covers.

### Features

- Multiple installation options
- Over-current / over-voltage protection

### Benefit

- Increased safety
- Quick and easy installation, suitable for retrofitting

## Unison™ Mechanisms

### Rocker Switch



MR10-WH MRD10-WH MRD35-WH MRD35HOB-WH MRMPRESS-WH MRINT10-WH

PRODUCT TYPE	COLOUR	PRODUCT CODE	SAP CODE
Single Pole 1/2 way 10AX 250V	White	MR10-WH	5000127
	Black	MR10-BK	5000332
	Black (Matte)	MR10-MBK	5000490
Double Pole 1 way 10AX 250V	White	MRD10-WH	5000128
	Black	MRD10-BK	4500578
	Black (Matte)	MRD10-MBK	5000469
Double Pole 1 way 35A 250V	White	MRD35-WH	5000129
	Black	MRD35-BK	4500579
	Black (Matte)	MRD35-MBK	5000470
Double Pole 1 way 35A 250V marked 'HOB'	White	MRD35HOB-WH	5000130
	Black	MRD35HOB-BK	4500580
	Black (Matte)	MRD35HOB-MBK	5000491
Single Pole 1 way 10AX 250V marked 'PRESS'	White	MRMPRESS-WH	5000131
	Black	MRMPRESS-BK	4500581
	Black (Matte)	MRMPRESS-MBK	5000471
Intermediate, 10A, 250V	White	MRINT10-WH	5000487
	Black	MRINT10-BK	4500587
	Black (Matte)	MRINT10-MBK	5000488

### Push Button



PRODUCT CODE	SAP CODE
MEPBL51440-WH	5000196

## Data and Communications Mechanisms



MHDMI-WH MRJ45C6-WH MRJ11-WH MTVC-WH MTFV-WH

PRODUCT TYPE	COLOUR	PRODUCT CODE	SAP CODE
HDMI	White	MHDMI-WH	5000337
	Black	MHDMI-BK	4500582
	Black (Matte)	MHDMI-MBK	5000492
RJ45, CAT6	White	MRJ45C6-WH	5000254
	Black	MRJ45C6-BK	4500583
	Black (Matte)	MRJ45C6-MBK	5000493
RJ11, TEL	White	MRJ11-WH	5000342
	Black	MRJ11-BK	4500584
	Black (Matte)	MRJ11-MBK	5000494
TV, Coaxial	White	MTVC-WH	5000344
	Black	MTVC-BK	4500585
	Black (Matte)	MTVC-MBK	5000495
TV, F Type	White	MTVF-WH	5000346
	Black	MTVF-BK	4500586
	Black (Matte)	MTVF-MBK	5000496



MU2AC-WHBKMBK

PRODUCT TYPE	COLOUR	PRODUCT CODE	SAP CODE
KASTA Unison™ USB Mechanism	White/ Black/ Matte Black	MU2AC- WHBKMBK	5000432

Find out more



## A range of weatherproof switches and powerpoints.

The Atmos Weatherproof series of switches and powerpoints are perfect for exterior applications, and they are rated at IP54 or 66 and built to last. Perfect for patio or outdoor barbeque areas. The range provides ample conduit entries and is suitable for side-entry from a vertical duct. Its compact size means it is aesthetically pleasing and suits installations where space is limited, such as with residential air conditioning, outdoor lighting and small motor control.

### Features

- Multiple installation options
- Large terminals

### Benefit

- Quick and easy installation, suitable for retrofitting
- Allows 4 x 2.5mm<sup>2</sup> cables

## KASTA Unison Atmos Isolating Switches

Unison Atmos Weatherproof Switches, S20A, 35A, 63A, 1 pole or 3 pole.



PRODUCT CODE	THERMAL CURRENT RATING	SAP CODE
ISLS20A1P	20A	5000461
ISLS20A3P	20A	5000458
ISLS35A1P	35A	5000462
ISLS35A3P	35A	5000459
ISLS63A1P	63A	5000463
ISLS63A3P	63A	5000460

SPECIFICATIONS	
Isolating Switch	Suitable for isolation
Rated Operational Voltage	250VAC(1P) / 500VAC(3P), 50Hz
Dimensions	82.5 x 173 x 87.5 mm
IP Rating	IP66
Rated Insulation Voltage (Ui)	500V
Rated impulse withstand voltage (Uimp)	4kV
Rated Duty	Uninterrupted Duty
Rated Short-time withstand current and duration	1.2kA/1s
Rated Short-time withstand current and duration	2kA
Terminal Size	16mm <sup>2</sup>
Terminal Screw Type	Combination Flat/Philips head
Plate Colour (Finish)	Grey (Gloss)
Housing Material	Polycarbonate (PC)
Standards Complied	AS 60947.3, AS 3133

## KASTA Unison Atmos Weatherproof Switches

Unison Atmos Weatherproof Switch, 1 and 2 Gang, 16A, 250V a.c., IP66, Grey



PRODUCT CODE	PRODUCT TYPE	SAP CODE
ATS116-GY	Single	5000329
ATS116/2-GY	Double	5000330

SPECIFICATIONS	
Power Supply	220-240V a.c. 50Hz
IP Rating:	IP66
Current Rating	16A
Terminal Size	4.1mm bore (accommodates 4x1.5mm <sup>2</sup> cables)
Terminal Screw Type	Combination Flat/Philips head
Frame Colour (Finish)	Grey (Gloss)
Plate Colour (Finish)	Grey (Gloss)
Housing Material	Polycarbonate (PC)
Standards Complied	AS/NZS 3133

## KASTA Unison Atmos Weatherproof Powerpoint

Unison Atmos Weatherproof Powerpoint,  
Single and Double, Square, 10A 250V a.c.,  
IP54, Grey



PRODUCT CODE	PRODUCT TYPE	SAP CODE
ATPP1-GY	Single	5000251
ATPP1S-GY	Single Square	5000250
ATPP2N-GY	Double	5000252
ATPP2X-GY	Double Extra Switch	5000253

SPECIFICATIONS	
Power Supply	220-240V a.c.
IP Rating	IP54
Current Rating	10A
Terminal Size	16mm <sup>2</sup> (accommodates 4x2.5mm <sup>2</sup> cables)
Terminal Screw Type	Combination Flat/Phillips head
Frame Colour (Finish)	Grey (Gloss)
Plate Colour (Finish)	Grey (Gloss)
Housing Material	Polycarbonate (PC)
Standards Complied	AS/NZS 3112

Find out more

