

WEATHERPROOF BATTENS

TRIPROOF ^{G2}	120
TRIPROOF ^{YG}	124
DURA	126
DURA ^{FOREMAN}	130
SENTRY	132
ACCESSORIES	134

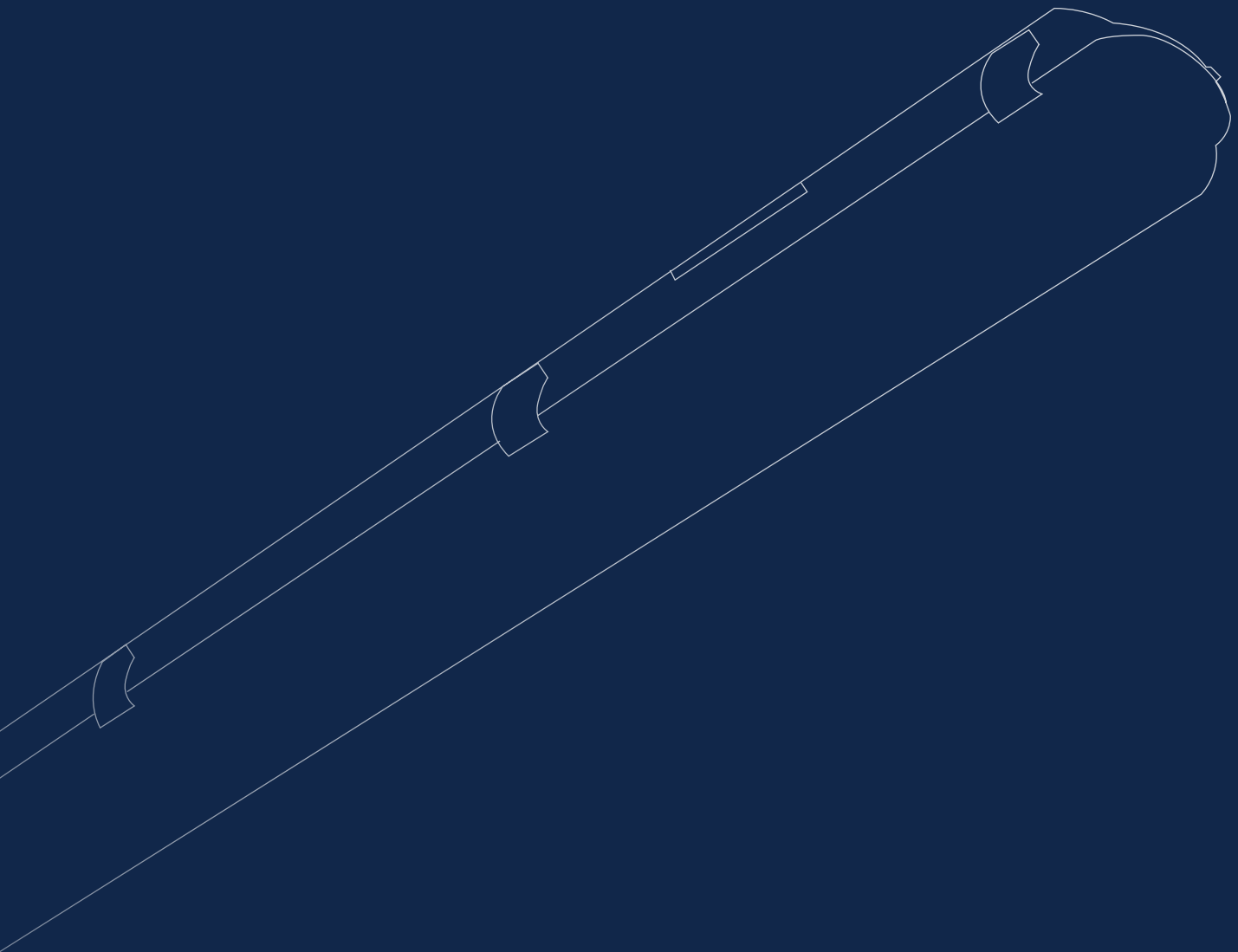



Project: CMI Toyota Southside, SA
Provider / Installer: TMK Consulting Engineers & Dead Short Electrical

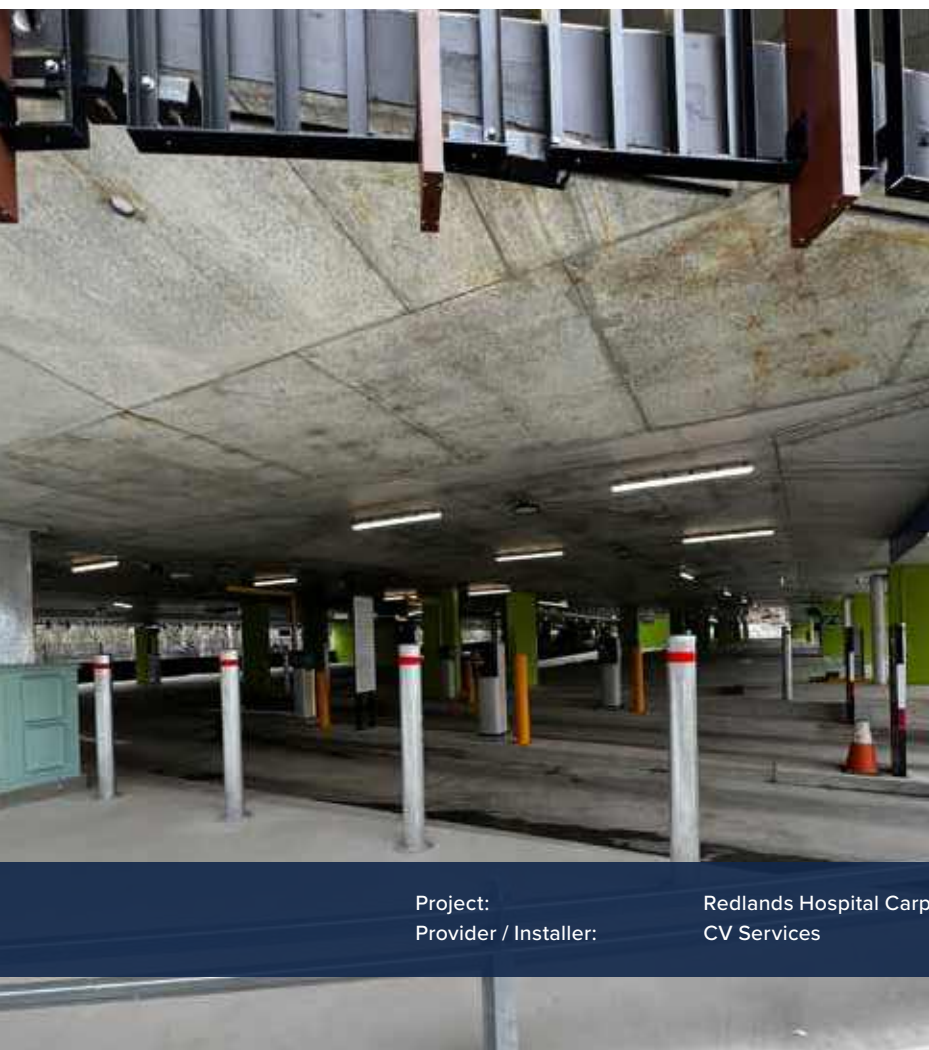

Project:
Provider / Installer:

Redlands Hospital Carpark, QLD
CV Services



TRIPROOF

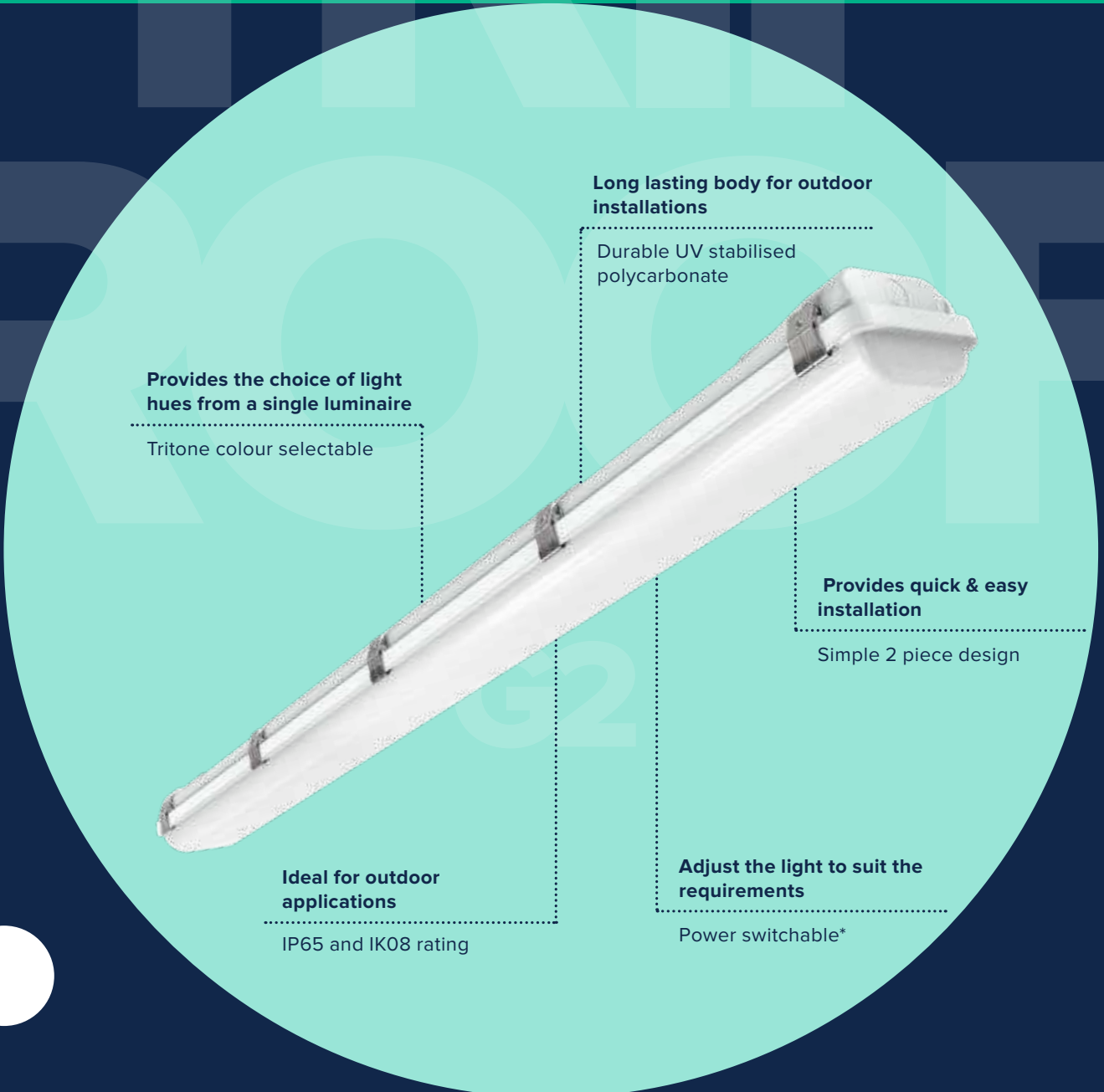

Long lasting body for outdoor installations

Durable UV stabilised polycarbonate

Provides the choice of light hues from a single luminaire

Tritone colour selectable

Provides quick & easy installation

Simple 2 piece design

Ideal for outdoor applications

IP65 and IK08 rating

Adjust the light to suit the requirements

Power switchable*

TRIPROOF^{G2}

Tried and trusted design.

Experience the power of TRIPROOF G2 LED battens, the ultimate weatherproof lighting solution engineered for demanding environments. These robust battens are built to withstand the toughest conditions, making them perfect for industrial settings including manufacturing facilities, as well as any outdoor area where reliability and durability are paramount.

*Model dependent

4POWER
Switchable Modes

TRITONE
Colour Selectable

IP65
Ingress Protection Rating

IK08
Impact Rating

50,000hr
Projected Lifespan

5yr
Warranty

PRODUCT RANGE



Product Code	TRIPROOF06	TRIPROOF06-EM	TRIPROOF12	TRIPROOF12-EM
SAP Code	2002550	2002551	2002552	2002554
Power	10 / 13 / 17 / 20 W	10 / 13 / 17 / 20 W	20 / 26 / 34 / 40 W	20 / 40 W
Lumen Output	10 W: 1204 / 1288 / 1268 lm 13 W: 1510 / 1640 / 1596 lm 17 W: 1928 / 2130 / 2037 lm 20 W: 2188 / 2442 / 2313 lm	10 W: 1210 / 1296 / 1274 lm 13 W: 1517 / 1646 / 1602 lm 17 W: 1934 / 2133 / 2046 lm 20 W: 2191 / 2453 / 2322 lm	20 W: 2716 / 2891 / 2841 lm 26 W: 3332 / 3618 / 3515 lm 34 W: 3821 / 4207 / 4050 lm 40 W: 4404 / 4872 / 4626 lm	20 W: 2386 / 2538 / 2513 lm 40 W: 4312 / 4724 / 4546 lm
Efficacy	10 W: 123 / 137 / 129 lm/W 13 W: 121 / 137 / 127 lm/W 17 W: 115 / 134 / 121 lm/W 20 W: 111 / 132 / 117 lm/W	10 W: 121 / 129 / 127 lm/W 13 W: 117 / 127 / 123 lm/W 17 W: 114 / 125 / 120 lm/W 20 W: 110 / 123 / 116 lm/W	20 W: 131 / 146 / 137 lm/W 26 W: 126 / 143 / 132 lm/W 34 W: 121 / 141 / 128 lm/W 40 W: 117 / 138 / 123 lm/W	20 W: 115 / 125 / 120 lm/W 40 W: 108 / 124 / 113 lm/W
CCT	3000 / 4000 / 5000 K	3000 / 4000 / 5000 K	3000 / 4000 / 5000 K	3000 / 4000 / 5000 K
Dimensions	660 x 122 x 75 mm	660 x 122 x 75 mm	1220 x 122 x 75 mm	1220 x 122 x 75 mm
Weight	1.45 kg	1.70 kg	2.35 kg	2.50 kg
Product Colour	Grey	Grey	Grey	Grey
Model Variant	Standard	Emergency	Standard	Emergency
Dimmable	Non-Dimmable	Non-Dimmable	Non-Dimmable	Non-Dimmable
Operating Ambient Temperature	-20 to 45°C	0 to 45°C	-20 to 45°C	0 to 45°C



Product Code	TRIPROOF12-MS	TRIPROOF12-MS-EM	TRIPROOF60W15-TRI	TRIPROOF60W15-TRI-EM
SAP Code	2002553	2002555	2001170	2001171
Power	18 / 24 / 32 / 38 W	18 / 24 / 32 / 38 W	60 W	60 W
Lumen Output	18 W: 2244 / 2380 / 2363 lm 24 W: 2953 / 3175 / 3137 lm 32 W: 3793 / 4131 / 4017 lm 38 W: 4176 / 4563 / 4395 lm	18 W: 2227 / 2360 / 2340 lm 24 W: 2995 / 3200 / 3146 lm 32 W: 3806 / 4151 / 4038 lm 38 W: 4127 / 4517 / 4346 lm	5600 / 6000 / 5700 lm	5600 / 6000 / 5700 lm
Efficacy	18 W: 129 / 141 / 135 lm/W 24 W: 123 / 138 / 130 lm/W 32 W: 117 / 134 / 123 lm/W 38 W: 113 / 131 / 119 lm/W	18 W: 123 / 131 / 130 lm/W 24 W: 125 / 133 / 131 lm/W 32 W: 119 / 130 / 126 lm/W 38 W: 109 / 119 / 114 lm/W	93 / 100 / 95 lm/W	93 / 100 / 95 lm/W
CCT	3000 / 4000 / 5000 K	3000 / 4000 / 5000 K	4000 / 5000 / 6500 K	4000 / 5000 / 6500 K
Dimensions	1220 x 122 x 75 mm	1220 x 122 x 75 mm	1515 x 116 x 74 mm	1515 x 116 x 74 mm
Weight	2.35 kg	2.50 kg	3.50 kg	3.70 kg
Product Colour	Grey	Grey	Grey	Grey
Model Variant	Intellisensor	Intellisensor + Emergency	Standard	Emergency
Dimmable	Non-Dimmable	Non-Dimmable	Non-Dimmable	Non-Dimmable
Operating Ambient Temperature	-20 to 45°C	0 to 45°C	-20 to 45°C	0 to 45°C

Find out more



COMMON SPECIFICATIONS

Body Material	Polycarbonate	Input Voltage	220-240Vac, 50/60Hz
Diffuser Material	Polycarbonate (Opal)	Electrical Classification	Class I
IP Rating	IP65	Power Factor	> 0.9
IK Rating	IK08	Protection	Overload / Short Circuit
Beam Angle	120°	Projected Lifespan	> 50,000hrs @Ta45°C (L80)
CRI	> 85	Smart	KASTA Compatible
SDCM	< 3	Dimming	Non-Dimmable
Driver	Integral		0-10V, Dali and Dali Emergency versions available.
Power Connection	PA14 Terminals		

APPLICATIONS

Carpark
 Balconies / Patios / Verandah
 Awnings
 Garage
 Shed
 Carport
 Storage Rooms
 Hangers
 Manufacturing Facilities
 Public Facilities
 Temporary Installations
 Cool Rooms
 Outdoor Recreation
 Indoor Recreation
 General Industrial
 Kitchen / Food Prep

ACCESSORIES

Mounting Supports



1m Suspension Kit
TSSKIT-1M
 (SAP 2000863)



2m Suspension Kit
TSSKIT-2M
 (SAP 2000864)

DIMENSIONS

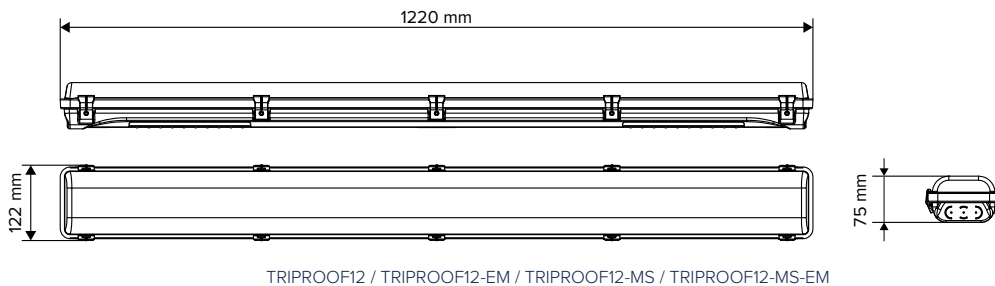
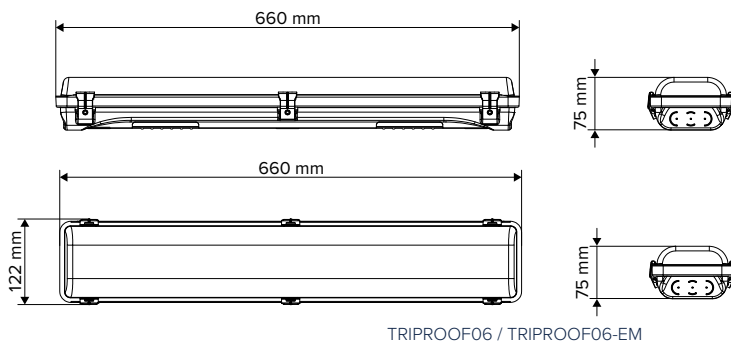



TRIPROOF

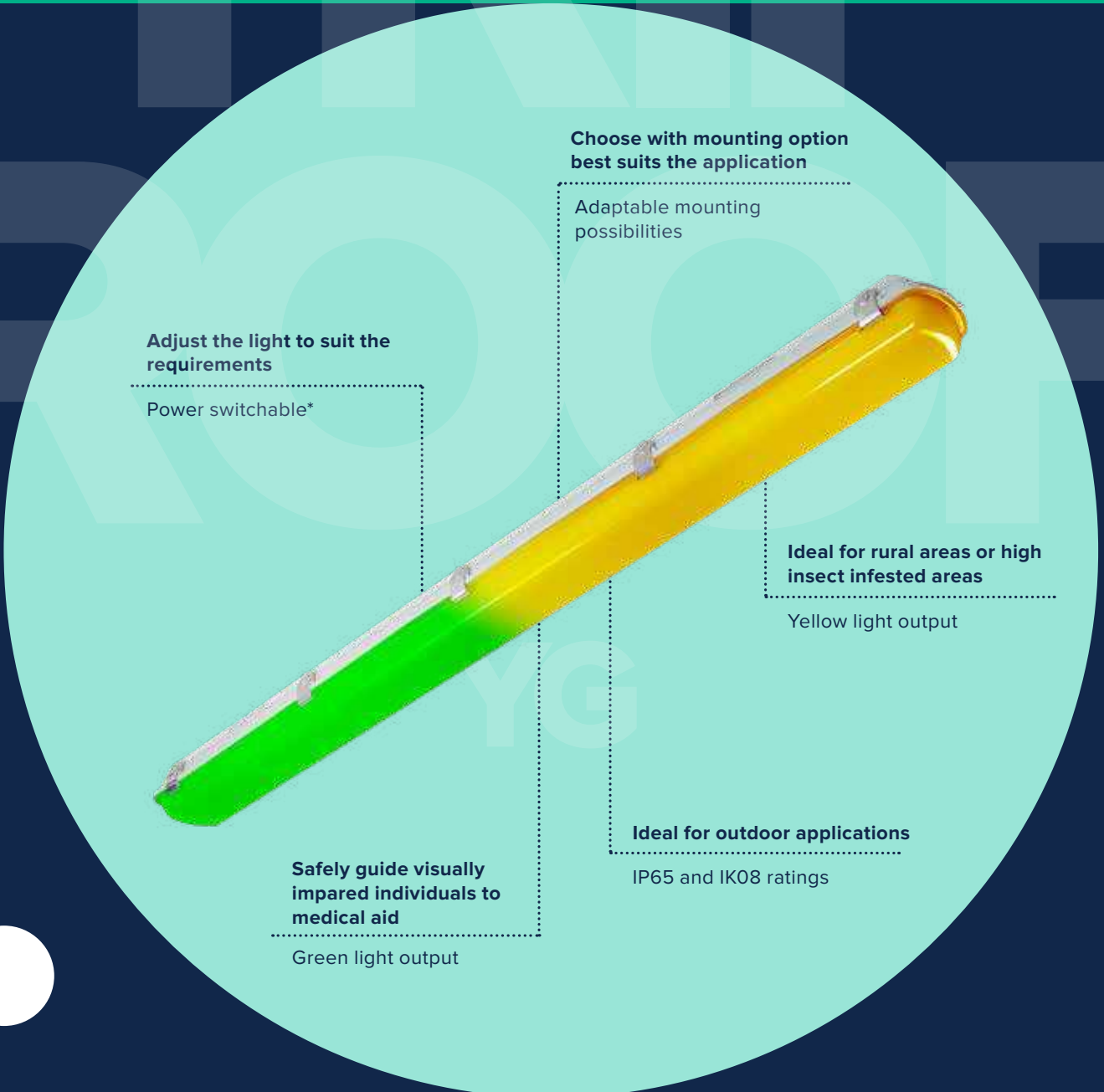

Choose with mounting option best suits the application

Adaptable mounting possibilities

Adjust the light to suit the requirements

Power switchable*

Ideal for rural areas or high insect infested areas

Yellow light output

Ideal for outdoor applications

IP65 and IK08 ratings

Safely guide visually impaired individuals to medical aid

Green light output

TRIPROOF^{YG}

Tried and trusted design.

TRIPROOF YG are weatherproof LED battens with a striking robust design and suitability for higher ambient temperatures. This model offers a specific Yellow colour output suitable for attracting fewer insects than traditional white lights, and a specific Green colour output suitable for eyewash bays.

The rendering image above is for reference only and does not represent the actual colour output on the luminaire.
*Model dependent



Yellow Green
Colour Temperature



IP65
Ingress Protection Rating



IK08
Impact Rating



120°
Beam Angle



50,000hr
Projected Lifespan



5yr
Warranty

PRODUCT RANGE



Product Code	TRIPROOF06-YG	TRIPROOF06-YG-EM	TRIPROOF12-YG	TRIPROOF12-YG-EM
SAP Code	2002301	2002302	2002303	2002304
Power	20 W	20 W	20 / 40 W	20 / 40 W
Lumen Output	G: 2072 lm Y: 2262 lm	G: 2129 lm Y: 2209 lm	20W: G: 2256 / Y: 2564 lm 40W: G: 4431 / Y: 4634 lm	20W: G: 2500 / Y: 2530 lm 40W: G: 4226 / Y: 4708 lm
Efficacy	G: 114 lm/W Y: 127 lm/W	G: 103 lm/W Y: 111 lm/W	20W: G: 140 / Y: 143 lm/W 40W: G: 117 / Y: 127 lm/W	20W: G: 122 / Y: 125 lm/W 40W: G: 107 / Y: 120 lm/W
Dimensions	618 x 116 x 74 mm	618 x 116 x 74 mm	1215 x 116 x 74 mm	1215 x 116 x 74 mm
Weight	1.30 kg	1.55 kg	2.40 kg	2.65 kg
Product Colour	Grey	Grey	Grey	Grey
Model Variant	Standard	Emergency	Standard	Emergency
Operating Ambient Temperature	-20 to 45°C	0 to 45°C	-20 to 45°C	0 to 45°C

COMMON SPECIFICATIONS

Body Material	Polycarbonate	Electrical Classification	Class I
Diffuser Material	Polycarbonate (Opal)	Power Factor	> 0.9
IP Rating	IP65	Protection	Overload / Short Circuit
IK Rating	IK08	Projected Lifespan	> 50,000hrs @Ta25°C (L70)
Beam Angle	120°	Smart	KASTA Compatible
Driver	Integral	Dimming	Non-Dimmable
Power Connection	PA14 Terminals		
Input Voltage	220-240Vac, 50/60Hz		

APPLICATIONS

- Wash Bay
- Mining Sites
- Side of Building
- Manufacturing Facilities
- General Industrial
- Medical Facilities

ACCESSORIES

Mounting Supports



1m Suspension Kit
TSSKIT-1M
(SAP 2000863)



2m Suspension Kit
TSSKIT-2M
(SAP 2000864)

Emergency Battery



Battery
LI-BATTERY-BATTEN
(SAP 2001908)

DIMENSIONS

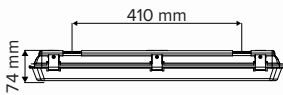
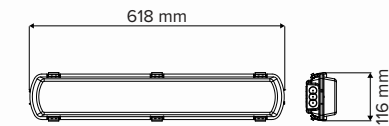

TRIPROOF06-YG / TRIPROOF06-YG-EM

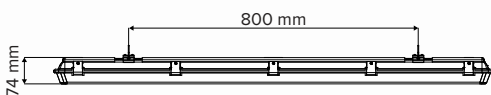
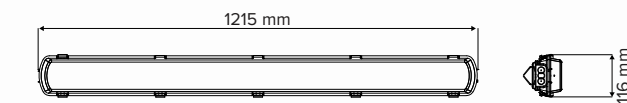

TRIPROOF12-YG / TRIPROOF12-YG-EM

Find out more



DURA

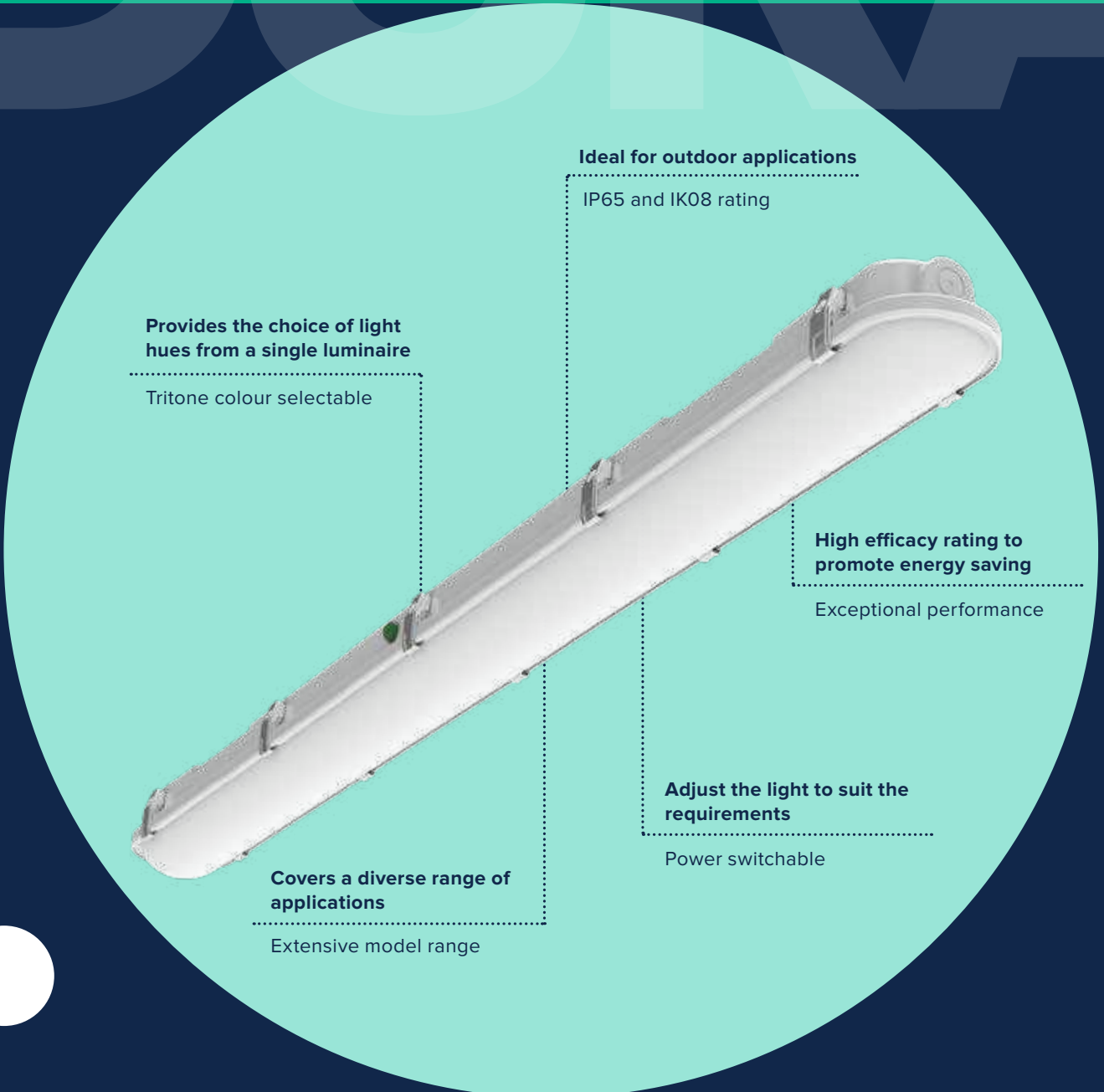

Ideal for outdoor applications

IP65 and IK08 rating

Provides the choice of light hues from a single luminaire

Tritone colour selectable

High efficacy rating to promote energy saving

Exceptional performance

Adjust the light to suit the requirements

Power switchable

Covers a diverse range of applications

Extensive model range

DURA

Robust construction for harsh environments.

The DURA batten features IP65 ingress protection, IK08 impact resistance which makes it the right choice for industrial and utility-type applications such as car parks, workshops, storerooms and back of house areas. Featuring a unique foldable structure and two-piece design for ease of installation.

4POWER
Switchable Modes

IP65
Ingress Protection Rating

IK08
Impact Rating

HACCP*
INTERNATIONAL Food Safe

50,000hr
Projected Lifespan

5yr
Warranty

PRODUCT RANGE



Product Code	DURA-06	DURA-06-EM	DURA-06-MS	DURA-06-EM-MS
SAP Code	2002138	2002139	2002140	2002141
Power	10 / 13 / 15 / 18 W	10 / 13 / 15 / 18 W	10 / 13 / 15 / 18 W	10 / 13 / 15 / 18 W
Lumen Output	10 W: 1387 / 1431 / 1386 lm 13 W: 1693 / 1768 / 1671 lm 15 W: 1953 / 2050 / 1921 lm 18 W: 2155 / 2356 / 2177 lm	10 W: 1387 / 1431 / 1386 lm 13 W: 1693 / 1768 / 1671 lm 15 W: 1953 / 2050 / 1921 lm 18 W: 2155 / 2356 / 2177 lm	10 W: 1387 / 1431 / 1386 lm 13 W: 1693 / 1768 / 1671 lm 15 W: 1953 / 2050 / 1921 lm 18 W: 2155 / 2356 / 2177 lm	10 W: 1387 / 1431 / 1386 lm 13 W: 1693 / 1768 / 1671 lm 15 W: 1953 / 2050 / 1921 lm 18 W: 2155 / 2356 / 2177 lm
Efficacy	10 W: 139 / 143 / 139 lm/W 13 W: 136 / 129 / 130 lm/W 15 W: 130 / 137 / 128 lm/W 18 W: 120 / 131 / 121 lm/W	10 W: 139 / 143 / 139 lm/W 13 W: 136 / 129 / 130 lm/W 15 W: 130 / 137 / 128 lm/W 18 W: 120 / 131 / 121 lm/W	10 W: 139 / 143 / 139 lm/W 13 W: 136 / 129 / 130 lm/W 15 W: 130 / 137 / 128 lm/W 18 W: 120 / 131 / 121 lm/W	10 W: 139 / 143 / 139 lm/W 13 W: 136 / 129 / 130 lm/W 15 W: 130 / 137 / 128 lm/W 18 W: 120 / 131 / 121 lm/W
CCT	4000 / 4500 / 5000 K	4000 / 4500 / 5000 K	4000 / 4500 / 5000 K	4000 / 4500 / 5000 K
Dimensions	655 x 102 x 75 mm	655 x 102 x 75 mm	655 x 102 x 75 mm	655 x 102 x 75 mm
Weight	1.00 kg	1.30 kg	1.00 kg	1.30 kg
Product Colour	Grey	Grey	Grey	Grey
Model Variant	Standard	Emergency	Intellisensor	Intellisensor + Emergency
Operating Ambient Temperature	-10 to 40°C	0 to 40°C	-10 to 40°C	0 to 40°C



Product Code	DURA-12	DURA-12-EM	DURA-12-MS	DURA-12-EM-MS
SAP Code	2002142	2002143	2002144	2002145
Power	18 / 25 / 30 / 36 W	18 / 25 / 30 / 36 W	18 / 25 / 30 / 36 W	18 / 25 / 30 / 36 W
Lumen Output	18 W: 2425 / 2474 / 2474 lm 25 W: 3089 / 3242 / 3083 lm 30 W: 3706 / 3917 / 3726 lm 36 W: 4318 / 4627 / 4367 lm	18 W: 2425 / 2474 / 2474 lm 25 W: 3089 / 3242 / 3083 lm 30 W: 3706 / 3917 / 3726 lm 36 W: 4318 / 4627 / 4367 lm	18 W: 2425 / 2474 / 2474 lm 25 W: 3089 / 3242 / 3083 lm 30 W: 3706 / 3917 / 3726 lm 36 W: 4318 / 4627 / 4367 lm	18 W: 2425 / 2474 / 2474 lm 25 W: 3089 / 3242 / 3083 lm 30 W: 3706 / 3917 / 3726 lm 36 W: 4318 / 4627 / 4367 lm
Efficacy	18 W: 135 / 137 / 137 lm/W 25 W: 124 / 130 / 123 lm/W 30 W: 124 / 131 / 124 lm/W 36 W: 120 / 129 / 121 lm/W	18 W: 135 / 137 / 137 lm/W 25 W: 124 / 130 / 123 lm/W 30 W: 124 / 131 / 124 lm/W 36 W: 120 / 129 / 121 lm/W	18 W: 135 / 137 / 137 lm/W 25 W: 124 / 130 / 123 lm/W 30 W: 124 / 131 / 124 lm/W 36 W: 120 / 129 / 121 lm/W	18 W: 135 / 137 / 137 lm/W 25 W: 124 / 130 / 123 lm/W 30 W: 124 / 131 / 124 lm/W 36 W: 120 / 129 / 121 lm/W
CCT	4000 / 4500 / 5000K	4000 / 4500 / 5000K	4000 / 4500 / 5000K	4000 / 4500 / 5000K
Dimensions	1220 x 102 x 75 mm	1220 x 102 x 75 mm	1220 x 102 x 75 mm	1220 x 102 x 75 mm
Weight	2.00 kg	2.40 kg	2.00 kg	2.40 kg
Product Colour	Grey	Grey	Grey	Grey
Model Variant	Standard	Emergency	Intellisensor	Intellisensor + Emergency
Operating Ambient Temperature	-10 to 40°C	0 to 40°C	-10 to 40°C	0 to 40°C

Find out more



COMMON SPECIFICATIONS

Body Material	Polycarbonate	Power Connection	PA14 Terminals
Diffuser Material	Polycarbonate (Opal)	Input Voltage	220-240Vac, 50/60Hz
IP Rating	IP65	Electrical Classification	Class I
IK Rating	IK08	Protection	Overload / Short Circuit
Food Grade Approval	HACCP*	Projected Lifespan	> 50,000hrs @Ta25°C (L70)
Beam Angle	120°	Smart	KASTA Compatible
CRI	> 85	Dimming	Non-Dimmable
SDCM	< 3		
Driver	Integral		
Power Factor	> 0.9		

APPLICATIONS

Carpark
 Kitchen / Food Prep
 Balconies / Patios / Verandah
 Garage
 Awnings
 Shed
 Side of Building
 Carport
 Storage Rooms
 Warehouse
 Storage Facilities
 Hangers
 Manufacturing Facilities
 Public Facilities
 Temporary installations
 General Industrial

ACCESSORIES

Mounting Supports



1m Suspension Kit
TSSKIT-1M
 (SAP 2000863)



2m Suspension Kit
TSSKIT-2M
 (SAP 2000864)

Tooling Accessories



Hex Key
DURA-HEXKEY
 (SAP 2002237)

DIMENSIONS

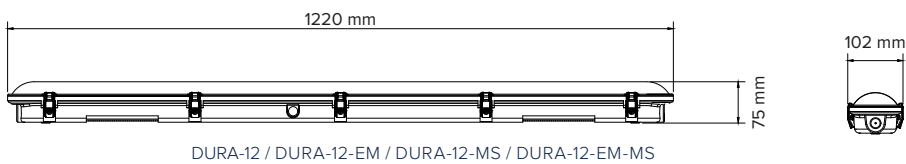
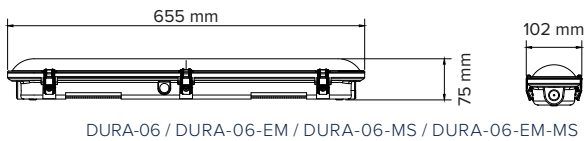



DURA

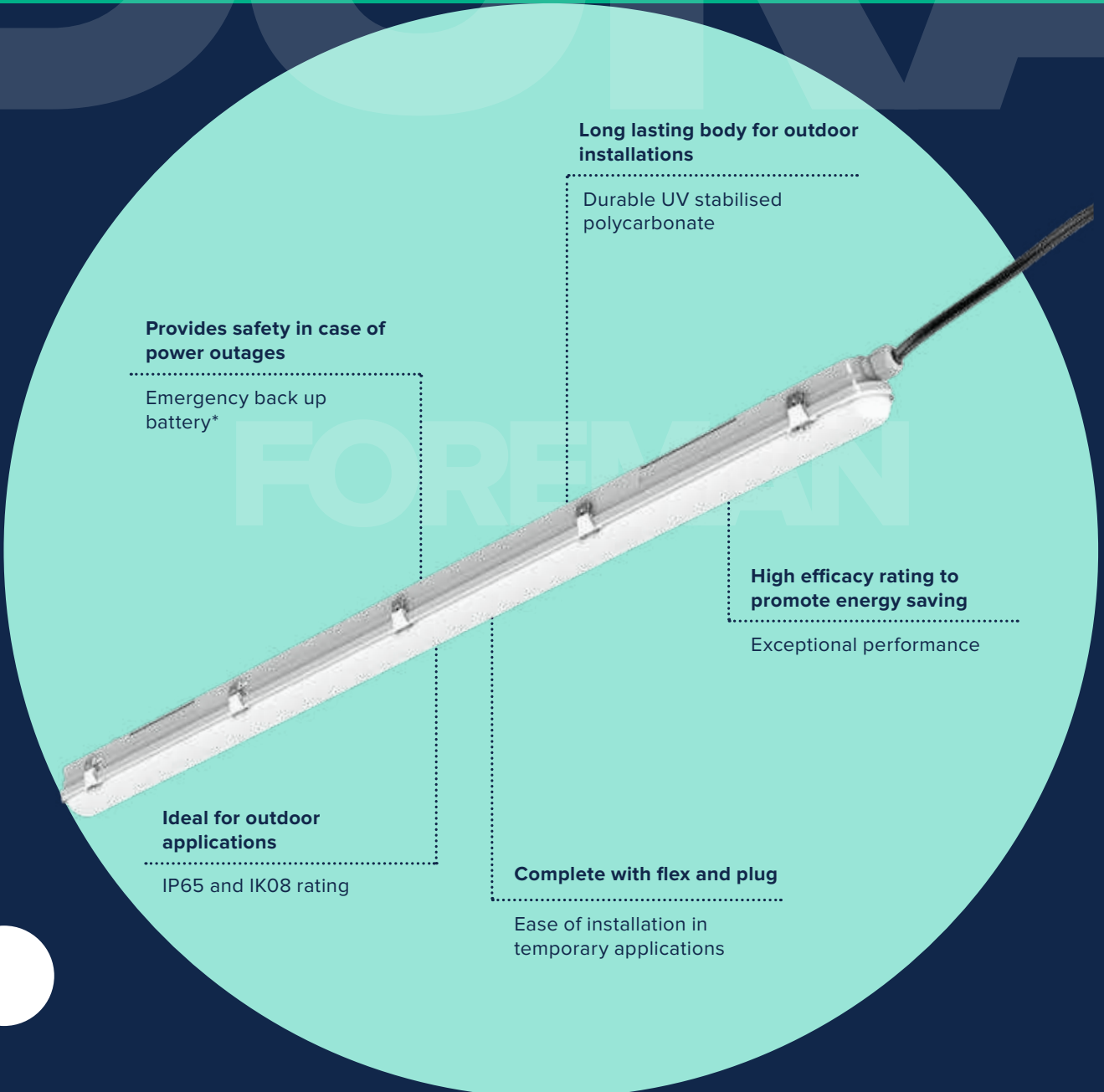

Long lasting body for outdoor installations

Durable UV stabilised polycarbonate

Provides safety in case of power outages

Emergency back up battery*

High efficacy rating to promote energy saving

Exceptional performance

Ideal for outdoor applications

IP65 and IK08 rating

Complete with flex and plug

Ease of installation in temporary applications

DURA FOREMAN

Temporary weatherproof solution.

Illuminate your construction site with the DURA FOREMAN, an energy-efficient weatherproof batten designed for temporary applications. Perfect for commercial, residential, and infrastructure projects, the DURA FOREMAN offers a safe and flexible lighting solution.

*Model dependent



PRODUCT RANGE



Product Code	DURA-12-FRMN	DURA-12-FRMN-EM
SAP Code	2002543	2002544
Power	36 W	36 W
Lumen Output	4094 lm	Standard Mode: 4094 lm EM Mode: 223 lm
Efficacy	115 lm/W	115 lm/W
CCT	4000 K	4000 K
Dimensions	1220 x 69 x 67 mm	1220 x 69 x 67 mm
Weight	1.11 kg	1.30 kg
Product Colour	Grey	Grey
Model Variant	Standard	Emergency
Operating Ambient Temperature	-15 to 40°C	-0 to 40°C

COMMON SPECIFICATIONS

Body Material	Polycarbonate	Input Voltage	220-240Vac, 50/60Hz
Diffuser Material	Polycarbonate (Opal)	Electrical Classification	Class I
IP Rating	IP65	Power Factor	> 0.9
IK Rating	IK08	Protection	Overload / Short Circuit
CRI	> 80	Projected Lifespan	> 50,000hrs @Ta25°C (L70)
SDCM	< 5	Smart	KASTA Compatible
Beam Angle	120°	Dimming	Non-Dimmable
Driver	Integral		
Power Connection	Complete with flex and plug		

APPLICATIONS

Temporary Installations

DIMENSIONS

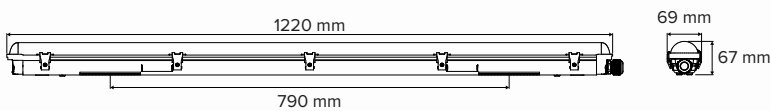

DURA-12-FRMN / DURA-12-FRMN-EM

Find out more



SENTRY

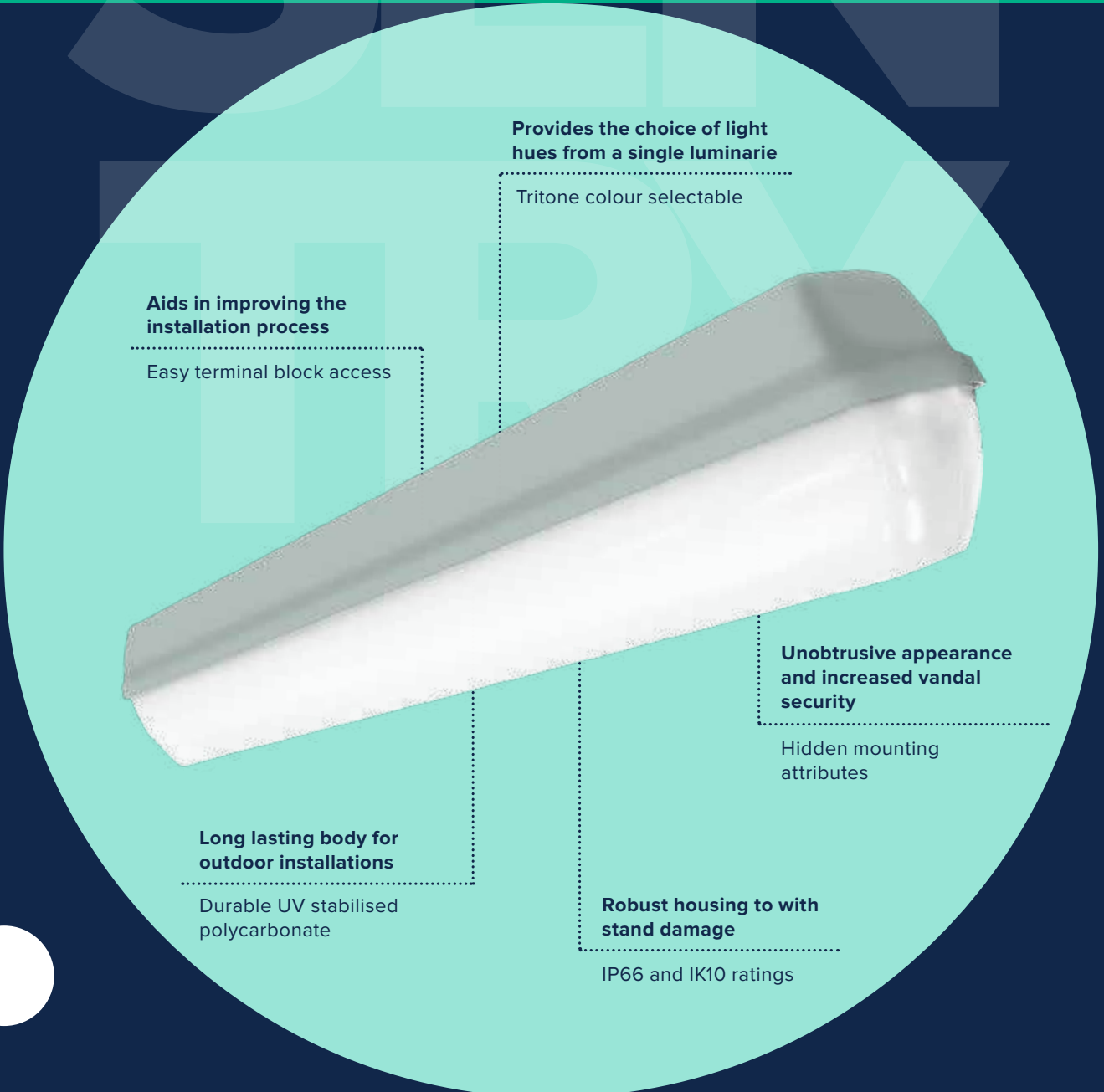

Provides the choice of light hues from a single luminaire

Tritone colour selectable

Aids in improving the installation process

Easy terminal block access

Unobtrusive appearance and increased vandal security

Hidden mounting attributes

Long lasting body for outdoor installations

Durable UV stabilised polycarbonate

Robust housing to with stand damage

IP66 and IK10 ratings

SENTRY

Vandal proof and secure.

SENTRY is a sturdy and vandal proof security fitting. It features a robust polycarbonate body and diffuser, designed to withstand the toughest environments. SENTRY is ideal for public areas, schools and community centres.

TRITONE
Colour Selectable

IP66*
Ingress Protection Rating

IK10
Impact Rating

Flicker
Free

120°
Beam Angle

3yr*
Warranty

*Model dependent

PRODUCT RANGE



Product Code	SENTRY12W06-TRI	SENTRY40W12-TRI
SAP Code	2001495	2002586
Power	12 W	22 / 40 W
Lumen Output	1010 / 1225 / 1201 lm	22 W: 2420 / 2860 / 2640 lm 40 W: 4400 / 5200 / 4800 lm
Efficacy	84 / 102 / 100 lm/W	22 W: 2420 / 2860 / 2640 lm 40 W: 4400 / 5200 / 4800 lm
CCT	TBC	3000 / 4000 / 5000 K
Dimensions	675 x 96 x 116 mm	1285 x 96 x 115 mm
Weight	1.46 kg	2.54 kg
Product Colour	Grey	Grey
IP Rating	IP66	IP65
Projected Lifespan	> 36,000hrs @Ta25°C (L70)	54,000hrs @ 25°C (L70)

COMMON SPECIFICATIONS

Body Material	Polycarbonate
Diffuser Material	Polycarbonate (Opal)
IK Rating	IK10
Beam Angle	120°
CRI	> 80
Driver	Integral
Power Connection	PA14 Terminals
Input Voltage	220-240Vac, 50/60Hz

Electrical Classification	Class I
Power Factor	> 0.9
Protection	Overload / Short Circuit
Operating Ambient Temperature	-15 to 45°C
Smart	KASTA Compatible
Dimming	Non-Dimmable

APPLICATIONS

Manufacturing Facilities
Indoor Recreation
Public Facilities
Side of Building
Area Lighting

DIMENSIONS

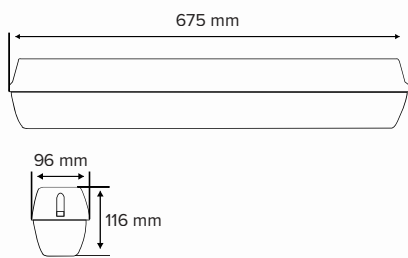

SENTRY12W06-TRI

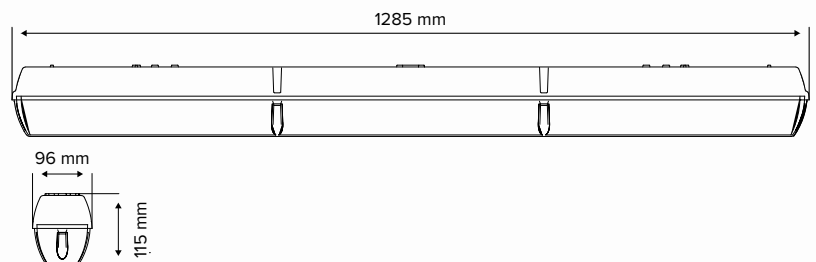

SENTRY40W12-TRI

Find out more



Accessories

MOUNTING SUPPORTS



Product Code	TSSKIT-1M	TSSKIT-2M
SAP Code	2000863	2000864
Type	1m Suspension Kits	2m Suspension Kits
Compatible With	DURA (all models) TRIPROOF ^{G2} (all models) TRIPROOF ^{YG} (all models)	DURA (all models) TRIPROOF ^{G2} (all models) TRIPROOF ^{YG} (all models)

EMERGENCY BATTERY



Product Code	LI-BATTERY-BATTEN
SAP Code	2001908
Type	Emergency Battery
Compatible With	TRIPROOF ^{YG} (all EM models)
Description	LiFePo4 Lithium 3.2v 3.3Ah 10.56 Wh Battery

ACCESSORIES AND TOOLING



Product Code	DURA-HEXKEY
SAP Code	2002237
Type	Hex Key
Compatible With	DURA (all models)

